



MODEL S

OWNER'S MANUAL



Software version: 2020.44
Australia

SAFETY INFORMATION

The Model S Owner's Manual is available on the touchscreen. To view it, touch **Controls > Owner's Manual**.

For detailed information about your Model S, go to www.tesla.com, and log on to your Tesla Account, or sign up to get an account.

If you have any questions or concerns about your Model S, call 1-877-79TESLA (1-877-798-3752).

DOCUMENT APPLICABILITY

Features released in the most recent versions of software may not be described in this document but are described in Release Notes. Display Release Notes on the touchscreen by touching the Tesla T at the top center of the touchscreen, then touching the Release Notes link. If information provided in this document conflicts with information in the Release Notes, the Release Notes take precedence. ILLUSTRATIONS The illustrations provided in this document are for demonstration purposes only. Depending on vehicle options, software version and market region, the information displayed on the touchscreen in your vehicle may appear slightly different.

PRODUCT SPECIFICATIONS

All specifications and descriptions contained in this document are verified to be accurate at the time of printing. However, because continuous improvement is a goal at Tesla, we reserve the right to make product modifications at any time. To communicate any inaccuracies or omissions in this document, please send an email to: ownersmanualfeedback@tesla.com.

© 2012-2020 TESLA, INC.

All information in this document and all vehicle software is subject to copyright and other intellectual property rights of Tesla, Inc. and its licensors. This material may not be modified, reproduced or copied, in whole or in part, without the prior written permission of Tesla, Inc. and its licensors. Additional information is available upon request. The following are trademarks or registered trademarks of Tesla, Inc. in the United States and other countries:

TESLA, TESLA MOTORS, MODEL S, MODEL X, ROADSTER, MODEL 3, MODEL Y

Overview.....	2	Using the Touchscreen.....	117
Interior Overview.....	2	Controls.....	117
Exterior Overview.....	4	Climate Controls.....	123
Touchscreen Overview.....	5	Maps and Navigation.....	128
Opening and Closing.....	10	Media and Audio.....	133
Keys and Doors.....	10	Phone.....	136
Windows.....	14	Air Suspension.....	138
Rear Trunk.....	15	Calendar.....	140
Front Trunk.....	17	Security Settings.....	141
Interior Storage and Electronics.....	19	HomeLink Universal Transceiver.....	145
Sunroof.....	22	Connecting to Wi-Fi.....	147
Seating and Safety Restraints.....	23	Software Updates.....	148
Front and Rear Seats.....	23	Mobile App.....	150
Seat Belts.....	25	Charging.....	152
Child Safety Seats.....	27	Electric Vehicle Components.....	152
Airbags.....	34	Battery Information.....	154
Driving.....	37	Charging Instructions.....	155
Driver Profiles.....	37	Maintenance.....	160
Steering Wheel.....	39	Maintenance Schedule.....	160
Mirrors.....	42	Tire Care and Maintenance.....	162
Starting and Powering Off.....	44	Cleaning.....	167
Gears.....	46	Wiper Blades and Washer Jets.....	170
Lights.....	48	Fluid Reservoirs.....	171
Instrument Panel.....	52	Jacking and Lifting.....	174
Wipers and Washers.....	58	Parts and Accessories.....	175
Braking and Stopping.....	59	Specifications.....	176
Traction Control.....	63	Identification Labels.....	176
Park Assist.....	64	Vehicle Loading.....	177
Vehicle Hold.....	66	Dimensions and Weights.....	179
Acceleration Modes.....	67	Subsystems.....	181
Active Hood.....	69	Wheels and Tires.....	184
Trip Information.....	70	Roadside Assistance.....	188
Getting Maximum Range.....	71	Contacting Tesla Roadside Assistance.....	188
Rear View Camera.....	73	Instructions for Transporters.....	189
Dashcam.....	74	Consumer Information.....	192
Cold Weather Best Practices.....	77	Easter Eggs.....	192
Autopilot.....	79	About this Owner Information.....	193
About Autopilot.....	79	Disclaimers.....	194
Traffic-Aware Cruise Control.....	82	Reporting Safety Defects.....	195
Autosteer.....	87	Declarations of Conformity.....	196
Navigate on Autopilot.....	91	Troubleshooting Alerts.....	201
Traffic Light and Stop Sign Control.....	94	Index.....	221
Autopark.....	101		
Summon.....	103		
Smart Summon.....	106		
Lane Assist.....	109		
Collision Avoidance Assist.....	112		
Speed Assist.....	115		



Interior Overview

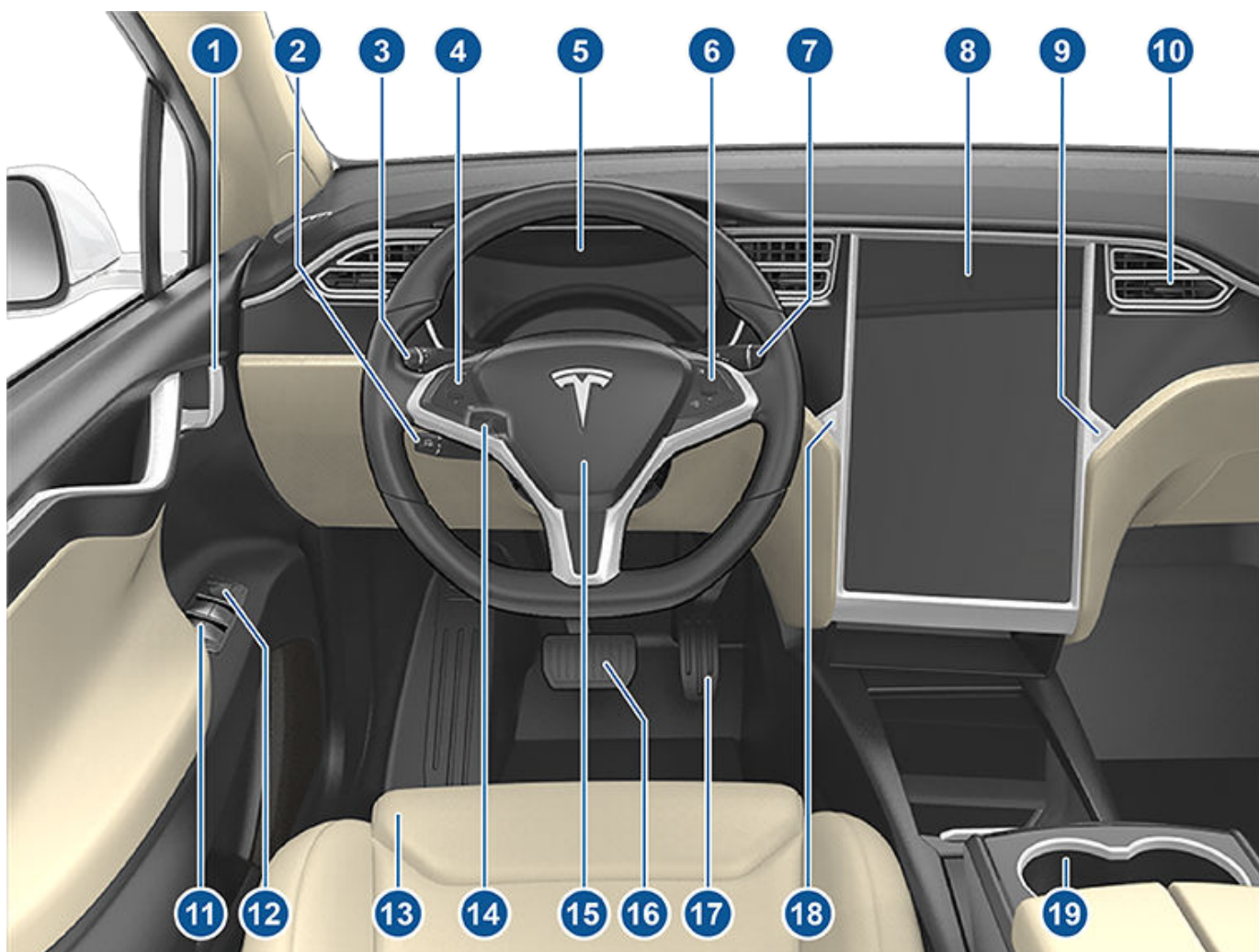

NOTE: On RHD (Right Hand Drive) vehicles, the controls illustrated above are arranged similarly, but are mirrored on the right side of the vehicle.

1. Interior door handles ([Opening Doors from the Interior on page 12](#))
2. Autopilot stalk ([Traffic-Aware Cruise Control on page 82](#) and [Autosteer on page 87](#))
3. Turn signal stalk ([High Beam Headlights on page 50](#), [Turn Signals on page 50](#), [Wipers and Washers on page 58](#))
4. Steering wheel buttons - left ([Using Left Steering Wheel Buttons on page 39](#))
5. Instrument panel ([Instrument Panel on page 52](#))
6. Steering wheel buttons - right ([Using Right Steering Wheel Buttons on page 40](#))
7. Drive stalk ([Shifting Gears on page 46](#))
8. Touchscreen ([Touchscreen Overview on page 5](#))
9. Glovebox button ([Glovebox on page 19](#))
10. Cabin climate control ([Climate Controls on page 123](#))
11. Power window switches ([Opening and Closing on page 14](#))
12. Exterior mirror adjustment switches ([Mirrors on page 42](#))
13. Seats ([Front and Rear Seats on page 23](#))
14. Steering column adjuster (hidden from view in the above image) ([Steering Wheel on page 39](#))
15. Horn ([Horn on page 41](#))
16. Brakes ([Braking and Stopping on page 59](#))



- 17. Accelerator pedal ([Acceleration Modes on page 67](#))
- 18. Hazard warning lights ([Hazard Warning Flashers on page 51](#))
- 19. Cup holders ([Cup Holders on page 21](#))



Exterior Overview

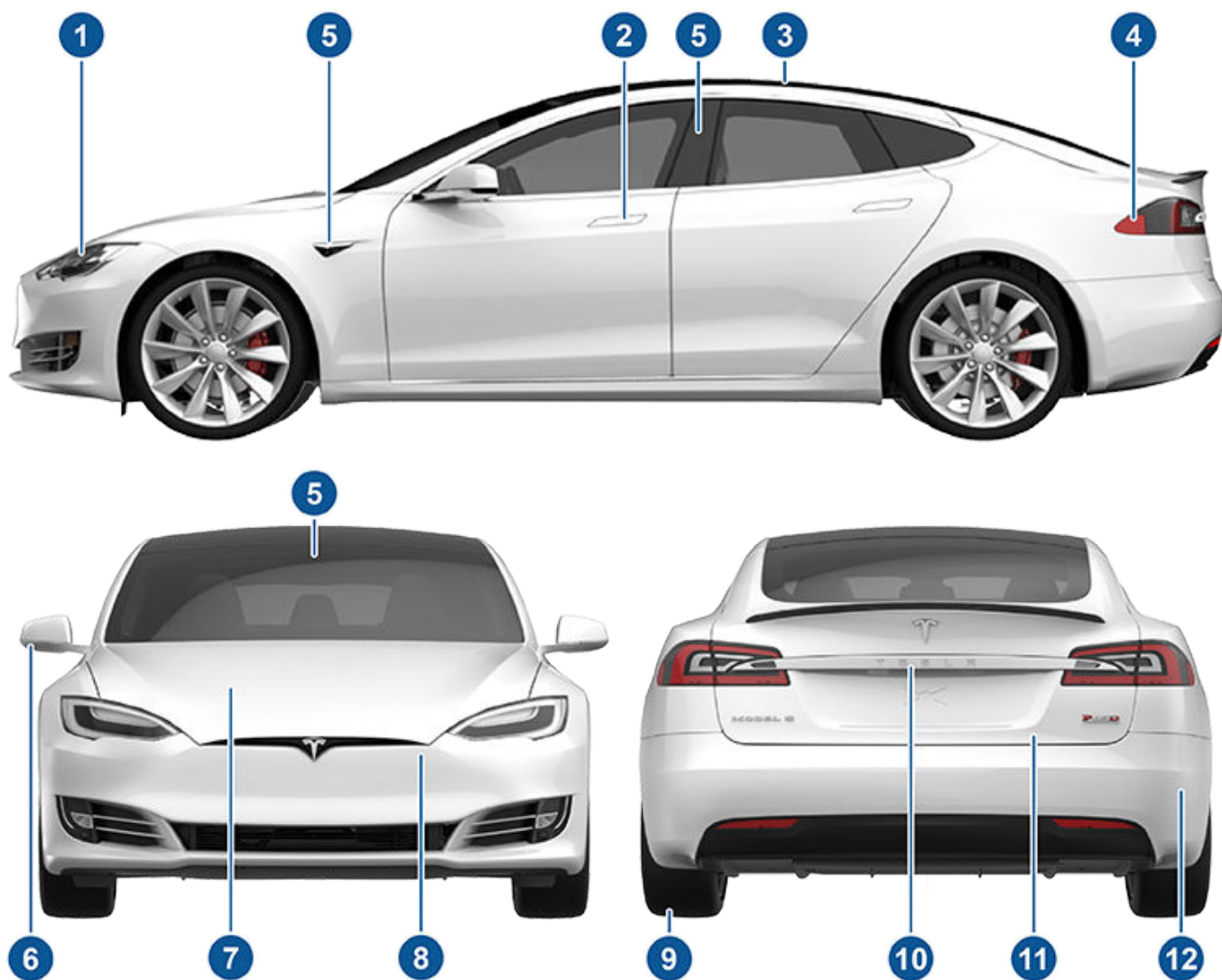

1. Exterior lights ([Lights on page 48](#))
2. Door handles ([Using Exterior Door Handles on page 11](#))
3. Sunroof (optional) ([Sunroof on page 22](#))
4. Charge port ([Charging Instructions on page 155](#))
5. Autopilot cameras ([About Autopilot on page 79](#))
6. Exterior mirrors ([Mirrors on page 42](#))
7. Hood/Front trunk ([Front Trunk on page 17](#))
8. Radar sensor (hidden from view in the above image) ([About Autopilot on page 79](#))
9. Wheels and tires ([Wheels and Tires on page 184](#))
10. Rear view camera ([Rear View Camera on page 73](#) and [About Autopilot on page 79](#))
11. Rear trunk/liftgate ([Rear Trunk on page 15](#))
12. Ultrasonic sensors ([Park Assist on page 64](#) and [About Autopilot on page 79](#))



The main components of the touchscreen are shown here. The touchscreen is used to control many features that, in traditional cars, are controlled using physical buttons (for example, adjusting the heating and air conditioning, headlights, etc.). You can also use the touchscreen to customize Model S to suit your preferences.



WARNING: Always pay attention to road and traffic conditions when driving. To minimize driver distraction and ensure the safety of vehicle occupants as well as other road users, avoid using the touchscreen to adjust settings while the vehicle is in motion.





NOTE: *The image below is provided for demonstration purposes only. Depending on vehicle options, software version and market region, your touchscreen may appear slightly different.*

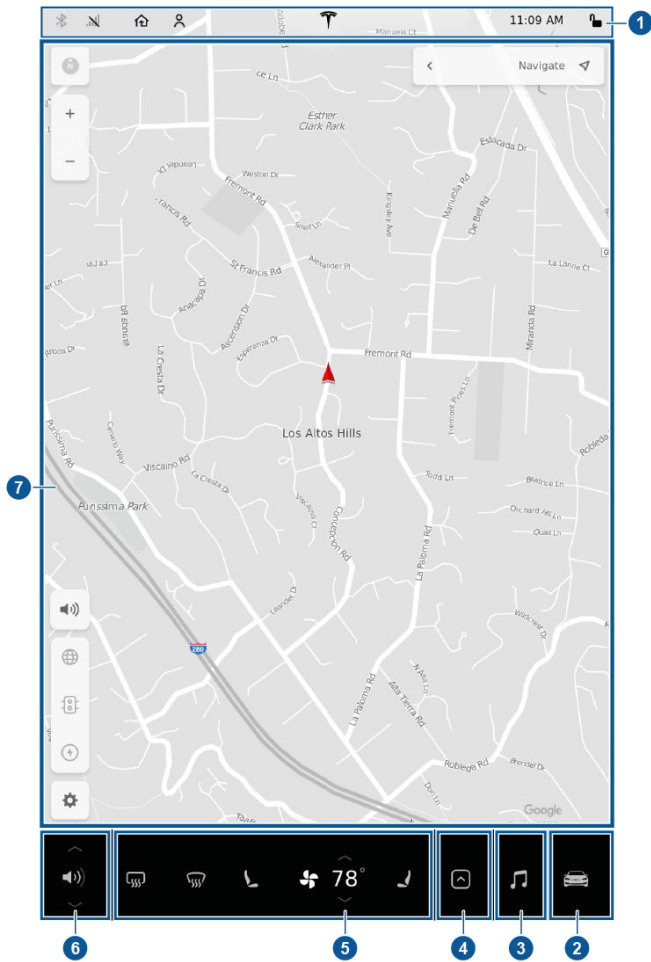









Touchscreen Overview



1. This area on the top of the touchscreen displays useful information and provides shortcuts to various features. In addition to the time of day and the current outside temperature, this area displays the following icons:

	Touch to lock/unlock all doors and trunks.
	Touch to display the charging screen and access charge settings on the touchscreen.
	Access information about your Model S. See The Tesla "T" on page 9 .
	Add, configure, or quickly switch driver profiles (including Valet Mode and Easy Entry). See Driver Profiles on page 37 .











	<p>Displays when a notification is in effect. Touch to display information about the notification. To display a list of the most recent notifications, with the most recent listed first, you can also touch Service > Notifications. See Troubleshooting Alerts on page 201.</p>
	<p>Displays when a software update is available (see Software Updates on page 148).</p>
	<p>Displays when Dashcam is ready to be used (you have inserted a supported flash drive into the USB port). Touch to operate Dashcam. When in Park, touch the Dashcam icon and select "Launch Viewer" to watch your saved Dashcam and Sentry Mode clips (see Dashcam on page 74).</p>
	<p>Touch to enable or disable Sentry Mode to actively monitor the vehicle's surroundings (see Sentry Mode on page 141).</p>
	<p>Control or program HomeLink devices (if equipped) (see HomeLink Universal Transceiver on page 145).</p>
	<p>Connected to a Wi-Fi network.</p>
	<p>Connected to cellular network. Touch to connect to Wi-Fi (see Connecting to Wi-Fi on page 147).</p>
	<p>Connect to a Bluetooth device (see Pairing a Bluetooth Phone on page 136).</p>

2. Controls. Touch to control features and customize Model S to suit your preferences (see [Controls on page 117](#)).
3. Media Player (see [Media and Audio on page 133](#)).
4. Touch the app launcher then choose from the following apps:



Touchscreen Overview

	Call. See Phone on page 136.
	Calendar. See Calendar on page 140.
	Camera. Display the area behind Model S. This area also displays automatically whenever you shift into Reverse. See Rear View Camera on page 73.
	Energy. See Getting Maximum Range on page 71.
	Charging. See Charging Instructions on page 155.
	Web. Access the Internet using the web browser). Model S must be in Park.
	Entertainment. Browse the full library of games and access video streaming services, all from your vehicle's touchscreen. To launch, Model S must be in Park. NOTE: Due to vehicle configuration or market region, Entertainment, Arcade, and/or Theater may not be available on your vehicle.
	Toybox. Display Easter Eggs (see Easter Eggs on page 192).

NOTE: Swiping up on the app launcher displays the most recently used app (provided an app is not currently being displayed).

NOTE: Depending on the market region and vehicle options, your vehicle may not be equipped with some features.

5. Climate Controls (see [Climate Controls](#) on page 123).
6. Volume Control (see [Volume Control](#) on page 133).



7. The map displays on the touchscreen at all times (see [Maps and Navigation on page 128](#)).

NOTE: When you touch **Controls**, choose an app, or expand Media Player, the window displays on top of the map. To close the Controls window, touch **Controls** again or touch the **X** in the top corner of the window. To close an app, touch the **X** in the top corner of the window. To close Media Player, drag it all the way down to the bottom of the touchscreen or touch the icon again.

The Tesla "T"

Touch the Tesla "T" at the top center of the touchscreen as a one-touch shortcut to the **Controls > Software** tab, which displays:

- Vehicle name (see [Naming Your Vehicle on page 122](#)).
- Vehicle configuration.
- Odometer.
- Vehicle Identification Number (VIN).
- Version of software currently installed on your Model S.
- Access to release notes associated with the currently-installed software version.
- Access to this owner's manual.
- One-touch access to call Tesla Customer Support and Roadside Assistance (if available in your market region).



Keyless Locking and Unlocking

Locking and unlocking Model S is convenient. Although you must be carrying a valid key, there is no need to use it. Model S has sensors around the driver's door that can recognize the presence of a key within a range of approximately one meter. So, you can keep your key in your pocket or purse and Model S detects it as you approach.

When you walk up to Model S carrying your key, the doors automatically unlock if Passive Entry is on (**Controls > Safety & Security > Passive Entry**). If a door handle is retracted, press it and it extends. If the **Auto-Present Handles** setting is turned on (see [Using Exterior Door Handles on page 11](#)), you do not need to touch the door handle. Instead, door handles extend automatically as you approach Model S. To open the rear trunk, press the switch located under the trunk's exterior handle.

NOTE: Model S must detect your key near the driver's door before the doors or rear trunk unlock.

NOTE: If Passive Entry is off, you must use the key to unlock Model S. See [Using the Key on page 10](#).

NOTE: You can choose whether you want all doors, or just the driver's door, to unlock when you approach Model S carrying your key (see [Door Unlock Mode on page 12](#)).

When carrying your key with you, you can also open the rear trunk without having to use the key. Simply press the switch located under the trunk's exterior handle. Driver Door Unlock Mode (see [Door Unlock Mode on page 12](#)) must be off and the vehicle must detect the key near the driver's door before opening the rear trunk.

Model S also locks automatically. If you enable **Walk Away Door Lock**, Model S locks when you walk away carrying your key with you (see [Walk-Away Door Lock on page 12](#)).

While sitting inside Model S, you can also lock and unlock the vehicle by touching the icon on the touchscreen's status bar or by touching **Controls > Quick Controls**.

NOTE: Depending on date of manufacture and options selected at time of purchase, some Model S vehicles are not equipped with the automatic locking and unlocking feature.

Using the Key

To quickly familiarize yourself with the key, think of the key as a miniature version of Model S, with the Tesla badge representing the front. The key has three buttons that feel like softer areas on the surface.

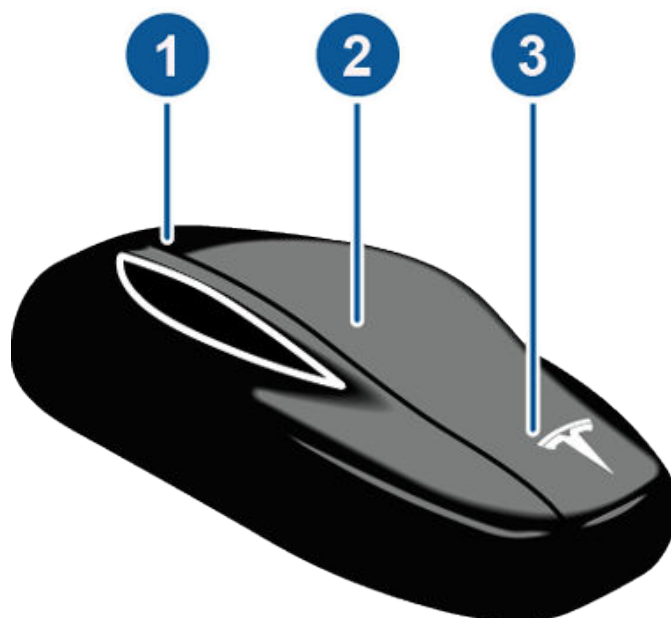

1. Trunk
 - Double-click to open the rear trunk.
 - If equipped with a powered liftgate, double-click to close the rear trunk. You can also single-click to stop the liftgate when it is moving.
 - Hold the button down for one to two seconds to open the charge port door.
2. Lock/Unlock All
 - Single-click to lock doors and trunks (all doors and trunks must be closed). Hazard warning lights flash once and door handles retract. If a door or the rear trunk is open, hazard warning lights flash three times and doors do not lock.
 - Double-click to unlock. Hazard warning lights flash twice and door handles extend. If a door or the rear trunk is open, hazard warning lights flash three times and doors do not lock.
3. Front trunk
 - Double-click to open the front trunk.

You do not need to point the key at Model S, but you must be within operating range (which varies depending on the strength of the key's battery).

If Model S is unable to detect the key, the touchscreen displays a message indicating that a key is not inside. Place the key where Model S can best detect it, which is below the 12V power socket (see [Key Not Inside on page 44](#)).

Radio equipment on a similar frequency can affect the key. If this happens, move the key at least 30 cm away from other electronic devices (phone, laptop, etc). If the key does not work, you may need to change its battery. If the key's battery is discharged, you can open Model S by following the unlocking procedure (see [Unlocking When the Key Doesn't Work on page 13](#)).



For increased security, your key fob may require periodical updates. To update your key fob, go to **Controls > Service > Update Key Fob** and follow the onscreen instructions. Your vehicle must be in Park to update the key fob.

CAUTION: Remember to bring the key with you when you drive. Although you can drive Model S away from its key, you will be unable to power it back on after it powers off.

CAUTION: Protect the key from impact, high temperatures, and damage from liquids. Avoid contact with solvents, waxes and abrasive cleaners.

Replacing the Key Battery

The key's battery lasts for approximately a year with normal use. When the battery is low, a message displays on the instrument panel. Follow these steps to replace it:

NOTE: Tesla recommends replacing the battery in all keys at the same time.

1. With the key placed button-side down on a soft surface, use a small flat-bladed tool or fingernail to release the bottom cover.

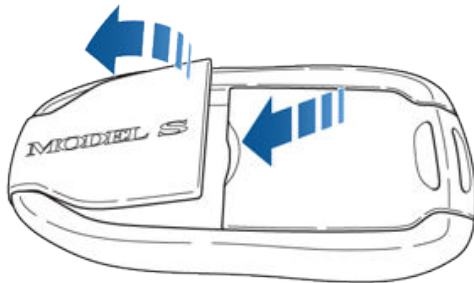

2. Remove the battery by carefully lifting it away from the front retaining clips.

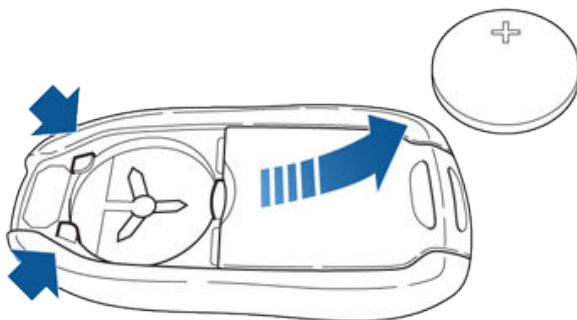

3. Insert the new battery (type CR2032) with the '+' side facing up.

NOTE: Tesla recommends using Panasonic CR2032 batteries. These can be purchased through online retailers, local supermarkets, and drug stores.

NOTE: Wipe the battery clean before fitting and avoid touching the battery's flat surfaces. Finger marks on the flat surfaces of the battery can reduce battery life.

4. Holding the cover at an angle, align the tabs on the widest side of the cover with the corresponding slots on the key, then press the cover firmly onto the key until it snaps into place.
5. Test that the key works by unlocking and locking your vehicle.

Getting More Keys

If you lose a key or require an additional one, contact Tesla. Model S can recognize up to three keys.

When ordering a new key for Model S, take all available keys with you for reprogramming.

Using Exterior Door Handles

A light press on a door handle extends it, provided Model S detects a valid key nearby and Passive Entry is on (**Controls > Safety & Security > Passive Entry**).

You can set the door handles to extend automatically whenever you approach the driver's side carrying the key. On the touchscreen, touch **Controls > Vehicle > Auto-Present Handles**.

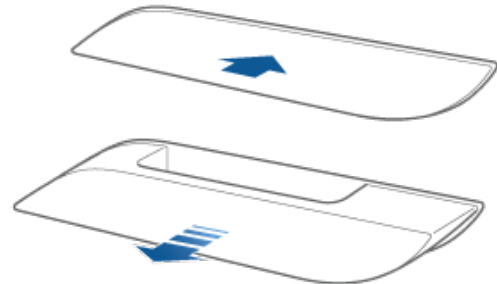

Insert your hand into the handle and pull to open the door.

Door handles retract if you do not use them within one minute after they extend. Just press a handle to extend it again. Door handles also retract a minute after the last door closes, when Model S begins moving, and when you lock Model S.

NOTE: To preserve battery life, Model S is designed to temporarily disable the **Auto-Present Handles** feature when:

- The key has been out of range for more than 48 hours.



Keys and Doors

- The key remains within range for five minutes after all doors have been closed.

In these cases, extend door handles by touching one of them, or by pressing the unlock button on the key. There is no need to reset the setting. The next time you approach Model S, provided the above conditions do not apply, handles automatically extend.



Whenever a door is open, the Door Open indicator displays on the instrument panel. Also, the image of the Model S on the touchscreen's **Controls > Quick Controls** window also provides a visual representation of an open door or trunk.

Opening Doors from the Interior

To open a door, pull the interior door handle toward you.

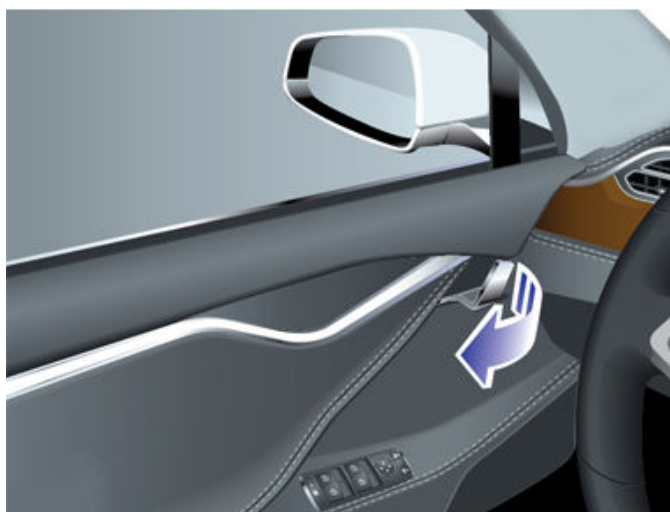

NOTE: To prevent children from opening rear doors using the interior handles, use the touchscreen, **Controls > Vehicle > Child-Protection Lock**, to turn on the child-protection locks (see [Child-Protection Lock on page 12](#)).

Interior Locking and Unlocking

From inside Model S, you can use the touchscreen to lock or unlock doors and trunks, provided a valid key is inside the vehicle. Touch the lock icon on the touchscreen's status bar.

When you stop Model S and engage the Park gear, you can choose whether you want doors to unlock or remain locked. To do so, touch **Controls > Vehicle > Unlock on Park**. When enabled, doors automatically unlock when you engage the Park gear.

You can also unlock doors and present handles by pressing the Park button on the end of the gear selector a second time (for example, after pressing it one time to engage the Park gear).

NOTE: If a door or trunk is still open when you lock Model S, it locks when you close it.

Door Unlock Mode

You can choose to unlock only the driver's door when you approach your vehicle carrying your key or when you shift into Park. To do so, touch **Controls > Vehicle > Driver Door Unlock Mode**.

Child-Protection Lock

Model S has child-protection locks on the rear doors and liftgate to prevent them from being opened using interior handles. Use the touchscreen to turn child-protection locks on or off. Touch **Controls > Vehicle > Child-Protection Lock**.

NOTE: It is recommended that you turn child-protection locks on whenever children are seated in the rear seats.

Drive Away Locking

Model S automatically locks all doors (including the trunks) whenever your driving speed exceeds 8 km/h.

Walk-Away Door Lock

Doors and trunks automatically lock whenever you walk away carrying the key or if the key is otherwise not detected by your vehicle (not present, dead battery, etc.).

To turn this feature on or off, touch **Controls > Vehicle > Walk-Away Door Lock**.

Check the **Exclude Home** checkbox to prevent doors from locking when you walk away carrying the key when Model S is parked at the location you have designated as Home. For details on how to designate a location as Home, see [Recent, Favorite, Home and Work Destinations on page 131](#).

NOTE: If Model S detects an authenticated key for five minutes after you exit the vehicle and close all doors, Walk-Away Door Lock disables and doors do not lock when you leave with the key. You will need to manually lock Model S until after your next drive.

NOTE: If all doors are closed and you use the key to unlock Model S, walk away locking is temporarily suspended for one minute. If you open a door within this minute, it does not re-lock until after all the doors are closed and you have walked away with the key.



NOTE: If you unlock Model S using the mobile app, it automatically locks after a short period of time if all doors remain closed. If parked in an area without cellular service (such as an indoor parking garage), ensure that you have a functional key fob available to unlock Model S.

Unlocking When the Key Doesn't Work

If Model S does not unlock when you walk up to it, or when you double-click the unlock button on the top of your key, the key's battery may be dead. Even if this is the case, you can still use the key to unlock and drive Model S.

NOTE: Although you can still use your key, you should consider using the mobile app to remotely unlock and start the vehicle. Then, replace your key's battery when convenient.

To unlock Model S (and disable the security alarm) using the key, first position the key near the base of the passenger side windshield wiper. Then press the front door handle on the right side of the vehicle. If Model S doesn't unlock, try adjusting the position of the key and try again. The key must be in the correct position for the vehicle to unlock.

NOTE: The following illustration assumes a left hand drive (LHD) vehicle. On a right hand drive (RHD) vehicle, the locations are mirrored.



To drive Model S after gaining access to the cabin, place the bottom of the key against the center console, immediately below the 12V power outlet, then press and hold the brake pedal to start Model S.

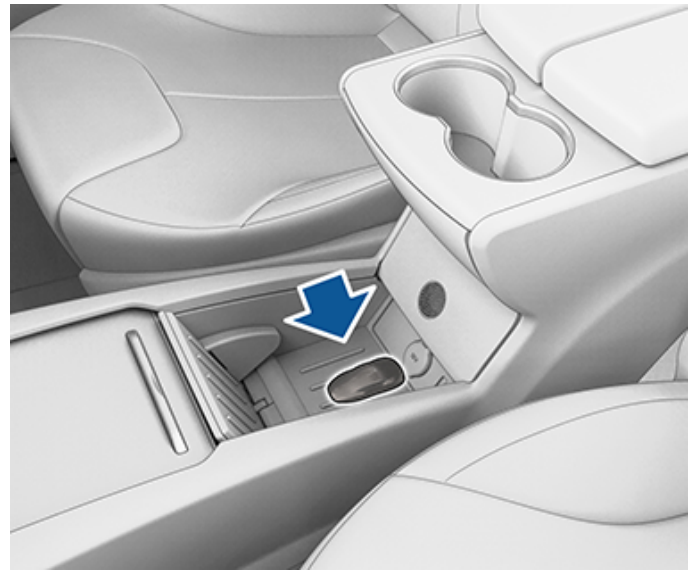

NOTE: Unlocking Model S using this method disables walk away locking. You must manually re-enable walk away locking after replacing the key's battery.

Opening Interior Doors with No Power

If Model S has no electrical power, the front doors open as usual using the interior door handles. To open the rear doors, fold back the edge of the carpet below the rear seats to expose the mechanical release cable. Pull the mechanical release cable toward the center of the vehicle.

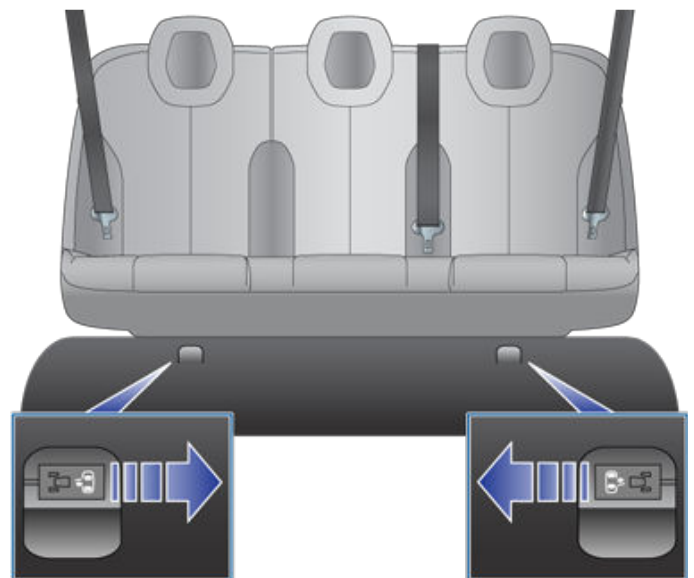



Opening and Closing

Press down on a switch to lower the associated window. Window switches operate at two levels:

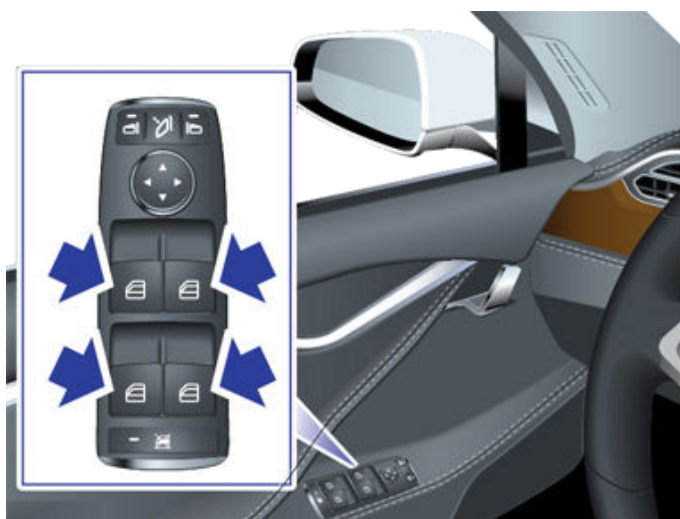
- To lower a window fully, press the switch all the way down and immediately release.
- To lower a window partially, press the switch gently and release when the window is where you want it.



 **WARNING:** To ensure safety, it is recommended that you lock the rear window switches whenever children are seated in the rear seats.

 **WARNING:** Never leave children unattended in Model S.

Similarly, pull a switch to raise the associated window:

- To raise a window fully, pull the switch all the way up and immediately release.
- To raise a window partially, pull the switch gently and release when the window is where you want it.

NOTE: See [Cold Weather Best Practices on page 77](#) for information on preparing windows for cold weather.

 **CAUTION:** When exiting the vehicle, be careful not to unintentionally press the window switches, as they may lower the windows on the driver or other doors.

 **CAUTION:** Closing the door while the window is fully raised (for example, if manually raised) can damage the windows or the vehicle. Ensure the window is slightly lowered before closing the door.

 **WARNING:** Before closing a window, it is the driver's responsibility to ensure that all occupants, especially children, do not have any body parts extended through the window's opening. Failure to do so can cause serious injury.

Locking Rear Windows

To prevent passengers from using the rear window switches, press the rear window lock switch. The switch light turns on. To unlock rear windows, press the switch again.

Opening

To open the rear trunk, ensure the vehicle is in Park, then do one of the following:

- Touch the associated **OPEN** button on the touchscreen (**Controls** > **Quick Controls**).
- Double-click the rear trunk button on the key.
- Touch the rear trunk button on the mobile app.
- With Model S unlocked, press the switch located under the rear trunk's exterior handle.

NOTE: If **Passive Entry** is off, you must use the key to unlock Model S before you can use the switch to manually open the rear trunk. See [Using the Key on page 10](#).

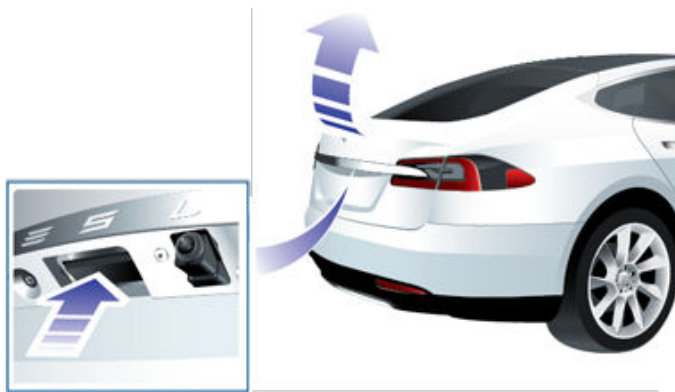

When a door or the rear trunk powered liftgate is open, the instrument panel displays the Door Open indicator light. The image of your Model S on the touchscreen also displays the open trunk.

To stop a powered liftgate while it is moving, single-click the rear trunk button on the key fob. Then, when you double-click the rear trunk button, it moves again, but in the opposite direction (provided it was not almost entirely open or closed when you stopped it). For example, if you single-click to stop the powered liftgate while it is opening, when you double-click, it closes.

NOTE: In emergency situations, you can override an Open or Close command by grabbing hold of the powered liftgate to stop it in place.

To open the rear trunk from inside Model S in the unlikely situation that Model S has no power, see [Interior Emergency Trunk Release on page 16](#).

WARNING: Before opening or closing the powered liftgate, it is important to check that the area around the liftgate is free of obstacles (people and objects). You must proactively monitor the liftgate to ensure that it does not come into contact with a person or object. Failure to do so may result in damage or serious injury.

Load Limits

Secure all cargo before moving Model S, and place heavy cargo in the lower trunk compartment.

CAUTION: To avoid damage, never load more than 175 lbs (80 kg) on the rear load floor (above the lower trunk compartment), or more than 285 lbs (130 kg) in the large lower trunk compartment. Doing so can cause damage.

Closing

If Model S is not equipped with a powered liftgate, close the rear trunk by pulling down on the liftgate and pushing firmly until it is fully closed.

To close the powered liftgate, do one of the following:

- Touch the associated **CLOSE** button on the touchscreen (**Controls** > **Quick Controls**).
- Double-click the rear trunk button on the key fob.
- Press the switch located on the underside of the liftgate (see [Adjusting Liftgate Opening Height on page 15](#)).

If the powered liftgate senses an obstruction when closing, it stops moving and sounds two chimes. Remove the obstruction and try closing it again.

Adjusting Liftgate Opening Height

If Model S is equipped with a powered liftgate, you can adjust its opening height to make it easier to reach or to avoid low-hanging ceilings or objects (for example, a garage door or light):

1. Open the trunk, then manually lower or raise the liftgate to the desired opening height.
2. Press and hold the button on the underside of the liftgate for three seconds until you hear a confirmation chime.



Rear Trunk



3. Confirm that you have set it to the desired height by closing the powered liftgate, then reopening it.

Interior Release

To open the rear trunk from inside a Model S equipped with the Tesla Built-In Rear Facing Child Seats, press the interior release switch located inside the rear trunk and push the liftgate up. If Model S is locked and is equipped with a power liftgate, the first press unlocks the rear trunk and the second press opens it.

NOTE: If Model S is not equipped with the Tesla Rear Facing Child Seats, the switch may appear to exist, but it will be inactive and pressing it does not release the liftgate.



If Model S is equipped with the power liftgate, you do not need to push it up. When you press the release switch, it opens, and when you pull the switch, it closes.

NOTE: The interior release switch is disabled if child-protection locks are turned on (see [Child-Protection Lock](#) on page 12), or if Model S is moving.

Accessing the Cargo Area

To access the cargo area inside the rear trunk, pull up the strap at the rear of the cargo cover. You can then fold the cargo cover forward or remove it from Model S.

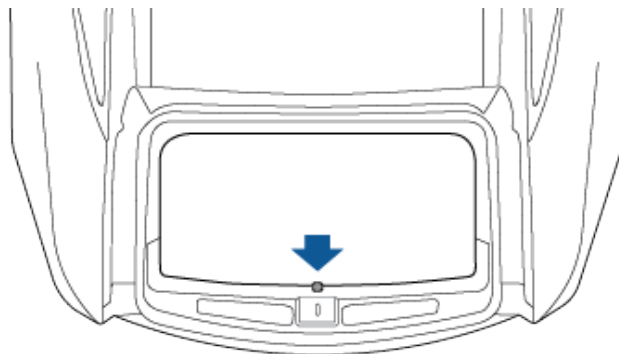

CAUTION: Never load more than 175 lbs (80 kg) on the rear load floor (above the lower trunk compartment) or more than 285 lbs (130 kg) in the lower trunk compartment. Doing so can cause damage.

Interior Emergency Trunk Release

An illuminated mechanical release located inside the rear trunk allows you to open the rear trunk from the inside if Model S has no electrical power. This mechanical release also allows a person locked inside to get out.

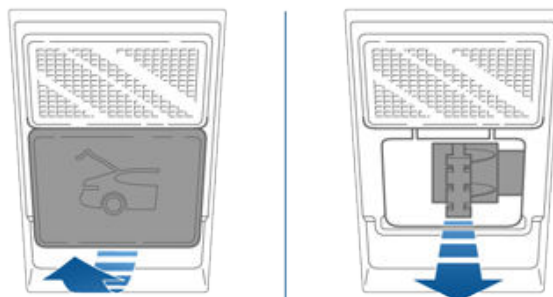

1. Remove the cover by pulling its lower edge very firmly toward you.
2. Pull the cable to release the latch.
3. Push the rear trunk open.

NOTE: The button glows for several hours after a brief exposure to ambient light.



WARNING: Do not allow children to play inside the trunk or become locked inside. An unrestrained child could suffer serious injury or death in a crash. A child could suffer heat exhaustion if trapped in the vehicle, especially without climate control on.

Opening

To open the front trunk:

1. Ensure that the area around the hood is free of obstacles.
2. Touch the associated **OPEN** button on the touchscreen (**Controls** > **Quick Controls**), double-click the front trunk button on the key, or touch the front trunk button on the mobile app.
3. Pull the hood up.

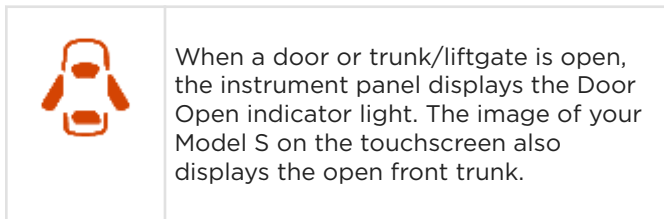
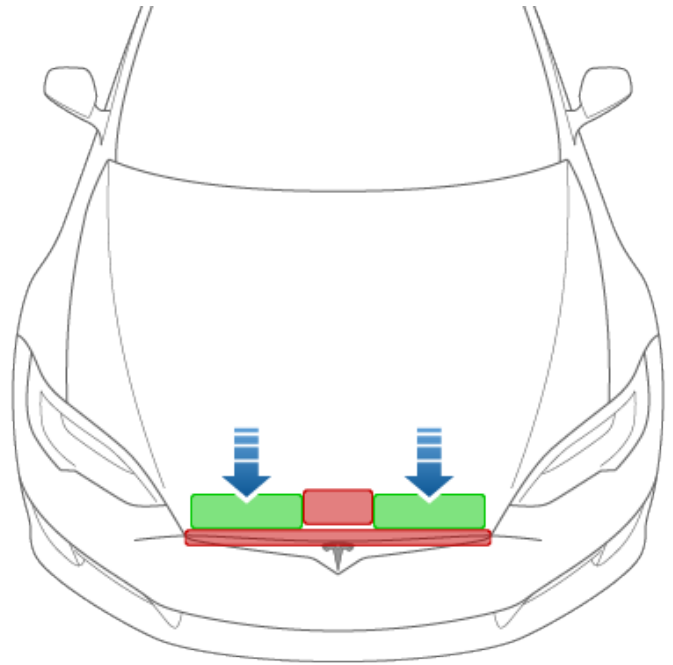
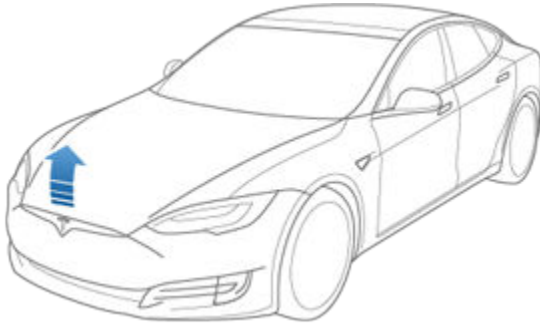

WARNING: Before opening or closing the hood, it is important to check that the area around the hood is free of obstacles (people and objects). Failure to do so may result in damage or serious injury.

NOTE: The front trunk locks whenever closed and you lock Model S using either the touchscreen or externally using the key or mobile app, you leave Model S carrying your key (if [Walk-Away Door Lock](#) on page 12 is turned on), or when Valet mode is active (see [Valet Mode](#) on page 38).

Closing

The Model S hood is not heavy enough to latch under its own weight and applying pressure on the front edge or center of the hood can cause damage.

To properly close the hood:

1. Lower the hood until the striker touches the latches.
2. Place both hands on the front of the hood in the areas shown (in green), then press down firmly to engage the latches.
3. Carefully try to lift the front edge of the hood to ensure that it is fully closed.

CAUTION: To prevent damage:

- Apply pressure only to the green areas shown. Applying pressure to the red areas can cause damage.
- Do not close the hood with one hand. Doing so applies concentrated force in one area and can result in a dent or crease.
- Do not apply pressure to the front edge of the hood. Doing so can crease the edge.
- Do not slam or drop the hood.

WARNING: Before driving, you must ensure that the hood is securely latched in the fully closed position by carefully trying to lift the front edge of the hood upward and confirming there is no movement.

Interior Emergency Release

An illuminated interior release button inside the front trunk allows a person locked inside to get out.

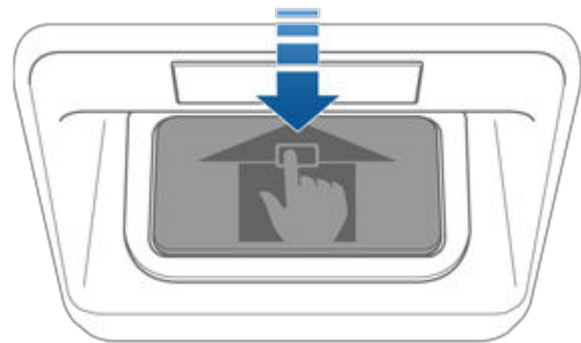





Front Trunk

Press the interior release button to open the front trunk, then push up on the hood.

NOTE: The interior release button glows following a brief exposure to ambient light.

 **WARNING:** People should never climb inside the front trunk. Never shut the front trunk when a person is inside.

 **WARNING:** Care should be taken to ensure that objects inside the front trunk do not bump against the release button, causing the trunk to accidentally open.



Glovebox

To open the glovebox, press the switch located on the side of the touchscreen. The glovebox locks whenever Model S is locked externally, using the key or walk-away locking. It also locks when Model S is in Valet mode (see [Valet Mode on page 38](#)). It does not lock when you lock Model S using the lock icon on the touchscreen's status bar.

For additional glovebox security, touch **Controls** > **Safety & Security** > **Glovebox PIN** to set a 4-digit PIN (see [Glovebox PIN on page 141](#)).

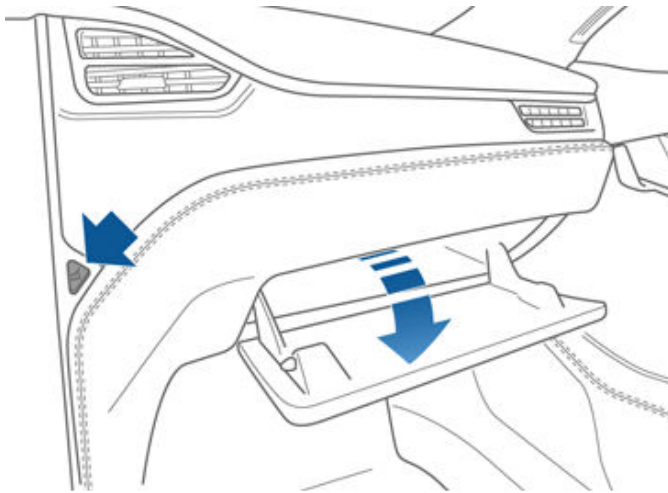

NOTE: If you leave the glovebox open, its light eventually turns off.

⚠ WARNING: When driving, keep the glovebox closed to prevent injury to a passenger if a collision or sudden stop occurs.

USB Ports

Your Model S has two USB ports located on the front of the center console that you can use to connect USB devices. To play audio files stored on a USB drive connected to these ports, see [Playing Media from Devices on page 134](#). You can also use these ports to charge USB devices.

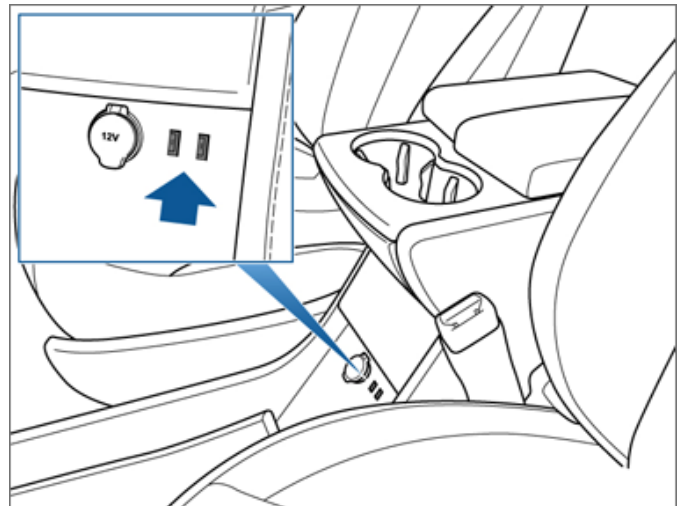

NOTE: Do not connect multiple devices using a USB hub. This can prevent connected devices from charging or from being recognized by the Media Player.

NOTE: Power is available whenever the vehicle is considered "awake" The vehicle may be awake for many reasons. For example, when using features such as Summon, or when features such as Smart Preconditioning, Cabin Overheat Protection, Keep Climate On, Dog Mode, Sentry Mode, etc. are enabled. The vehicle is also awake whenever the 12V battery is being charged or is in use, during HV charging, when the vehicle is communicating with the mobile app, etc. Leaving an accessory plugged in does not deplete the 12V battery.

Wireless Phone Charger

If equipped, the Model S wireless phone charger provides up to 7.5W to charge a Qi-enabled smartphone. Simply open the center console and place your smartphone in the charger, located on the back of the bin cover. The wireless phone charger uses a front USB port. Your device may feel warm while charging, but this is a normal effect of inductive charging.

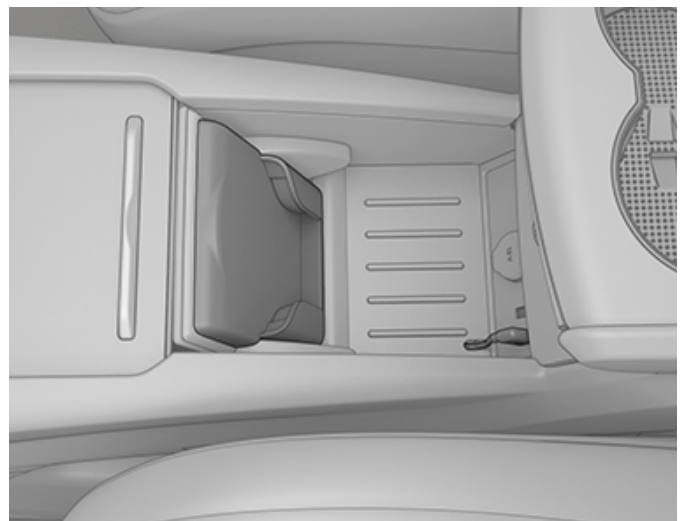



Interior Storage and Electronics

Model S will charge your smartphone only when the vehicle is powered on (the touchscreen is on and you are in the vehicle). Your smartphone will not charge after exiting the vehicle. Model S will also not charge if the vehicle's Battery is discharged.

NOTE: Ensure your smartphone supports inductive charging.

NOTE: The wireless phone charger may not work if your smartphone case is too large or is made of metal. Try removing the smartphone from its case before placing in the charger.

12V Power Socket

Your Model S has a power socket located on the front of the center console. Power is available whenever the instrument panel and touchscreen are on.

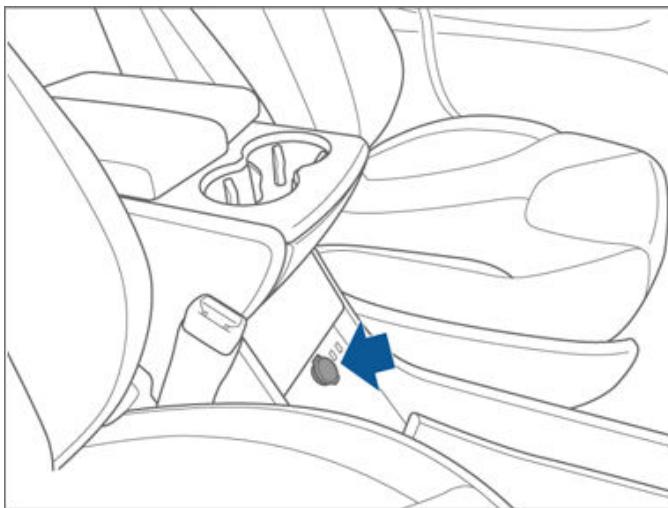

The 12V power socket is suitable for accessories requiring up to 11A continuous draw (15A peak) or a maximum of 150 continuous watts (180 watts peak).

NOTE: Power is available whenever the vehicle is considered "awake." The vehicle may be awake for many reasons. For example, when using features such as Summon, or when features such as Smart Preconditioning, Cabin Overheat Protection, Keep Climate On, Dog Mode, etc. are enabled. The vehicle is also awake whenever the 12V battery is being charged or is in use, during HV charging, when the vehicle is communicating with the mobile app, etc. Leaving an accessory plugged in does not deplete the 12V battery.

NOTE: In situations where Model S is unable to detect the key (low battery, interference, etc.), place it immediately below the 12V power socket where Model S can best detect it.



WARNING: The power socket and an accessory's connector can become hot.



Cup Holders

To expose a front cup holder, slide back the armrest.

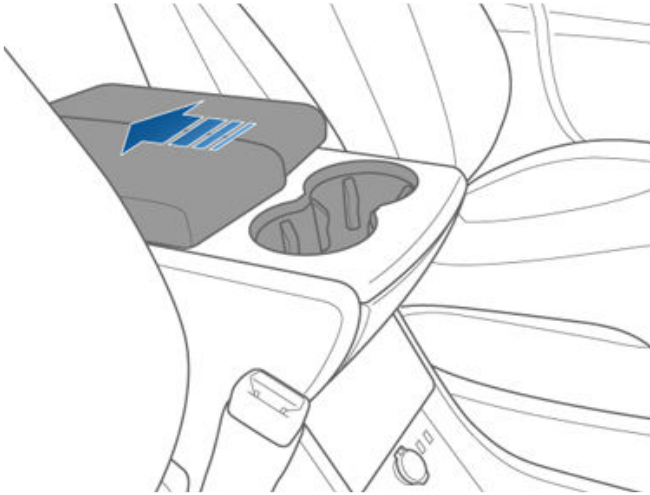

To expose rear cup holders (if equipped), press and release the cup holder face plate located at the back of the center console.

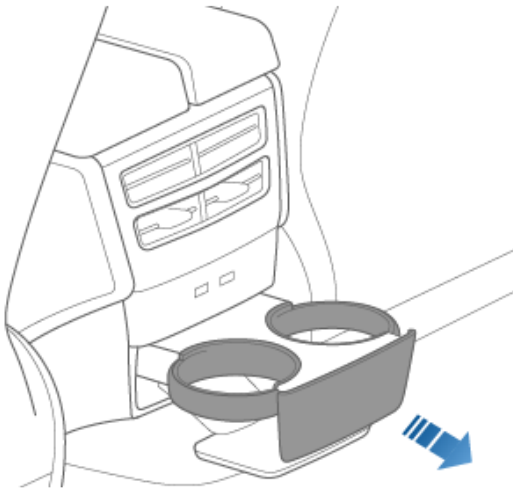

Opening and Closing

If your Model S is equipped with a sunroof, you can vent and close the sunroof remotely using the mobile app or you can adjust the position of the sunroof by controlling it from the menu on your right scroll wheel.





For full control of the sunroof, touch **Controls** > **Quick Controls** on the touchscreen. Drag, or tap on, the image of the sunroof or touch the buttons next to the image of your vehicle. The sunroof moves to the selected position. To stop the sunroof from moving at any time, touch the image of the sunroof.



- **OPEN:** touch once to open the sunroof to its comfort position (75% open). Touch twice to open the sunroof fully.
- **VENT:** touch to open the sunroof slightly.
- **CLOSE:** touch to fully close the sunroof.

NOTE: If the sunroof detects any obstruction, it does not close. If, after removing the obstruction, it still does not close, touch and hold **CLOSE** to override the sunroof's anti-trap mechanism.

NOTE: If you find wind noise (which varies depending on driving speed) excessive, even with the sunroof in the comfort position, open a window slightly.

-  **CAUTION:** Remove snow and ice before opening the sunroof. Opening a sunroof covered in snow and ice can cause damage.
-  **WARNING:** Do not allow occupants to extend any part of their body through the sunroof. Doing so can cause serious injury from flying debris, tree branches, or other obstructions.
-  **WARNING:** Before closing the sunroof, ensure that occupants, especially children, do not have any body part extended through the sunroof opening. Failure to do so can cause serious injury.
-  **WARNING:** Do not carry an object that protrudes through the sunroof. Doing so can damage the sunroof's seals and anti-trap mechanism, and can cause injury to occupants.



Correct Driving Position

The seat, head support, seat belt and airbags work together to maximize your safety. Using these correctly ensures greater protection.

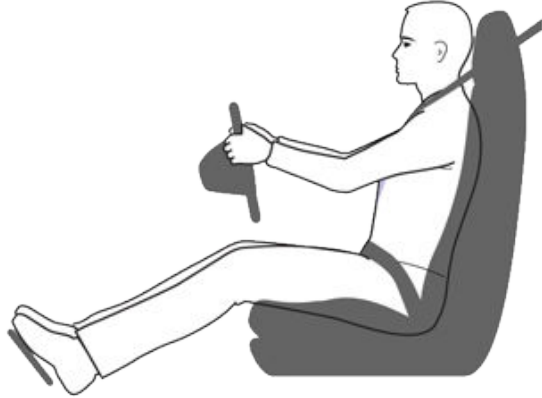

Position the seat so you can wear the seat belt correctly, while being as far away from the front airbag as possible:

1. Sit upright with both feet on the floor and the seat back reclined no more than 30 degrees.
2. Make sure you can easily reach the pedals and that your arms are slightly bent when holding the steering wheel. Your chest should be at least 25 cm from the center of the airbag cover.
3. Place the shoulder section of the seat belt mid-way between your neck and your shoulder. Fit the lap section of the belt tightly across your hips, not across your stomach.

Model S seats include integrated head supports that cannot be adjusted or removed.

Adjusting the Front Seats

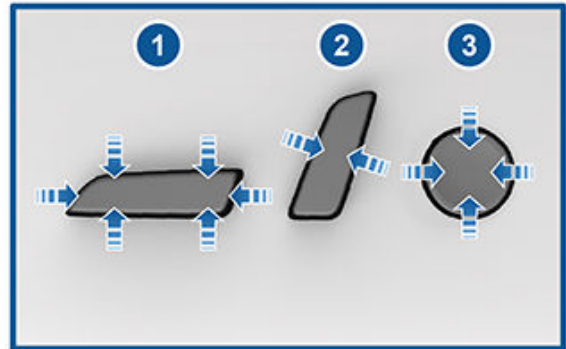

1. Move seat forward/backward and adjust the seat's height and tilt angle up/down.
2. Adjust backrest.
3. Adjust lumbar support.

⚠ WARNING: Before adjusting a front seat, check that the area around the seat is free of obstacles (people and objects).

⚠ WARNING: Do not adjust seats while driving. Doing so increases the risk of a collision.



Front and Rear Seats

⚠ WARNING: Riding in a moving vehicle with the seat back reclined can result in serious injuries in a collision, as you could slide under the lap belt or be propelled into the seat belt. Ensure your seat back is reclined no more than 30 degrees when the vehicle is moving.

Folding Rear Seats

Model S has a split rear seat that can fold forward.

NOTE: If Model S is equipped with the optional executive rear seats, these seats do not fold forward.

NOTE: Driving with the rear seats folded forward might result in increased perceivable noise and/or vibration coming from the rear of the vehicle (trunk, suspension, etc.).

Before folding, remove items from the seats and the rear footwell. To allow the rear seat backs to fold completely flat, you may need to move the front seats forward.

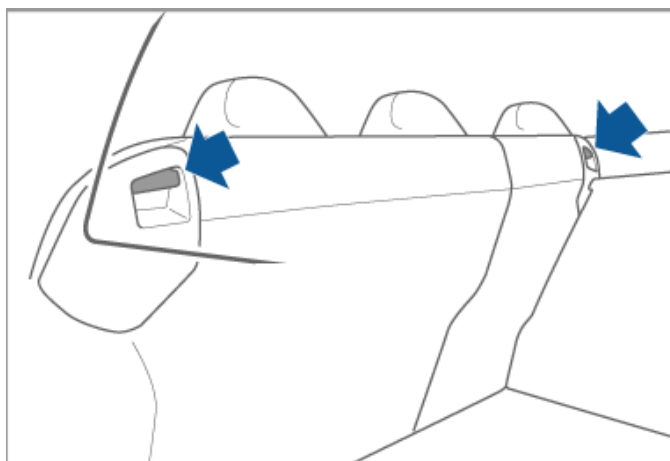

To fold a rear seat, pull the corresponding lever and fold the seat forward.

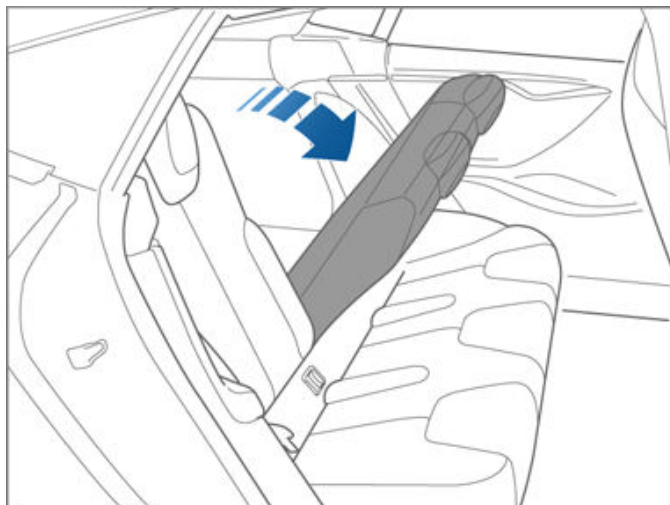

Raising Rear Seats

Before raising a rear seat, make sure that the seat belts are not trapped behind the backrest.

Pull the seat back upward until it locks into place.

To confirm that the seat back is locked in the upright position, try pulling it forward.

⚠ WARNING: Always ensure the seat backs are locked in their upright position by pushing it forward or rearward. Failure to do so increases the risk of injury.

Seat Heaters

The front seats contain heating pads that operate at three levels from 3 (highest) to 1 (lowest). To operate the seat heaters, see [Climate Controls on page 123](#).

If Model S is equipped with the cold weather package, you can also control seat heaters in all rear seating positions, as well as heated wipers and washer nozzles by touching the climate controls on the touchscreen (see [Climate Controls on page 123](#)).

⚠ WARNING: To avoid burns resulting from prolonged use, individuals who have peripheral neuropathy, or whose capacity to feel pain is limited because of diabetes, age, neurological injury, or some other condition, should exercise caution when using the climate control system and seat heaters.

Seat Covers

⚠ WARNING: Do not use seat covers in Model S. Doing so could restrict deployment of the seat-mounted side air bags if a collision occurs. Also, if the vehicle is equipped with an occupant detection system that is used to determine the status of the passenger front airbag, seat covers may interfere with this system.

Wearing Seat Belts

Using seat belts and child safety seats is the most effective way to protect occupants if a collision occurs. Therefore, wearing a seat belt is required by law in most jurisdictions.

Both the driver and passenger seats are equipped with three-point inertia reel seat belts. Inertia reel belts are automatically tensioned to allow occupants to move comfortably during normal driving conditions.

The seat belt reel automatically locks to prevent movement of occupants if Model S experiences a force associated with hard acceleration, braking, cornering, or an impact in a collision.

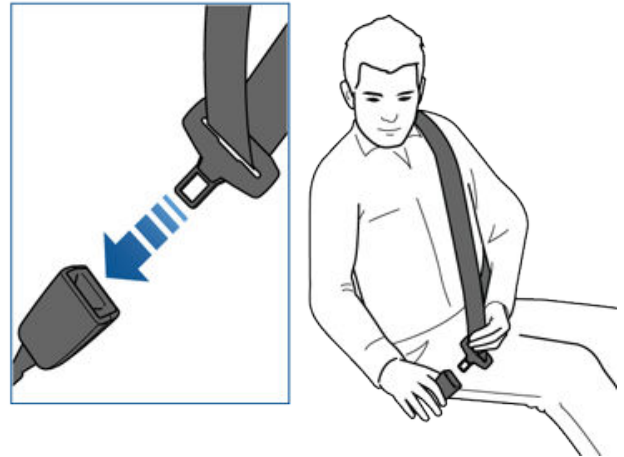

Seat Belt Reminders



The seat belt reminder on the instrument panel alerts you if a seat belt for an occupied driver or passenger seat is unbuckled. If the belt remains unbuckled, the reminder flashes and an intermittent chime sounds. If all occupants are buckled up and the reminder stays on, re-buckle seat belts to ensure they are correctly latched. Also remove any heavy objects (such as a briefcase) from an unoccupied seat. If the reminder light continues to stay on, contact Tesla.

WARNING: Seat belts must be worn by passengers in all seating positions.

To Fasten a Belt

1. Ensure correct positioning of the seat (see [Correct Driving Position on page 23](#)).
2. Draw the belt out smoothly, ensuring the belt lays flat across the pelvis, chest and mid-point of your collar bone, between the neck and shoulder.
3. Insert the latch plate into the buckle and press together until you hear a click indicating it is locked in place.

4. Pull the belt to check that it is securely fastened.
5. Pull the diagonal part of the belt toward the reel to remove excess slack.

To Release a Belt

Hold the belt near the buckle to prevent the belt from retracting too quickly, then press the button on the buckle. The belt retracts automatically. Ensure there is no obstruction that prevents the belt from fully retracting. The belt should not hang loose. If a seat belt does not fully retract, contact Tesla.

Wearing Seat Belts When Pregnant

Do not put the lap or shoulder sections of the seat belt over the abdominal area. Wear the lap section of the belt as low as possible across the hips, not the waist. Position the shoulder portion of the belt between the breasts and to the side of the abdomen. Consult your doctor for specific guidance.





Seat Belts

WARNING: Never place anything between you and the seat belt to cushion the impact in the event of a collision.

Seat Belt Pre-tensioners

The front seat belts are equipped with pre-tensioners that work in conjunction with the airbags in a severe frontal collision. The pre-tensioners automatically retract both the seat belt anchor and the seat belt webbing, reducing slack in both the lap and diagonal portions of the belts, resulting in reduced forward movement of the occupant.

The outboard seats are equipped with shoulder pre-tensioners to retract the seat belt webbing to reduce forward movement of the occupant.

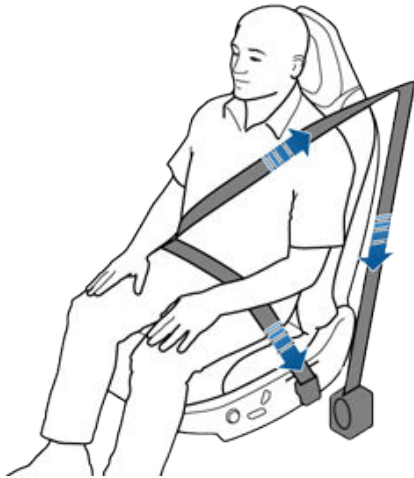

If the pre-tensioners and airbags did not activate in an impact, this does not mean they malfunctioned. It usually means that the strength or type of force needed to activate them was not present.

WARNING: Once the seat belt pre-tensioners have been activated, they must be replaced. After any collision, have the airbags, seat belt pre-tensioners and any associated components checked and, if necessary, replaced.

Testing Seat Belts

To confirm that seat belts are operating correctly, perform these three simple checks on each seat belt.

1. With the seat belt fastened, give the webbing nearest the buckle a quick pull. The buckle should remain securely locked.
2. With the belt unfastened, unreel the webbing to its limit. Check that unreeling is free from snags, and visually check the webbing for wear. Allow the webbing to retract, checking that retraction is smooth and complete.

3. With the webbing half unreeled, hold the tongue plate and pull forward quickly. The mechanism should lock automatically and prevent further unreeling.

If a seat belt fails any of these tests, contact Tesla immediately.

For information about cleaning seat belts, see [Seat Belts on page 168](#).

Seat Belt Warnings

- WARNING:** Seat belts should be worn by all occupants at all times, even if driving for a very short distance. Failure to do so increases the risk of injury or death if a collision occurs.
- WARNING:** Secure small children in a suitable child safety seat as described in the Child Safety Seat topic. Always follow the child safety seat manufacturer's instructions when installing.
- WARNING:** Ensure that all seat belts are worn correctly. An improperly worn seat belt increases the risk of injury or death if a collision occurs.
- WARNING:** Do not wear seat belts over hard, fragile or sharp items in clothing, such as pens, keys, eyeglasses, etc. The pressure from the seat belt on such items can cause injury.
- WARNING:** Seat belts should not be worn with any part of the strap twisted.
- WARNING:** Each seat belt assembly must be used by one occupant only. It is dangerous to put a seat belt around a child being carried on an occupant's lap.
- WARNING:** Seat belts that have been worn in a collision must be inspected or replaced by Tesla, even if damage to the assembly is not obvious.
- WARNING:** Seat belts that show signs of wear (such as fraying), or have been cut or damaged in any way, must be replaced by Tesla.
- WARNING:** Avoid contaminating a seat belt's components with any chemicals, liquids, grit, dirt or cleaning products. If a seat belt fails to retract or latch into the buckle, it must be replaced immediately. Contact Tesla.
- WARNING:** Do not make modifications or additions that can prevent a seat belt mechanism from taking up slack, or that can prevent a seat belt from being adjusted to remove slack. A slack belt greatly reduces occupant protection.
- WARNING:** Do not make modifications that can interfere with the operation of a seat belt, or that can cause a seat belt to become inoperable.
- WARNING:** When seat belts are not in use, they should be fully retracted and not hanging loose. If a seat belt does not fully retract, contact Tesla.



Guidelines for Seating Children

WARNING: Never seat an infant or a child on the front passenger seat.

Your Model S seat belts are designed for adults and larger children. You must restrain infants and small children in the rear seats only, and you must use a suitable child safety seat appropriate for the child's age, weight, and size.

Refer to the following label fitted to the sun visors.

NOTE: The image shown below is representative only and may not be identical to the label in your vehicle.



The status of the passenger front airbag displays in the top corner of the touchscreen:

	<p>The Passenger Airbag On indicator displays in the top corner of the touchscreen to indicate that the passenger front airbag may inflate if a collision occurs.</p>
--	---

For details on how the passenger front airbag is controlled, see [Airbags on page 34](#).

WARNING: Do not use **Easy Entry** (as described in [Driver Profiles on page 37](#)) to automatically move the driver's seat to the full rearward position if a child safety seat is installed on a rear seat behind the driver's seat. With reduced clearance, the movement of the seat may impact a child's legs, cause injury, or dislodge the seat.

Choosing a Child Safety Seat

Choose a child restraint system that meets AS/NZS 1754. For more information about child seats, go to www.childcarseats.com.au. Child restraint systems purchased outside of Australia may not meet these standards.

⚠ WARNING: To ensure safety of infants and children, it is advisable to purchase a new child restraint system. However, if a used child restraint system is necessary, heed these warnings:

- Do not use a child restraint system that is more than 10 years old.
- Ensure the child restraint system meets AS/NZS 1754. This information should be visible on a label affixed to the child restraint system.
- Confirm that the child restraint system was not being used in a vehicle that was involved in a collision.
- Ensure that all components (buckles, etc.) of the child restraint system operate smoothly and there are no signs of wear or damage (splits, cracks etc.).
- Ensure the harnesses on the child restraint system are not frayed, worn or damaged
- Ensure the child restraint system has an instruction manual.

Refer to the following tables for guidelines on the type of seat belt installed and ISOFIX installed child restraint you should use based on the weight of the child.

⚠ WARNING: It is the driver's responsibility to comply with all current regulations in regions where Model S is driven. Some regions prohibit seating an infant or child in the front passenger seat.

Seat Belt Installed Child Restraints

Mass Group		Front Passenger	Rear Outboard	Rear Center ^C
Group 0	up to 10 kg	X	U	U
Group 0+	up to 13 kg	L ^A	U	U
Group I	9 - 18 kg	UF ^B	U, UF	U, UF
Group II	15 - 25 kg	UF ^B	U, UF	U, UF
Group III	22 - 36 kg	UF ^B	U, UF	U, UF

U: Universal rear facing child restraint.

UF: Universal forward facing child restraint.

L: Suitable for these particular child restraints - Maxi-Cosi Cabrio/Cabriofix E4 04443517 or Takata Mini E4 04443717.

X: Seating position is not suitable for children in this mass group.

^ASeat must be placed in rearmost lowest position.

^BSeat must be placed in rearmost highest position.

^CIf Model S is equipped with the optional executive rear seats, a rear center seating position is not available.

NOTE: Attach booster seats using seat belts only (do not use ISOFIX).



ISOFIX Installed Child Restraints

NOTE: ISOFIX are international standards for attachment points for child safety seats in passenger vehicles.

Mass Group		Size Class	Fixture	Rear Outboard ISOFIX Position
Group 0	up to 10 kg	E	R1 NOTE: Attach booster seats using seat belts only (do not use ISOFIX).	IL
Group 0+	up to 13 kg	E	R1	IL ^{A, C}
		D	R2	IL ^{A, C}
		C	R3	IL ^{A, C}
Group I	9 - 18 kg	D	R2	IL ^B
		C	R3	IL ^B
		B	F2	IUF, IL ^{B, D}
		B1	F2X	IUF, IL ^{B, D}
		A	F3	IUF, IL ^{B, D}

IL: Suitable for any semi-universal child restraint (any rear or forward facing restraint with support leg).

IUF: Suitable for any universal child restraint (forward facing with tether).

^ARecommendation: Takata Mini E4 04443717.

^BRecommendation: Takata Midi E4 04444204.

^CRecommendation: Maxi-cosi Cabriofix/Easyfix E4 04443517.

^DRecommendation: Maxi-cosi Pearl/Familyfix E4 043908.

⚠ WARNING: Do not use ISOFIX anchors with child restraint system or booster seats that have an integral safety belt where the combined weight of the child plus the child restraint system exceeds 33 kg.

Seating Larger Children

If a child is too large to fit into a child restraint system, but too small to be safely secured using the vehicle's seat belts, use a booster seat appropriate for the child's age and size. When using and installing a booster seat, carefully follow the instructions provided by the manufacturer.

Two Installation Methods

NOTE: Always install child restraint systems by following the instructions provided by the manufacturer of the child restraint system.

Among many other variants, there are two general types of child restraint systems based on how they are secured in the seat:

- Belt-based - secured using the vehicle's seat belts (see [Installing Seat Belt Retained Child Seats on page 30](#)).
- ISOFIX - secured to anchor bars built into the vehicle's seats (see [Installing ISOFIX Child Seats on page 30](#)).

Some child restraint systems can be installed using either method. Refer to the instructions provided by the manufacturer of the child restraint system to determine which installation method to use and for detailed installation instructions.

In Model S, belt-based child restraints can be installed in any passenger seat and ISOFIX systems can be installed in either of the rear outboard seats. Specific details about the type of child restraint system that can be used in each seat is provided next.

NOTE: ISOFIX is an international standard for integrated anchors used in passenger vehicles to attach child safety seats.

⚠ WARNING: Do not use ISOFIX anchors with child restraint system or booster seats that have an integral safety belt where the combined weight of the child plus the child restraint system exceeds 33 kg.

Installing Seat Belt Retained Child Seats

First, make sure that the child safety seat is appropriate for the weight, height, and age of the child.

Avoid dressing the child in bulky clothing and do not place any objects between the child and the restraint system.

Adjust harnesses for every child, every trip.

Always follow the detailed instructions provided by the child safety seat manufacturer. General guidelines are provided below.

1. Place the child safety seat in Model S, and fully extend the seat belt. Route and buckle the seat belt in accordance with the child safety seat manufacturer's instructions.



2. Allow the seat belt to retract, and remove all slack in the seat belt while firmly pushing the child safety seat into the Model S seat.
3. Attach the upper tether strap(s), as required by the manufacturer of the child restraint system (see [Attaching Upper Tether Straps on page 32](#)).

Installing ISOFIX Child Seats

Lower ISOFIX anchors are provided in the rear outboard seats. The anchors are located between the seat's back rest and rear cushion. The exact location of each anchor is identified by a child safety seat identification button, illustrated below. The button is located on the seat back, directly above its associated anchor.

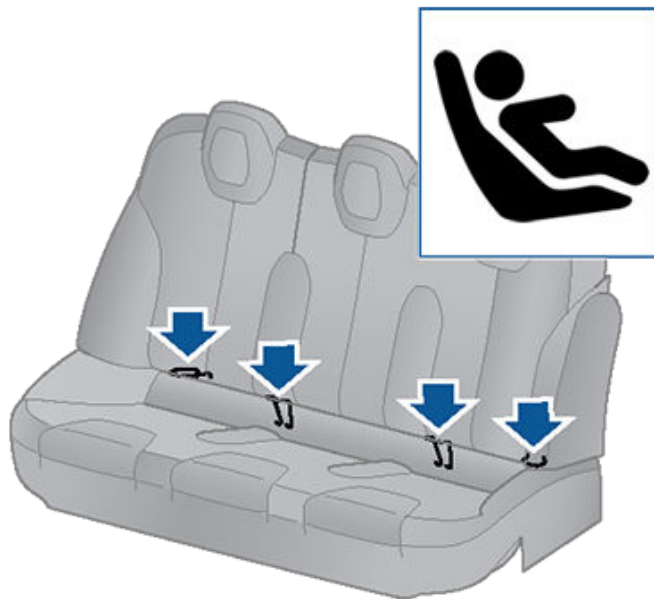

In the rear, install ISOFIX child safety seats in the outboard seating positions only. Use only a seat belt retained seat in the center position.



To install a ISOFIX child safety seat, carefully read and follow the instructions provided by the manufacturer of the child restraint system. These instructions describe how to slide the child restraint system onto the seat's anchor bars until you hear it "click" into place. You may need to push the child restraint system firmly against the seat back to ensure it fits snugly.

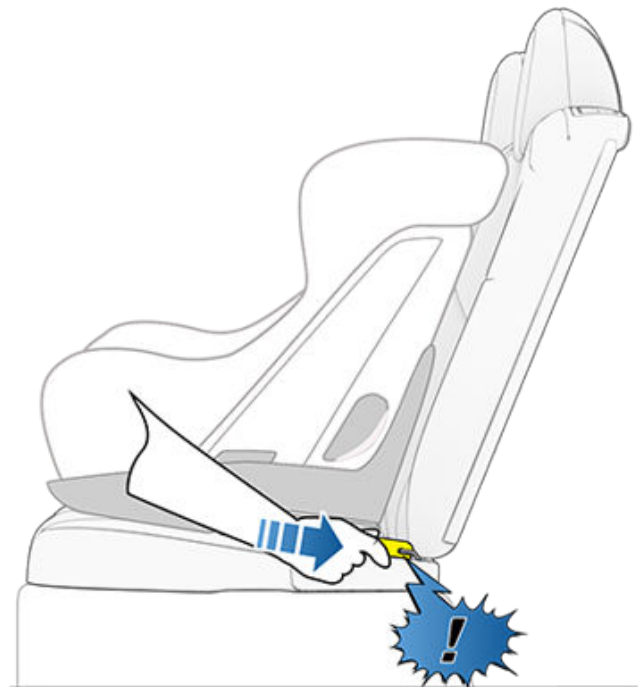

Adjust until the child restraint system is fitted firmly against the seat back. Ensure the child restraint system fits snugly.



Child Safety Seats

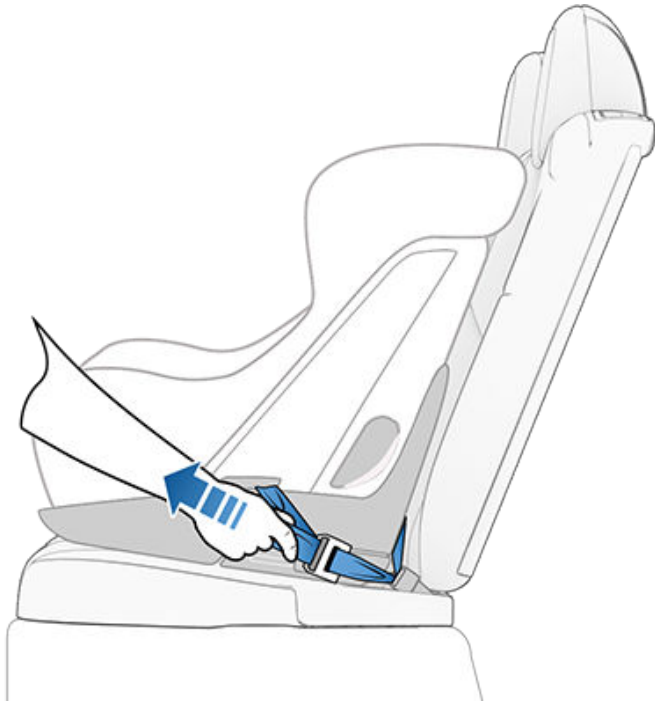

Before seating a child, ensure that the child restraint system is securely installed. Grasp the front of the child restraint system with one hand on each side, and attempt to:

- Twist the child restraint system from side to side.
- Pull the child restraint system away from the seat.

If the child restraint system moves away from the seat, both latches are not fully engaged onto the seat's anchor bars. You must reinstall it and try again. It is critical that both latches on the child restraint system are fully engaged.

⚠ WARNING: Do not use ISOFIX anchors with child restraint system or booster seats that have an integral safety belt where the combined weight of the child plus the child restraint system exceeds 33 kg.

Attaching Upper Tether Straps

If an upper tether strap is provided, attach its hook to the anchor point located on the back of the rear seats.

NOTE: The location of anchor points may not be readily visible but can be found by identifying a slice in the seat's material.

⚠ WARNING: Tighten upper tether straps according to the instructions provided by the manufacturer of the child safety seat.

⚠ WARNING: USE ONLY SEAT BELT RETAINED CHILD SAFETY SEATS IN THE CENTER SEATING POSITION.

For dual-strap tethers, position a strap on each side of the head support.

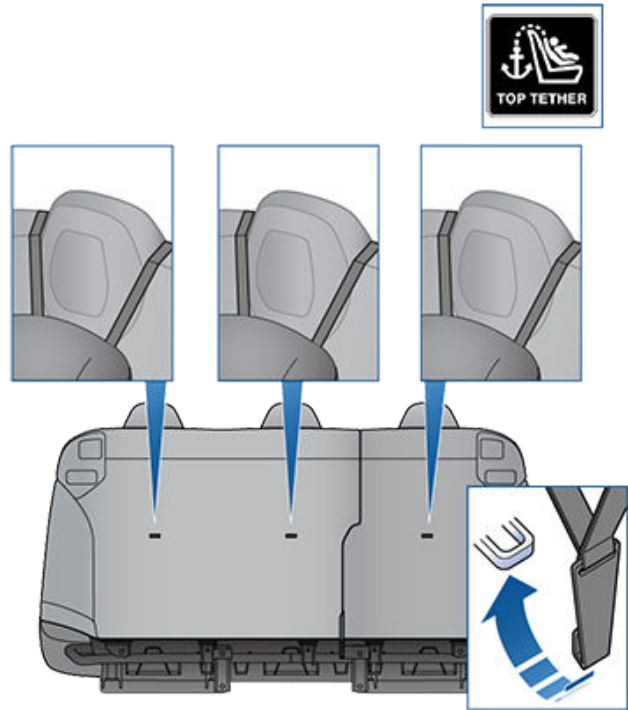

Always position single-strap tethers to run over the top of the head support.

NOTE: To prevent the single-strap tether from moving side to side, the top of the head support deforms.

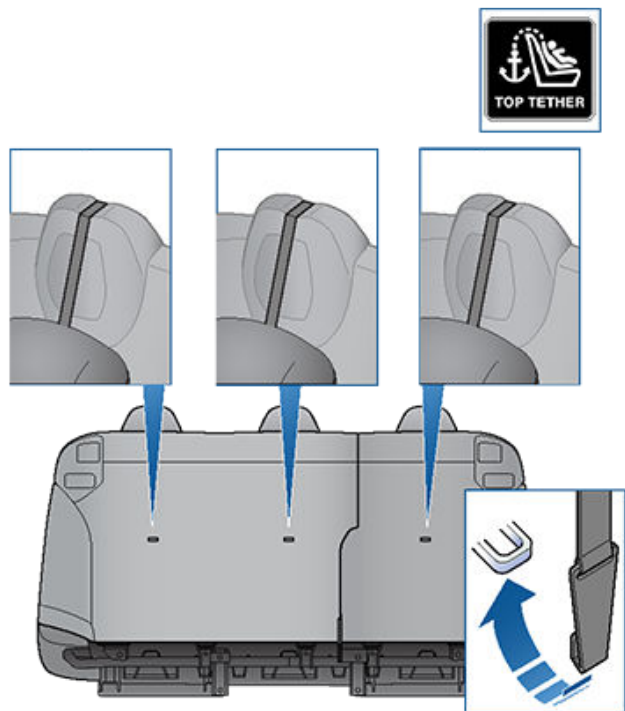

















Testing a Child Safety Seat

Before seating a child, always make sure the child safety seat is not loose:

1. Hold the child safety seat by the belt path and try to slide the safety seat from side to side and front to back.
2. If the seat moves more than 2.5 cm, it is too loose. Tighten the belt or reconnect the ISOFIX retained child safety seat.
3. If you are unable to reduce slack, try a different seat location or try another child safety seat.

Child Safety Seat Warnings

-  **WARNING:** Never seat a child in a child safety seat or a booster seat on the front passenger seat when the airbag is activated. Doing so can cause serious injury or death.
-  **WARNING:** Never use a rearward facing child restraint on a seat protected by an active airbag. Doing so can cause serious injury or death. Refer to the warning label located on the sun visor.
-  **WARNING:** Child restraint systems are designed to be secured in vehicle seats by lap belts or the lap belt portion of a lap-shoulder belt. Children could be endangered in a crash if their child restraints are not properly secured in the vehicle.
-  **WARNING:** According to collision statistics, children are safer when properly restrained in the rear seating positions than in the front seating positions.
-  **WARNING:** Do not use a forward facing child safety seat until your child weighs over 9 kg and can sit independently. Up to the age of two, a child's spine and neck are not sufficiently developed to avoid injury in a frontal impact.
-  **WARNING:** Do not allow a baby or infant to be held on a lap. All children should be restrained in an appropriate child safety seat at all times.
-  **WARNING:** To ensure children are safely seated, follow all instructions provided in this document and by the manufacturer of the child safety seat.
-  **WARNING:** Children should ride in a rear facing child safety seat using the seat's integrated 5-point harness for as long as possible.
-  **WARNING:** Do not use seat belt extenders on a seat belt that is being used to install a child safety seat or booster seat.
-  **WARNING:** When seating larger children, make sure the child's head is supported and the child's seat belt is properly adjusted and fastened. The shoulder portion of the belt must be away from the face and neck, and the lap portion must not be over the stomach.

-  **WARNING:** Never attach two child safety seats to one anchor point. In a collision, one anchor point may be incapable of securing both seats.
-  **WARNING:** Child restraint anchors are designed to withstand only those loads imposed by correctly fitted child restraints. Under no circumstances are they to be used for adult seat belts, harnesses, or for attaching other items or equipment to the vehicle.
-  **WARNING:** Always check harnesses and tether straps for damage and wear.
-  **WARNING:** Never leave a child unattended, even if the child is secured in a child safety seat.
-  **WARNING:** Never use a child safety seat that has been involved in a collision. Have the seat inspected or replaced as described in the child safety seat manufacturer's instructions.



Location of Airbags

Airbags are located in the approximate areas shown below. Airbag warning information is printed on the sun visors.

Model S is equipped with an airbag and lap/shoulder belt at both front seating positions. The airbag is a supplemental restraint at those seating positions. All occupants, including the driver, should always wear their seat belts whether or not an airbag is also provided at their seating position to minimize the risk of severe injury or death in the event of a crash.

NOTE: On RHD (Right Hand Drive) vehicles, the locations of the passenger and driver airbags are reversed.

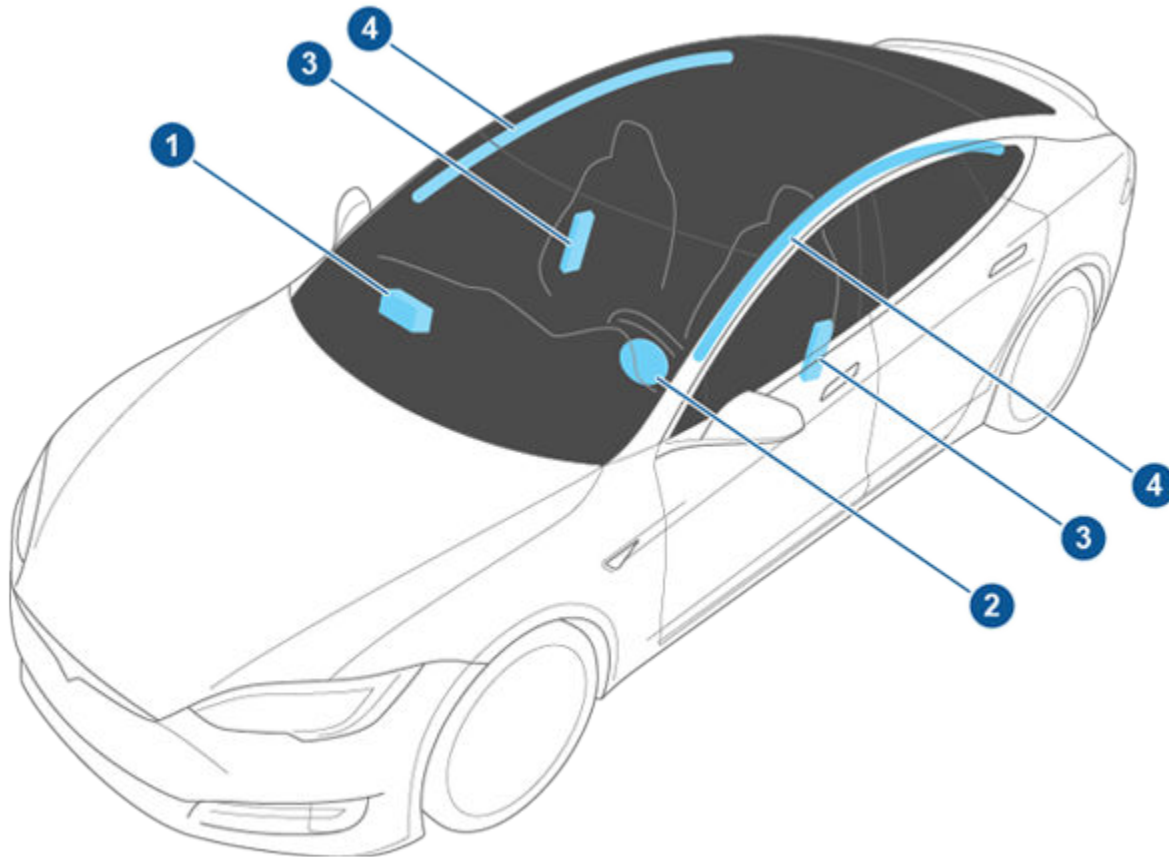

1. Passenger front airbag
2. Driver's front airbag
3. Side airbags
4. Curtain airbags

How Airbags Work

Airbags inflate when sensors detect an impact that exceeds deployment thresholds. These thresholds are designed to predict the severity of a crash in time for the airbags to help protect the vehicle's occupants. Airbags inflate instantly with considerable force accompanied by a loud noise. The inflated bag, together with the seat belts, limits movement of occupants to reduce the risk of injury.

Front airbags are not ordinarily designed to inflate in rear collisions, rollovers, side collisions and when braking heavily or driving over bumps and potholes. Likewise, front airbags may not inflate in all frontal collisions, such as minor front collisions, underride collisions, or minor impacts with narrow objects (such as posts or poles). Significant superficial damage can occur to the vehicle without the airbags inflating and, conversely, a relatively small amount of structural damage can cause airbags to inflate. Therefore, the external appearance of the vehicle after a collision does not represent whether or not the front airbags should have inflated.

 **WARNING:** Before modifying your vehicle to accommodate a person with disabilities in a way that may affect the airbag system, contact Tesla.

Types of Airbags

Model S has the following types of airbags:

- **Front airbags:** The front airbags are designed to reduce injuries if larger children or adults are riding in the front seats. Follow all warnings and instructions related to seating a child on the front passenger seat (if permitted in your market region).
- **Side airbags:** Side airbags protect the thorax region of the torso and the pelvis. They inflate only if a severe side impact occurs. Side airbags on the non-impacted side of the vehicle do not inflate.
- **Curtain airbags:** Curtain airbags help protect the head. Curtain airbags on both the impacted and non-impacted side of the vehicle will inflate only if a severe side impact occurs, or if the vehicle rolls over.

Passenger Front Airbag Status

Model S has a passenger front airbag that is always ON. Children must ride in the rear seats only.

	<p>The Passenger Airbag On indicator displays in the top corner of the touchscreen to indicate that the passenger front airbag may inflate if a collision occurs.</p>
---	---

 **WARNING:** The front passenger seat has an airbag that is always ON. Never seat a child in the front passenger seat, even if using a child restraint system or booster seat. DEATH or SERIOUS INJURY can occur.

Inflation Effects

 **WARNING:** When airbags inflate, a fine powder is released. This powder can irritate the skin and should be thoroughly flushed from the eyes and from any cuts or abrasions.

After inflation, the airbags deflate to provide a gradual cushioning effect for the occupants and to ensure the driver's forward vision is not obscured.

If airbags have inflated, or if your vehicle has been in a collision, always have the airbags, seat belt pretensioners and any associated components checked and, if necessary, replaced by Tesla.

In a collision, in addition to the airbags inflating:

- Doors unlock, and the door handles extend.
- Hazard warning lights turn on.
- Interior lights turn on.
- High voltage is disabled.

To restore high voltage power, use the touchscreen to manually power off Model S (see [Powering Off on page 44](#)), then press the brake to power it back on again.

Airbag Warning Indicator

	<p>The airbag indicator on the instrument cluster remains lit if the airbag system is malfunctioning. The only time this indicator should light up is briefly when Model S first powers up, in which case it turns off within a few seconds. If it remains lit, contact Tesla immediately and do not drive.</p>
---	---

Airbag Warnings









 **WARNING:** Do not place objects over or near airbags because any such objects could cause harm if the vehicle is in a crash severe enough to cause the airbag to inflate.

 **WARNING:** All occupants, including the driver, should always wear their seat belts, whether or not an airbag is also provided at their seating position, to minimize the risk of severe injury or death in the event of a collision.

 **WARNING:** Front seat occupants should not place their arms over the airbag module, as an inflating airbag can cause fractures or other injuries.



Airbags

-  **WARNING:** Do not use seat covers on Model S. Doing so could restrict deployment of the seat-mounted side air bags if a collision occurs. It can also reduce the accuracy of the occupant detection system, if equipped.
-  **WARNING:** Airbags inflate with considerable speed and force, which can cause injury. To limit injuries, ensure that occupants are wearing seat belts and are correctly seated, with the seat positioned as far back as possible.
-  **WARNING:** Children should not be seated on the front passenger seat unless permitted by regulations in your market region. Follow all regulations in your region for the appropriate way to seat a child based on the child's weight, size, and age. The safest place to seat infants and young children is in the rear seating positions. Seating an infant or child in a rear-facing child restraint system on a seat equipped with an operational airbag can cause serious injury or death.
-  **WARNING:** To ensure correct inflation of the side airbags, maintain an unobstructed gap between an occupant's torso and the side of Model S.
-  **WARNING:** Passengers shouldn't lean their heads against doors. Doing so can cause injury if a curtain airbag inflates.
-  **WARNING:** Do not allow passengers to obstruct the operation of an airbag by placing feet, knees or any other part of the body on or near an airbag.
-  **WARNING:** Do not attach or place objects on or near the front airbags, the side of the front seats, the headliner at the side of the vehicle, or any other airbag cover that could interfere with inflation of an airbag. Objects can cause serious injury if the vehicle is in a collision severe enough to cause the airbag to inflate.
-  **WARNING:** Following inflation, some airbag components are hot. Do not touch until they have cooled.



Creating a Driver Profile

When you first adjust the driver's seat, steering wheel, or driver's side mirror, the touchscreen prompts you to create a driver profile to save these adjustments. Your profile also saves some of the preferences you make using the touchscreen's **Controls** window.



To add a new driver profile, touch the driver profile icon at the top of the touchscreen. Then touch **Add New Driver**, type the driver's name and touch **Create Profile**. Follow the onscreen instructions to save the seating position to the driver profile. You can also check the **Use Easy Entry** checkbox if you want to save (or use existing) Easy Entry settings (described below) in which the driver's seat and the steering wheel are automatically adjusted to make it easy to enter and exit Model S.

If you change the position of the steering wheel, driver's seat, or driver's side mirror after you have saved or chosen a driver profile, the touchscreen prompts you to save the new position or restore the previously saved position (other settings are automatically saved). To change a setting without saving or restoring, just ignore the prompt.

To adjust Model S based on a driver's profile, touch the driver profile icon and choose the driver name. The saved adjustments are automatically made.

NOTE: Valet mode is a built-in driver profile used to limit speed and restrict access to some Model S features (see [Valet Mode on page 38](#)).

NOTE: Depending on date of manufacture and options selected at time of purchase, some Model S vehicles are not equipped with the driver profile feature. Also, in cases where the vehicle is equipped with driver profiles, some features may not be automatically saved and adjusted based on the driver profile (for example, mirror position).

NOTE: To stop automatic adjustments that are in process based on a driver's profile, touch Stop on the Driver Profile dropdown menu. Automatic adjustments also stop if you manually adjust a seat, mirror or the steering wheel.

Easy Entry

You can define an Easy Entry setting that moves the steering wheel and driver's seat to make it easy to enter and exit Model S. Any driver can use the Easy Entry setting by associating it with their driver's profile. When the Easy Entry setting is associated with a driver's profile, the steering wheel and driver's seat automatically adjust when the park gear is engaged and

the driver's seat belt is unbuckled, allowing an easy exit from the vehicle. When returning to the vehicle and stepping on the brake pedal, settings automatically adjust back to the settings used by the most recent driver profile (or based on the key if it's linked to a driver profile).

To use **Easy Entry** with a driver profile, ensure the **Use Easy Entry** box is checked.



WARNING: Never use Easy Entry to move the driver's seat to the full rearward position when a child safety seat is installed on a rear seat located behind the driver's seat. With reduced clearance, the movement of the seat may impact a child's legs, cause injury, or dislodge the seat.

Restoring a Driver's Profile



To adjust Model S based on a driver's profile, touch the driver profile icon on the touchscreen's status bar. Then choose the driver and Model S is adjusted based on the settings that have been saved to the chosen driver profile.

Saved Settings

A subset of the settings that you choose from the Controls window to customize your Model S are also saved to your driver's profile. The settings that are associated with driver profiles may vary depending on the version of software currently installed on your Model S.

Linking a Driver Profile to a Key

You can link a driver profile to a specific key to allow Model S to automatically select the correct driver profile when the linked key is detected as you approach the vehicle and open the driver's door. To link a driver profile to a key, enter Model S with the key and touch the driver profile icon on the top of the touchscreen. Select the driver profile you would like to link to the key, then touch **Link to Key Fob**.

NOTE: Model S only detects one key at a time. The driver profile is linked to the key that is detected by the vehicle at that time. Therefore, if you want to link driver profiles to multiple keys, ensure that only the key that you would like to link the driver profile to is within detection range while performing the linking procedure. Move all other keys outside of the detection range (at least one meter away from Model S).

NOTE: Model S can support up to three linked keys. However, a driver profile can only be linked to one key.

To remove the link between a driver profile and key, touch the driver profile icon on the top of the touchscreen. Select the driver profile, then touch the **X** next to **Linked to Key Fob**.



Valet Mode

When Model S is in Valet mode, the following restrictions apply:

- Speed is limited to 113 km/h.
- Maximum acceleration and power are limited.
- Front trunk and glovebox are locked.
- Home and Work locations are not available in the navigation system.
- Voice commands are disabled.
- Autopilot convenience features are disabled.
- Most status bar functions are disabled.
- The Mobile Access setting is disabled.
- HomeLink (if applicable in your market region) is not accessible.
- Driver Profiles are not accessible.
- Wi-Fi and Bluetooth are disabled. When Model S is in Valet mode, you cannot pair new Bluetooth devices or view or delete existing paired devices.

NOTE: If a Bluetooth paired device or a known Wi-Fi network is within operating range (approximately 9 meters) of Model S in Valet mode, Model S will connect to it.

Starting Valet Mode

With Model S in Park, touch the driver profile icon on the top of the touchscreen, then touch **Valet Mode**.

The first time you enter Valet mode, you will be prompted to create a 4-digit PIN that you will use to cancel Valet mode.

When Valet mode is active, the instrument panel displays the word **Valet** above the driving speed and the Valet mode driver profile displays on the touchscreen.

You can also use the mobile app to start and cancel Valet mode (provided Model S is in Park). When using the mobile app, you do not need to enter a PIN because you are already required to log into the app using your Tesla Account credentials.

NOTE: If the **PIN to Drive** setting is enabled (see [PIN to Drive on page 141](#)), you must enter the driving PIN before you can define or enter a Valet PIN. Once in Valet mode, Model S can be driven without the valet needing to enter the driving PIN.

NOTE: The **PIN to Drive** setting is not available when Valet mode is active.

If you forget your valet PIN, reset it from inside Model S by entering your Tesla Account credentials (which also cancels Valet mode). You can also reset your PIN using the mobile app.

Canceling Valet Mode

With Model S in Park, touch the **Valet Mode** driver icon on the touchscreen's status bar, then enter your 4-digit PIN.

When you cancel Valet mode, all settings associated with the most recently used driver profile and climate control settings are restored, and all features are available.

NOTE: You do not need to enter a PIN to cancel Valet mode from the mobile app.



Adjusting Steering Effort

You can adjust the feel and sensitivity of the steering system to suit your personal preference:

1. On the touchscreen, touch **Controls** > **Driving** > **Steering Mode**.
2. Choose a steering option:
 - **Comfort** - Reduces the effort required to turn the wheel. In town, Model S feels easier to drive and park.
 - **Standard** - Tesla believes that this setting offers the best handling and response in all conditions.
 - **Sport** - Increases the effort required to turn the wheel. When driving at higher speeds, Model S feels more responsive.

The only way to really know which option you like best is to try them.

Adjusting Steering Wheel Position

Adjust the steering wheel to the desired driving position by moving the control on the left side of the steering column. Using this control, you can move the steering wheel forward and backward and up and down.

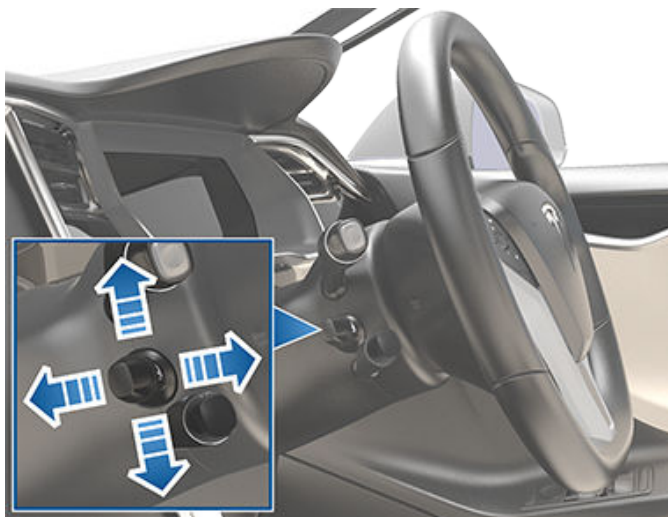

WARNING: Do not make adjustments while driving.

Using Left Steering Wheel Buttons

Use the buttons on the left side of the steering wheel to change radio stations, control the media player's volume, and to choose what displays on the left side of the instrument panel (whenever the Navigation app is not displaying instructions).

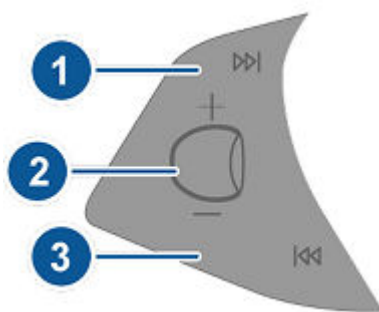

1. Next

If you are listening to local or satellite radio and you have defined more than one radio preset, press to play the next preset in the radio band that is currently playing. If you have not defined more than one preset, press to go to the next available frequency.

If you are listening to Internet radio, or to an audio file on a connected Bluetooth or USB device, press to skip to the next song or station.

If you have more than one favorite defined, press and hold to cycle through favorites.

2. Scroll Button

- To adjust the media volume, roll up or down.

NOTE: The scroll button adjusts the volume for media, navigation instructions and phone calls based on what is currently in use. As you adjust volume, the instrument panel displays the volume level and whether you are adjusting volume for media, navigation or phone.

- To mute the media volume, or to pause/play an audio file, tap the scroll button.
- To choose what displays on the left side of the instrument panel, hold the scroll button briefly until the available options are displayed. Roll the scroll button to choose **Empty**, **Car Status**, **Clock**, **Media**, **Energy**, **Trips**, **Suspension**, etc. When the option you want is highlighted, tap the scroll button.

NOTE: The option you choose to display using the left scroll button is retained until you manually change it. It is also saved in your driver profile.

NOTE: Car status displays information such as status of doors and trunks, and on newer model vehicles, the tire pressure measurements.

- To restart the touchscreen, hold down both scroll buttons for approximately five seconds. See [Restarting the Touchscreen on page 44](#).

3. Previous



Steering Wheel

Same as described above for Next, except it skips to the previous song or station. If you have more than one favorite defined, press and hold to cycle through favorites.

NOTE: Regardless of how you customize the left side of the instrument panel, it automatically changes to display navigation instructions (if applicable), or to let you know if a door or trunk is open when Model S is in a driving gear.

Using Right Steering Wheel Buttons

Use the buttons on the right side of the steering wheel to access call options while on a phone call, to choose what displays on the right side of the instrument panel, to adjust Model S features, and to use voice commands.

NOTE: Whenever you receive or make a phone call, the right side of the instrument panel automatically displays call options to help you easily handle phone calls on your Bluetooth-connected phone.

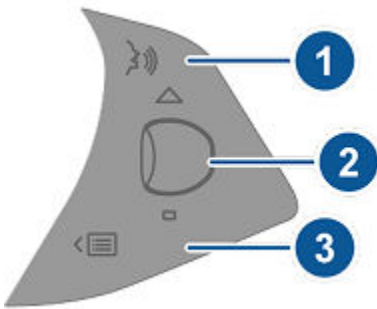

1. Press to use a voice command to call a contact, navigate, or listen to Internet music. When you hear the tone, speak your command. Press again to end the voice command, or simply stop speaking. For details, see [Using Voice Commands on page 40](#).
2. Scroll Button
 - During a phone call, touch the scroll button to display call options that allow you to perform an action on the call.
 - Roll the scroll button to adjust the most recently used feature from the feature list (see Menu button).
 - To choose what displays on the right side of the instrument panel, hold the scroll button briefly until the available options are displayed. Roll the scroll button to choose **Empty**, **Car Status**, **Clock**, **Media**, **Energy**, **Trips**, **Suspension**, etc. When the option you want is highlighted, tap the scroll button.

NOTE: Car status displays information such as status of doors and trunks, and on newer model vehicles, the tire pressure measurements.

NOTE: The option you choose to display using the right scroll button is retained until you manually change it. It is also saved in your driver profile.

- To restart the touchscreen, hold down both scroll buttons for approximately five seconds. See [Restarting the Touchscreen on page 44](#).
- **Suspension.** Display a real-time visualization of how the suspension system is dynamically adjusting each wheel's damping to account for changing road conditions. Roll the scroll button to choose Suspension and then press the scroll button. See [Air Suspension on page 138](#).

3. Menu button

Press to display a menu that allows you to control the following Model S:

- **Temperature.** Roll the scroll button to change the driver side temperature, or press the wheel to turn the climate control system on and off.
- **Fan Speed.** Roll the scroll button to adjust the speed of the fan used to cool or heat the cabin.
- **Display Brightness.** Roll the scroll button to change the brightness level of the displays, or press the wheel to restore default settings.
- **Sunroof** (if equipped). Roll the scroll button to adjust the position of the sunroof.
- **Recent Calls.** If your phone is paired to Model S, roll the scroll button to view your recent calls. Press the scroll button to call the contact that's displayed. To pair your phone, see [Pairing a Bluetooth Phone on page 136](#).
- **Contacts.** If your phone is paired to Model S, roll the scroll button to navigate to contacts in your phone. Your contacts are listed alphabetically by their last name. To pair your phone, see [Pairing a Bluetooth Phone on page 136](#).

Press the menu button again to close the feature list.

Using Voice Commands

You can use voice commands to call a contact, navigate to a location, listen to Internet music or control many aspects of your Model S. Voice commands are designed to understand natural requests. Tap the voice button on the upper right side of the steering wheel to initiate a voice command. When you hear the tone, speak your command. As you speak, the instrument panel displays an interpretation of your command. It also displays tips to remind you of the type of commands you can speak. When you finish speaking the command, tap the voice button again or simply wait.

To choose the language you want to use for voice commands, touch **Controls** > **Display** > **Voice Recognition Language**.



- To call a contact on your Bluetooth-connected phone, say “Call” or “Dial”, followed by the contact’s first and/or last name(s). For example, “Call Joe” or “Call Joe Smith”.
- To search for, or navigate to, a location, say “Where is”, “Drive to”, or “Navigate to”, followed by an address, business name, business category, or landmark. For example, “Where is Stanford University?”, “Drive to Tesla in Palo Alto”, or “Navigate to Starbucks on Homestead in Cupertino”. If you have defined a navigation address for your home or work locations, you can use a voice command to navigate there by saying “Navigate home” or “Navigate to work”.
- To listen to an Internet music service, say “Listen to” or “Play”, followed by the name of the song, album, artist, or combination. To improve voice recognition accuracy, provide multiple cues in your command, such as artist plus song (for example, “Listen to Yellow Brick Road” or “Play Yellow Brick Road by Elton John”).
- Control various aspects of Model S by speaking statements or commands. For example, “Speed up the wipers”, “The screen is too bright”, “Turn on the driver’s seat heater”, “I’m cold”.



For a complete list of voice commands, go to <https://www.tesla.com/support/voice-commands>.

NOTE: Tesla is continuously improving the ability of Model S to recognize voice commands. To support these ongoing quality improvements, Tesla captures short voice recordings anonymously. To protect your privacy, these short recordings are not associated with your personal information or with your vehicle’s identification number. Tesla assures that it is not possible to search any system for a recording associated with a specific customer or vehicle.

Heated Steering Wheel

If Model S is equipped with the optional cold weather package, you can warm up the steering wheel by touching climate controls on the touchscreen (see [Climate Controls on page 123](#)). When turned on, radiant heat keeps the steering wheel at a comfortable temperature.

NOTE: Depending on date of manufacture, your Model S may not include a heated steering wheel, even when equipped with the optional cold weather package.

Horn

To sound the horn, press the center pad on the steering wheel.

Adjusting Exterior Side Mirrors

Press the button associated with the mirror you want to adjust (left or right). The button's light turns on and you can then press the dial to move the mirror to the desired position. Repeat for the other side mirror. If prompted, touch **Save** on the touchscreen to save the mirror adjustment in your driver profile.

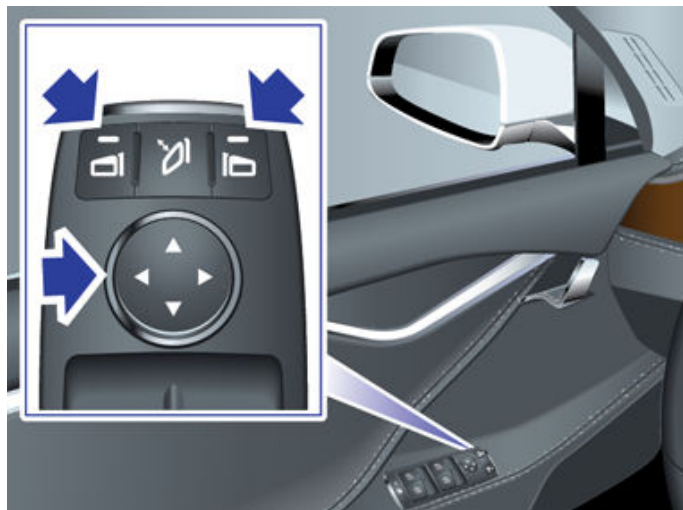

To fold and unfold exterior mirrors, press the center button. You can set the mirrors to fold automatically whenever Model S is locked by touching **Controls > Vehicle > Mirror Auto-Fold**. The mirrors unfold automatically whenever you unlock Model S.

When you use the center button to fold the mirrors in for parking in a tight space, the mirrors remain folded in until your driving speed reaches 50 km/h, or until you use the center button to unfold the mirrors.

NOTE: You cannot fold a mirror if driving above 50 km/h.



The driver's side mirror automatically dims at night, in proportion to the level of glare from the headlights of a vehicle behind you (except when in Reverse gear). Also, both exterior side mirrors have heaters that turn on and off with the rear window defroster.

NOTE: Depending on date of manufacture and options selected at time of purchase, some Model S vehicles are not equipped with a side mirror that automatically dims at night and may not include heated side mirrors. In addition, mirror adjustments may not be saved to your driver profile.

NOTE: See [Cold Weather Best Practices on page 77](#) for information to ensure your mirrors function properly in cold weather.

Auto-Fold Mirrors Based on Location

Model S can automatically fold and unfold the side mirrors based on location, which saves you from having to manually position them each time you need to fold or unfold the mirrors when at a frequented place (such as narrow garages, tight parking spaces, etc.).

To set up, Model S must be driving at a low speed (less than 3 mph/5 kph) or stopped at the location you want your vehicle to remember. Go to **Controls > Vehicle > Always Fold Mirrors at this Location**. Next time you approach the saved location, your mirrors fold and unfold within 25 feet (7.5 meters) of the specified location.

You can also integrate auto-folding mirrors with HomeLink (see [HomeLink Universal Transceiver on page 145](#)). To enable, go to **HomeLink > Auto-Fold Mirrors when Nearby**.

CAUTION: Mirrors may not automatically fold or unfold if you return to a saved location and are driving faster than 3 mph/5 kph.

Mirror Auto-tilt When Reversing

Both exterior mirrors can automatically tilt downward when backing up. To adjust the auto-tilt position, shift into Reverse, then adjust the mirrors (press the button associated with the mirror you want to adjust, then press the dial to move the mirror to the desired position). Touch **Save** on the touchscreen to save the mirror adjustment in your driver profile.

When you shift back into Drive, the mirrors tilt back to their normal (upward) position. But now that you have adjusted them for backing up, they automatically tilt to the selected downward position whenever you shift into Reverse.

You can turn the auto-tilt feature on or off using the touchscreen, Touch **Controls > Vehicle > Mirror Auto-Tilt**.



NOTE: Depending on date of manufacture and options selected at time of purchase, some Model S vehicles are not equipped with Mirror Auto-Tilt.

Rear View Mirror

The rear view mirror is adjusted manually. When in the Drive or Neutral gear, the rear view mirror automatically dims in low lighting conditions (for example, when driving at night or through a tunnel).

Starting

When you open a door, Model S powers on the instrument panel and touchscreen and you can operate all controls.

To drive Model S:

1. **PRESS THE BRAKE PEDAL** - Model S powers on and is ready to drive.
2. **SELECT A GEAR** - Move the drive stalk all the way down for Drive and all the way up for Reverse. See [Shifting Gears on page 46](#).

NOTE: If the PIN to Drive feature is enabled (see [PIN to Drive on page 141](#)), you must also enter a valid PIN on the touchscreen before you can drive Model S.

Everything you need to know when driving Model S displays on the instrument panel.

Key Not Inside

If Model S does not detect a key when you press the brake, the instrument panel displays a message telling you that a key is not inside.

If you receive this message, place the key in the center console cup holder where Model S can best detect it.

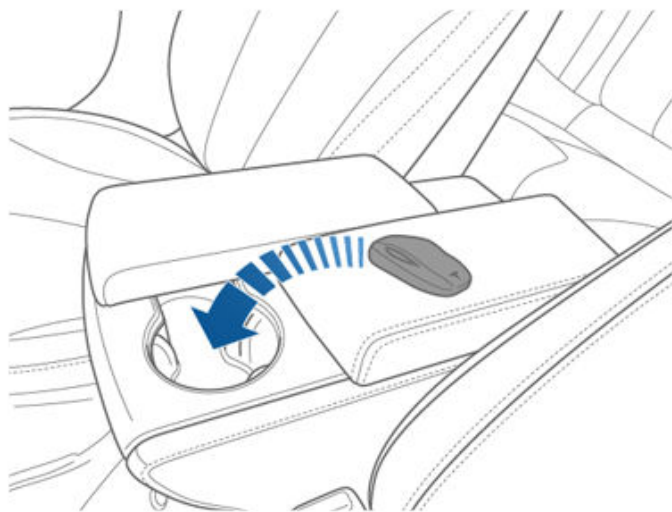

If Model S still does not detect the key, try holding it against the center console, immediately below the 12V power socket (see [12V Power Socket on page 20](#)). Or try using another key. If another key does not work, contact Tesla.

A number of factors can affect whether Model S can detect the key. These include a low battery in the key, interference from other devices using radio signals, and objects between the key and receiver.

Always keep the key with you. After driving, the key is needed to restart Model S after it powers off. And when you leave Model S, you must bring the key with you to lock Model S, either manually or automatically.

Powering Off

When you finish driving, shift into Park by pressing the button on the end of the drive stalk. When you leave Model S with the key, it powers off automatically, turning off the instrument panel and touchscreen.

Model S also powers off automatically after being in Park for 15 minutes, even if you are sitting in the driver's seat.

Although usually not needed, you can power off Model S while sitting in the driver's seat, provided the vehicle is not moving. Touch **Controls > Safety & Security > Power Off**. Model S automatically powers back on again if you press the brake pedal or touch the touchscreen.

NOTE: Model S automatically shifts into Park whenever it is determined that you are exiting the vehicle, even when you shift into Neutral before exiting. To keep Model S in Neutral, see [Keeping Your Vehicle in Neutral \(Tow Mode\) on page 46](#).

Restarting the Touchscreen

If your touchscreen is unresponsive or demonstrates unusual behavior, you can restart it to potentially resolve the issue.

NOTE: To ensure the safety of vehicle occupants as well as other road users, restarting the touchscreen should be done only when the vehicle is in Park.

1. Shift into Park.
2. Hold down both scroll buttons on the steering wheel until the touchscreen turns black.



3. After a few seconds, the Tesla logo appears. Wait approximately 30 seconds for the touchscreen to restart. If the touchscreen is still unresponsive or demonstrating unusual behavior after a few minutes, try power cycling the vehicle. See [Power Cycling the Vehicle on page 45](#).



NOTE: Restarting the touchscreen using the scroll buttons does not power Model S off and on.

Power Cycling the Vehicle

If your vehicle demonstrates unusual behavior or a nondescript alert is present, you can try power cycling the vehicle to potentially resolve the issue.

1. Shift into Park.
2. On the touchscreen, touch **Controls > Safety & Security > Power Off**.
3. Wait for at least two minutes without interacting with the vehicle. Do not open the doors, touch the brake pedal, touch the touchscreen, etc.
4. After two minutes have passed, press the brake pedal or open the door to wake the vehicle.

Shifting Gears

When Model S is in Park, you must press the brake to shift to another gear.

Move the drive stalk up or down to change gears.

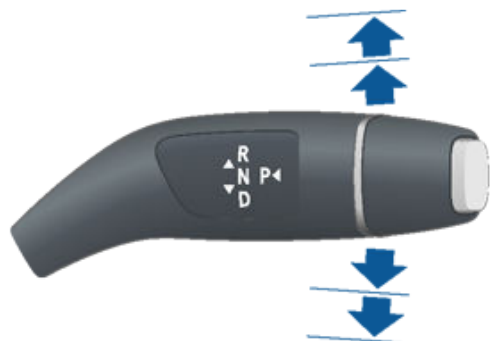

If you try to shift into a gear that the current driving speed prohibits, a chime sounds and the gear does not change.

Reverse

Push the drive stalk all the way up and release. You can only shift into Reverse when Model S is stopped or moving less than 8 km/h.

Neutral

Push the drive stalk up or down to the first position and release to shift into Neutral. Neutral allows Model S to roll freely when you are not pressing the brake pedal.

NOTE: If Autosteer or Traffic-Aware Cruise Control is active, you must push the drive stalk up or down to the first position and hold it there for more than 1 second to shift into Neutral. In doing so, Autosteer or Traffic-Aware Cruise Control is disabled.

NOTE: You must press the brake pedal to shift out of Neutral if driving slower than approximately 8 km/h.

If Model S is in Park and you use the touchscreen to release the parking brake (**Controls > Safety & Security > Parking Brake**), Model S shifts into Neutral (see [Parking Brake on page 61](#)).

Drive

Push the drive stalk all the way down and release. You can shift into Drive when Model S is stopped or moving less than 8 km/h in Reverse.

Park

Press the end of the drive stalk while Model S is stopped.



Model S automatically shifts into Park whenever you connect a charge cable or if two or more of the following conditions are met simultaneously while traveling slower than approximately 2 km/h:

- The driver's seat belt is unbuckled.
- The occupancy sensor in the driver's seat does not detect an occupant.
- The driver's door is opened.

NOTE: You must press the brake pedal to shift *out of* Park.

NOTE: The above conditions do not reflect a comprehensive list of reasons why Model S may or may not automatically shift into Park and, in certain scenarios, it is possible for your vehicle to shift into Park when only one of the above conditions is true.

⚠ WARNING: In emergency situations, if the brakes are not functioning properly, press and hold the Park button on the drive stalk to bring the vehicle to a stop. Do not use this method to stop the vehicle unless absolutely necessary.

⚠ WARNING: It is the driver's responsibility to always ensure the vehicle is in Park before exiting. Never rely on Model S to automatically shift into Park for you; it might not work in all circumstances (for example, if Creep or a slope causes the vehicle to travel greater than approximately 2 km/h).

To make it convenient to pick up passengers, you can also unlock all doors and/or extend the door handles at any time by shifting into Park then pressing the Park button a second time.

Keeping Your Vehicle in Neutral (Tow Mode)

Model S automatically shifts into Park whenever you finish driving and leave Model S. To keep Model S in Neutral when you exit, allowing it to roll freely (for example, pulling onto a transporter, etc.), activate Tow mode:

1. Shift into Park.
2. Press the brake pedal.
3. Touch **Controls > Service > Tow Mode**.

Model S beeps, and shifts into Neutral (which releases the parking brake).



When Tow mode is active, Model S displays this indicator light on the instrument panel, along with a message telling you that Model S will roll freely.

NOTE: In Tow mode, Model S does not shift into a driving gear. To cancel Tow mode, shift into Park or touch Tow mode again. Tow mode also cancels if you use the touchscreen to apply the parking brake (**Controls > Safety & Security > Parking Brake**).

Controlling Lights

Touch **Controls** > **Lights** on the touchscreen to control the lights.

In addition to the lights that you can control from the touchscreen, Model S has convenience lights that turn on and off automatically based on what you are doing. For example, you will notice interior lights, marker lights, tail lights, door handle lights, and puddle lights that turn on when you unlock Model S, when you open a door, and when you shift into Park. They turn off automatically after a minute or two or when you shift into a driving gear or lock Model S.

NOTE: The image below is provided for demonstration purposes only. Depending on vehicle options, software version and market region, your touchscreen may appear slightly different.

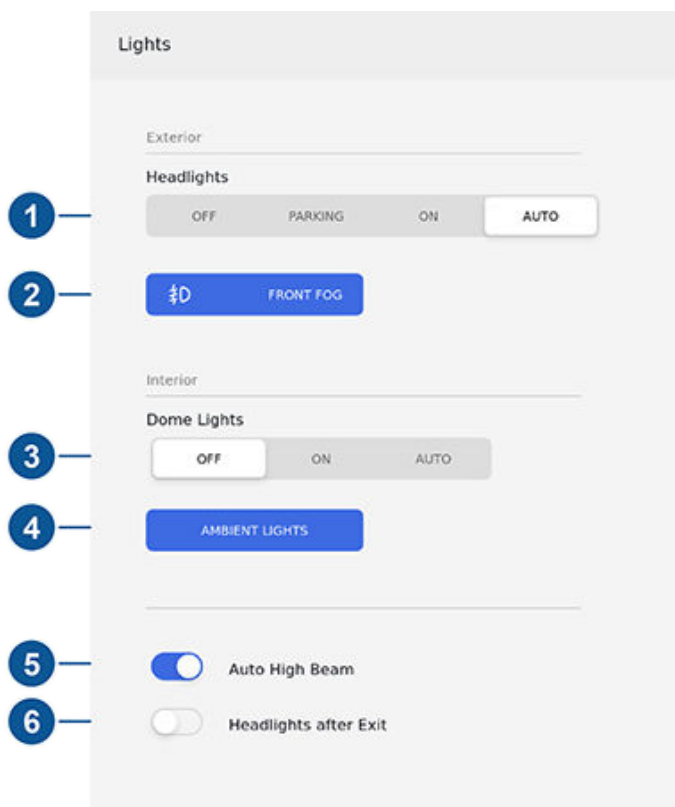

1. Exterior lights (headlights, tail lights, side marker lights, parking lights, and license plate lights) are set to **AUTO** each time you start Model S. When set to **AUTO**, exterior lights automatically turn on when driving in low lighting conditions. If you change to a different setting, lights always revert to **AUTO** on your next drive.

Touch one of these options to temporarily change the exterior light setting:



- **OFF:** Exterior lights turn off until you manually turn them back on or until the next time you drive. If daytime running lights are required in your region, the exterior lights used for this purpose are always on when Drive gear is engaged.
- **PARKING:** Only the side marker lights, parking lights, tail lights and license plate lights turn on.
NOTE: If daytime running lights are required in your region, the exterior lights used for this purpose are always on whenever a driving gear (Drive or Reverse) is engaged.
- **ON:** Exterior lights turn on.

CAUTION: The rear tail lights are off while daytime running lights are on. Be sure the rear lights are on during low rear visibility conditions (for example, when it is dark, foggy, snowy, or the road is wet, etc.). Failure to do so can cause damage or serious injury.

WARNING: Always ensure that your headlights are on during low visibility conditions. Failure to do so may result in a collision.

NOTE: To comply with local traffic regulations when crossing from a left-hand traffic region to a right-hand traffic region, and vice versa, headlights should be adjusted. If you know you will be traveling to a region that requires headlights to be adjusted, schedule a service appointment using the mobile app.

2. If equipped, touch to turn the fog lights on or off. Fog lights operate only when low beam headlights are on. When headlights are turned off, fog lights also turn off.

	<p>The rear fog indicator displays on the instrument panel whenever rear fog lights are on.</p>
	<p>The front fog indicator displays on the instrument panel whenever the optional front fog lights are on.</p>

NOTE: Depending on the market region and vehicle options, your vehicle may not be equipped with front and/or rear fog lights.

NOTE: In some regions, there is no control for the front fog lights. They operate in conjunction with the headlights and turn on only in situations where low beam headlights are on.

3. Turn the interior dome (map) lights on or off. If set to **AUTO**, all interior dome lights turn on when you unlock Model S, open a door upon exiting, or shift into Park.



NOTE: You can also manually turn an individual dome light on or off by pressing its lens. If you manually turn a dome light on, it turns off when Model S powers off. If Model S was already powered off when you manually turned the light on, it turns off after 60 minutes.

4. If you turn on AMBIENT LIGHTS, interior ambient lights turn on whenever the headlights are on.
5. If you turn on Auto High Beam (only available on Model S equipped with Autopilot components), your vehicle automatically switches from high beam headlights to low beam headlights when there is light detected in front of Model S. See [High Beam Headlights on page 50](#).
6. If you turn on Headlights after Exit, the exterior lights remain on for a short period of time after you stop driving and park Model S in low lighting conditions. See [Headlights After Exit on page 50](#).

NOTE: Model S has lights along the rim of the headlights, also referred to as "signature" lights. These lights automatically turn on whenever Model S is powered on and a driving gear is engaged. In market regions where daytime running lights are not required to stay on, the signature lights turn off to conserve energy when you turn on the Range mode setting (if equipped) (see [Controls on page 117](#) or [Driving Tips to Maximize Range on page 71](#)).

High Beam Headlights

Push the turn signal stalk away from you to turn the high beam headlights on continuously. To cancel, pull the stalk towards you.

To briefly flash the high beam headlights, pull the stalk towards you.







The high beam headlights can automatically switch to low beam when there is light detected in front of Model S (for example, from an oncoming vehicle). To turn this feature on or off, go to **Quick Controls** or touch **Controls > Lights > Auto High Beam**.

NOTE: Your chosen setting is retained until you manually change it.

In situations where high beams are turned off because AUTO HIGH BEAM is turned on and light is detected in front of Model S, you can temporarily turn on high beams by pulling the stalk all the way toward you.

The following indicator lights are visible on the instrument panel to show the status of the headlights:

	Low beam headlights are on.
	High beam headlights are on. Illuminates when high beams are on but the Auto High Beam setting is turned off or if the Auto High Beam setting is turned on but is temporarily unavailable.
	High beams are currently turned on, and Auto High Beam is ready to turn off the high beams if light is detected in front of Model S.
	High beams are temporarily turned off because Auto High Beam is on and is detecting light in front of Model S. When light is no longer detected, the high beams will automatically turn back on.

WARNING: Auto High Beam is an aid only and is subject to limitations. It is the driver's responsibility to make sure that the headlights are always adjusted as appropriate for the weather conditions and driving circumstances.

Headlights After Exit

When you stop driving and park Model S in low lighting conditions, the exterior lights remain on. They automatically turn off after one minute or when you lock Model S.

You can turn this feature on and off by touching **Controls > Lights > Headlights After Exit**. When **Headlights After Exit** is off, the headlights turn off when you engage the Park gear and open a door.

Adaptive Front Lighting System (AFS)

If equipped, the Adaptive Front Lighting System (AFS) automatically adjusts the beam of the headlights to improve your driving view. Electric sensors measure driving speed, steering angle and yaw (the rotation of the car around the vertical axis) to determine the optimum position of the headlights based on current driving conditions. For example, to improve visibility while driving on winding roads at night, the AFS casts the beam in the direction of the curve. When low beam headlights are turned on and when driving at lower speeds, AFS improves lateral illumination to increase the visibility of pedestrians and curbs, and to improve visibility when turning at a dark intersection, into a driveway, or when making a u-turn.

The Adaptive Front Lighting System (AFS) operates whenever headlights are on. If Model S isn't moving, or is moving in reverse, the adaptive headlights do not activate. This prevents the lights from inadvertently blinding other drivers.

	If the AFS fails, the instrument panel displays an alert. Contact Tesla Service.
---	--

Turn Signals

Move the turn signal stalk up (before turning right) or down (before turning left). The turn signals flash three times or continuously, depending on how far up or down you move the stalk. Lightly push the stalk up or down for a three-flash sequence. For a continuous signal, push the stalk fully up or down.

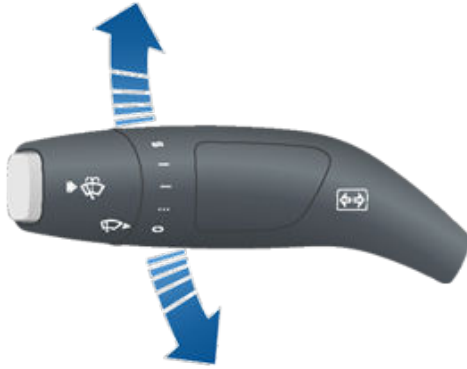

The turn signals stop operating when canceled by the steering wheel, or when you return the stalk to the central position.

	The corresponding turn signal indicator lights up on the instrument panel when a turn signal is operating. You also hear a clicking sound.

⚠ WARNING: If you have purchased an optional Autopilot package, and Traffic-Aware Cruise Control is active, engaging a turn signal can cause Model S to accelerate when using Traffic-Aware Cruise Control in specific situations (see [Overtake Acceleration on page 85](#)).

⚠ WARNING: If you have purchased an optional Autopilot package and Autosteer is active, engaging a turn signal may cause Model S to change lanes.

Hazard Warning Flashers

To turn on the hazard warning flashers, press the button located on the side of the touchscreen closest to the steering wheel. All turn signals flash. Press again to turn off.

NOTE: Hazard warning flashers operate even without a key nearby.

Instrument Panel Overview

The instrument panel changes depending on whether Model S is:





- Off (shown below).
- Driving (see [Instrument Panel - Driving on page 56](#)).
- Charging (see [Charging Status on page 159](#)).

When Model S is off, the instrument panel shows remaining estimated range, status of doors, and outside temperature. When you press the brake, indicator lights flash on briefly along the top. Unless an indicator light applies to a current situation, it should turn off. If an indicator light fails to turn on or off, contact Tesla.











NOTE: The following illustration is provided for demonstration purposes only. Depending on vehicle options, software version, and market region, the information displayed may be slightly different.



The following indicators illuminate on the instrument panel to advise you or alert you of a specific condition.











Indicator	Description
	A brake system fault is detected or the brake fluid level is low. See Braking and Stopping on page 59 . Contact Tesla immediately.
	A brake booster fault has been detected. See Braking and Stopping on page 59 .
	An ABS (Anti-lock Braking System) fault is detected. See Braking and Stopping on page 59 . Contact Tesla immediately.
	The parking brake is manually applied. See Parking Brake on page 61 .





Indicator	Description
	<p>A parking brake fault is detected. Contact Tesla. See Parking Brake on page 61.</p>
	<p>Low beam headlights are on.</p>
	<p>High beam headlights are on. Illuminates when high beams are on but the Auto High Beam setting is turned off or if the Auto High Beam setting is turned on but is temporarily unavailable. See High Beam Headlights on page 50.</p>
	<p>High beam headlights are currently turned on, and Auto High Beam is ready to turn off the high beams if light is detected in front of Model S. See High Beam Headlights on page 50.</p>
	<p>High beam headlights are temporarily turned off because Auto High Beam is on and is detecting light in front of Model S. When light is no longer detected, the high beams automatically turn back on. See High Beam Headlights on page 50.</p>
	<p>Parking lights (side marker lights, tail lights, and license plate lights) are on. See Lights on page 48.</p>
	<p>Front fog lights, if equipped. See Lights on page 48.</p>
	<p>Adaptive Front Lighting, if equipped. See Adaptive Front Lighting System (AFS) on page 50.</p>
	<p>Electronic stability control systems are actively minimizing wheel spin by controlling brake pressure and motor power (indicator flashes amber). See Traction Control on page 63. If this indicator remains on, a fault is detected and you should immediately contact Tesla.</p>
	<p>If a fault is detected that reduces the performance of the air suspension system, this amber indicator light displays. If the problem persists, contact Tesla. See Air Suspension on page 138.</p>



Instrument Panel

Indicator	Description
	If a fault is detected that disables the air suspension system, a red indicator lights up on the instrument panel. Contact Tesla.
	Airbag safety. If this red indicator does not flash on briefly when Model S prepares to drive, or if it remains on, contact Tesla immediately. See Airbags on page 34 .
	Vehicle Hold is actively applying the brakes. See Vehicle Hold on page 66 .
	Tire pressure warning. The pressure of a tire is out of range. If a fault with the Tire Pressure Monitoring System (TPMS) is detected, the indicator flashes. For a TPMS fault, contact Tesla. See Tire Care and Maintenance on page 162 .
	A door or trunk is open. See Keys and Doors on page 10 , Rear Trunk on page 15 , or Front Trunk on page 17 .
	A seat belt for an occupied seat is not fastened. See Seat Belts on page 25 . NOTE: Depending on the date of manufacture, rear seating positions may not be equipped with a seat belt reminder.
	The front passenger's air bag is turned off. See Airbags on page 34 .
	Electronic stability control systems are no longer minimizing wheel spin. On a Rear Wheel Drive vehicle, the traction control system has been turned off, or on an All-Wheel Drive vehicle, Slip Start has been enabled. See Traction Control on page 63 .
	Model S is in Tow mode and can roll freely. It does not automatically shift into Park when you exit. See Instructions for Transporters on page 189 .
	Appears when some of the stored energy in the Battery may not be available due to cold weather conditions. If Model S is plugged in, you can heat your Battery by turning on climate control with the mobile app. The snowflake icon disappears when the Battery is sufficiently warm.
	Vehicle power is currently being limited because the energy remaining in the Battery is low or the vehicle's systems are being heated or cooled.



Indicator	Description
 A green circular icon with a white left-pointing arrow.	Flashes green when the left turn signal is operating. Both turn signal indicators flash green when the hazard warning flashers are operating.
 A green circular icon with a white right-pointing arrow.	Flashes green when the right turn signal is operating. Both turn signal indicators flash green when the hazard warning flashers are operating.



Instrument Panel

Instrument Panel - Driving

When Model S is driving (or ready to drive), the instrument panel shows your current driving status and a real-time visualization of the road as detected by the Autopilot components (see [About Autopilot on page 79](#)). The visualization automatically zooms in and out as needed to inform you when a vehicle is detected in your blind spot.

NOTE: The following illustration is provided for demonstration purposes only. Depending on vehicle options, software version, and market region, the information displayed may be slightly different.

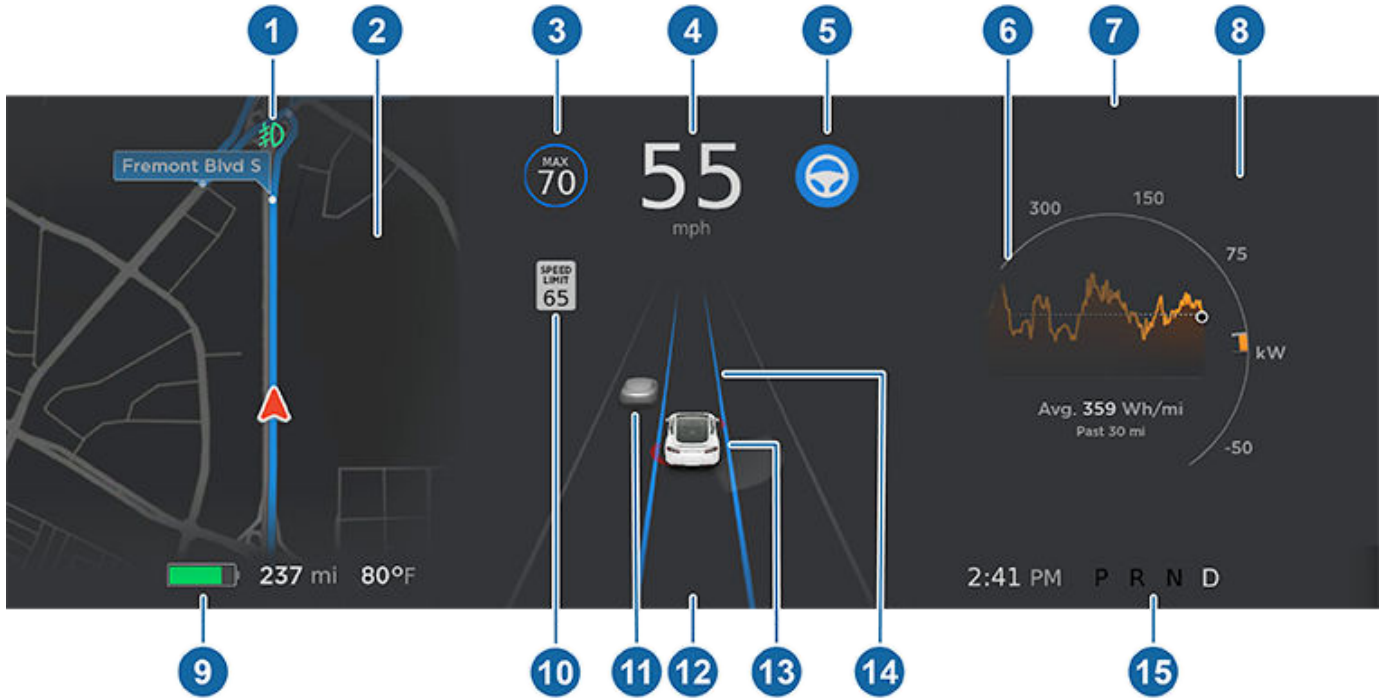

NOTE: Touch **Controls > Autopilot > Full Self-Driving Visualization Preview** (if equipped) to display more details about the roadway and its surroundings, such as road markings, stop lights, objects (such as trash cans and poles), etc.

1. Indicator lights display along the top to provide status (see [Instrument Panel Overview on page 52](#)).
2. When you are actively navigating to a destination, navigation instructions display here. Use the left steering wheel buttons to change what displays on the left side of the instrument panel whenever navigation instructions are not displayed (see [Using Left Steering Wheel Buttons on page 39](#)).
3. Traffic-Aware Cruise Control is cruising at a set speed. When Traffic-Aware Cruise Control is available but you haven't set a cruising speed, the icon is gray and the speed is not shown (see [Traffic-Aware Cruise Control on page 82](#)).
NOTE: On roads where the map data determines that a conditional speed limit exists (for example, a speed limit based on time of day or weather conditions), a second speed limit displays below the first speed limit. It is the driver's responsibility to determine whether the conditional speed limit is currently in effect and adjust the driving speed accordingly.
4. Driving speed.
5. Autosteer is actively steering Model S. When Autosteer is available but you haven't activated it, the icon is gray (see [Autosteer on page 87](#)).
6. On the Energy graph, dashed lines appear on the power meter if Model S is limiting power. The dashed lines appear on the top portion (energy being used) when power available for acceleration is being limited, and on the bottom portion (energy being gained) when power that can be gained by regenerative braking is limited. Model S limits power for many reasons. Here are just a few examples:
 - Acceleration may be limited when the Battery is reaching a low state of charge or if the powertrain is hot.



- Both acceleration and regenerative braking may be limited when the ambient temperature is either very high or very low.
- Regenerative braking may be limited when the Battery is fully charged.

NOTE: Use the right steering wheel buttons to control what displays on the right side of the instrument panel (see [Using Right Steering Wheel Buttons on page 40](#)).

7. Pay attention to important alert messages that display here. If any alerts are in effect, you can view information about them by touching the alert icon (exclamation mark) on the touchscreen's status bar (the topmost area of the touchscreen).
8. Use the right steering wheel buttons to change what displays on the right side of the instrument panel whenever a phone call is not active (see [Using Right Steering Wheel Buttons on page 40](#)).
9. Total estimated driving distance (or energy) available. Instead of driving distance, you can display the percentage of battery energy remaining. To do so, touch **Controls** > **Display** > **Energy Display**.

NOTE: When anticipating when you need to charge, use range estimates as a general guideline only.

10. The speed limit (if available) that is currently being detected by Speed Assist (see [Speed Assist on page 115](#)).
11. The car in front of you (if applicable).
12. Pay attention to important driving-related messages that appear at the bottom center of the instrument panel.
13. Your Model S.
14. When Autosteer is active and detects the driving lane, it is highlighted in blue (see [Autosteer on page 87](#)).

NOTE: If Navigate on Autopilot is active, the driving lane displays as a single blue line in front of Model S (see [Navigate on Autopilot on page 91](#)).

15. Currently selected gear: Park, Reverse, Neutral, or Drive.



WARNING: Although the instrument panel shows surrounding traffic, some vehicles may not be displayed. Never rely on the instrument panel to determine if a vehicle is present (for example, in your blind spot). Always use your mirrors and perform shoulder checks.

Wipers

To wipe the windshield, rotate the end of the turn signal stalk away from you. You can rotate to five positions:

- 1st: Off.
- 2nd: Auto with low rain sensitivity.*
- 3rd: Auto with high rain sensitivity.*
- 4th: Continuous, slow.
- 5th: Continuous, fast.



For a single wipe, press and release the end of the stalk.

If the wipers are set to Auto and Model S detects no liquid on the windshield, the wipers do not wipe.

When you operate the wipers, headlights automatically turn on (if they are not on already).

*To enable the Auto settings, touch **Controls > Vehicle > Autowipers (Beta)**. When wipers are set to Auto, Model S detects whether or not it is raining. The frequency at which they wipe depends on how much rain is detected on the windshield. When wipers are set to high rain sensitivity, the wipers turn on when Model S detects a light mist.

NOTE: The Auto setting is currently in BETA. If uncertain about using the Auto setting while in the BETA phase, Tesla recommends operating the wipers manually, as necessary.

 **CAUTION:** Ensure the wipers are in the Off position before washing Model S to avoid the risk of damaging the wipers.

To extend the life of wiper blades, remove ice from the windshield before turning wipers on. Ice has sharp edges that can damage the rubber on the wiper blades.

Periodically check and clean the edge of the wiper blade. If damaged, replace the wiper blade immediately. For details on checking and replacing wiper blades, see [Wiper Blades and Washer Jets on page 170](#).

 **CAUTION:** In harsh climates, ensure that the wiper blades are not frozen or adhered to the windshield.

De-icing Wipers

To make wiper blades easy to access so you can remove any ice and snow, shift Model S into Park, turn the wipers off, then use the touchscreen to move them to the service position. Touch **Controls > Service > Wiper Service Mode**. When parking in cold outdoor climates, it is helpful to leave Model S with the wipers in the service position. In this position, they are closer to the defrost vent, allowing you to thaw them by directing air from the climate control system towards the windshield.

NOTE: Wipers automatically return to their normal position when you shift Model S out of Park.

If Model S is equipped with the optional cold weather package, you can de-ice wipers by touching the climate control on the touchscreen (see [Climate Controls on page 123](#)). Wiper heaters automatically turns off after 15 minutes.

Washers

Press the button on the end of the turn signal stalk to spray washer fluid onto the windshield. You can press this button at two levels. Press partially for a single wipe, without any washer fluid. Press fully for both wipe and wash. When washing the windshield, the wipers will perform two wipes after you release the button, then a third wipe a few seconds later.



Periodically top up washer fluid (see [Topping Up Windshield Washer Fluid on page 172](#)).

De-icing Washer Nozzles

If Model S is equipped with the optional cold weather package, washer nozzles have de-icers that turn on whenever the ambient temperature nears freezing, or when you turn on the heated wipers (see [Climate Controls on page 123](#)). The washer de-icers turn off when the heated wipers turn off (after 15 minutes), provided the temperature is warm enough to prevent freezing.



Braking Systems

WARNING: Properly functioning braking systems are critical to ensure safety. If you experience a problem with the brake pedal, brake caliper, or any component of a Model S braking system, contact Tesla immediately.

Model S has an anti-lock braking system (ABS) that prevents the wheels from locking when you apply maximum brake pressure. This improves steering control during heavy braking in most road conditions.

During emergency braking conditions, the ABS constantly monitors the speed of each wheel and varies the brake pressure according to the grip available.

The alteration of brake pressure can be felt as a pulsing sensation through the brake pedal. This demonstrates that the ABS is operating and is not a cause for concern. Keep firm and steady pressure on the brake pedal while experiencing the pulsing.

	<p>The ABS indicator briefly flashes yellow on the instrument panel when you first start Model S. If this indicator lights up at any other time, an ABS fault has occurred and the ABS is not operating. Contact Tesla. The braking system remains fully operational and is not affected by an ABS failure. However, braking distances may increase. Drive cautiously and avoid heavy braking.</p>
	<p>If the instrument panel displays this red brake indicator at any time other than briefly when you first start Model S, a brake system fault is detected, or the level of the brake fluid is low. Contact Tesla immediately. Apply steady pressure and keep the brakes firm to bring the vehicle to a stop when safe to do so.</p>
	<p>If the instrument panel displays this yellow brake indicator at any time, a brake booster fault is detected. Apply steady pressure and keep the brakes firm to bring the vehicle to a stop when safe to do so. Hydraulic Boost Compensation will be active (see Hydraulic Boost Compensation on page 60).</p>

Emergency Braking

In an emergency, fully press the brake pedal and maintain firm pressure, even on low traction surfaces. The ABS varies the braking pressure to each wheel according to the amount of traction available. This prevents wheels from locking and ensures that you stop as safely as possible.

WARNING: Do not pump the brake pedal. Doing so interrupts operation of the ABS and can increase braking distance.

WARNING: Always maintain a safe distance from the vehicle in front of you and be aware of hazardous driving conditions. While the ABS can improve stopping distance, it cannot overcome the laws of physics. It also does not prevent the danger of hydroplaning (where a layer of water prevents direct contact between the tires and the road).

Automatic Emergency Braking is designed to automatically brake in situations where a collision is considered imminent (see [Automatic Emergency Braking on page 113](#)).

WARNING: Automatic Emergency Braking is not designed to prevent a collision. At best, it can minimize the impact of a frontal collision by attempting to reduce your driving speed. Depending on Automatic Emergency Braking to avoid a collision can result in serious injury or death.

CAUTION: In emergency situations, if the brakes are not functioning properly, press and hold the Park button on the drive stalk to bring the vehicle to a stop. Do not use this method to stop the vehicle unless absolutely necessary.

Brake Disc Wiping

To ensure your brakes remain responsive in cold and wet weather, Model S is equipped with brake disc wiping. When cold and wet weather is detected, this feature repeatedly applies an imperceptible amount of brake force to clear away water from the surface of the brake discs.

Hydraulic Fade Compensation

Your vehicle is also equipped with hydraulic fade compensation. This feature assists in monitoring brake system pressure and ABS activity for instances of lower brake performance. If lower brake performance is detected (for example, as a result of brake fade, or cold or wet conditions), you may feel the brake pedal pull away from your foot, detect some noise, and notice a strong increase in vehicle braking. Continue to press the brake pedal without releasing or "pumping" them—brake as you normally would.

CAUTION: If brakes are not functioning properly, stop the vehicle as soon as safety permits and contact Tesla Service. See [Park on page 46](#) for information on using the Park button to stop the vehicle in case of emergency.



Braking and Stopping

WARNING: Always maintain a safe driving distance from the vehicle in front of you and exercise caution when driving conditions are hazardous. Do not rely on brake disc wiping or hydraulic fade compensation to act as a substitute for adequately applying the brakes.

Hydraulic Boost Compensation

Model S is equipped with a brake booster that provides a mechanical advantage that effectively activates the brakes when the brake pedal is pressed. Hydraulic boost compensation provides mechanical assist in the event of a brake booster failure. If a brake booster failure is detected, the brake pedal may feel harder to press and you may hear some noise when you press the brake pedal. To stop the vehicle, apply adequate steady force on the brake pedal without releasing or "pumping" them. Exercise caution while driving and maintain a safe distance as brake pedal responsiveness and braking performance may be degraded.

Regenerative Braking

Whenever Model S is moving and your foot is off the accelerator, regenerative braking slows down Model S and feeds any surplus energy back to the Battery.

By anticipating your stops and reducing or removing pressure from the accelerator pedal to slow down, you can take advantage of regenerative braking to increase driving range. Of course, this is no substitute for regular braking when needed for safety.

NOTE: If regenerative braking is aggressively slowing Model S (such as when your foot is completely off the accelerator pedal at highway speeds), the brake lights turn on to alert others that you are slowing down.

WARNING: In snowy or icy conditions Model S may experience traction loss during regenerative braking, particularly when in the **Standard** setting and/or not using winter tires. Tesla recommends using the **Low** setting (see [To Set the Regenerative Braking Level on page 60](#)) in snowy or icy conditions to help maintain vehicle stability.

The Energy app displays real-time feedback on the amount of energy being gained by regenerative braking. You can also display the power meter on either side of the instrument panel by choosing **Energy** using the scroll button on the steering wheel (see [Steering Wheel on page 39](#)).

The amount of energy fed back to the Battery using regenerative braking can depend on the current state of the Battery. For example, regenerative braking may be limited if the Battery is already fully charged or if the ambient temperature is too cold.

NOTE: If regenerative braking is limited, a dashed yellow line displays on the power meter.



To Set the Regenerative Braking Level

NOTE: The regenerative braking setting is not available on all vehicles.

You can use the touchscreen to change the level of regenerative braking:

1. Touch **Controls > Driving > Regenerative Braking**.
2. Choose from two levels:
 - **Standard:** Provides the maximum amount of regenerative braking. When you release the accelerator, Model S slows down, reducing the need to use the brakes.
 - **Low:** Limits regenerative braking. When you release the accelerator, Model S takes longer to slow down and coasts further than if set to "Standard".

Stopping Mode

Regenerative braking decelerates Model S whenever you release the accelerator pedal when driving. You can choose what you want Model S to do once the driving speed has been reduced to a very low speed (almost at a stop) and both the accelerator pedal and brake pedal are released. While in Park, touch **Controls > Driving > Stopping Mode** and choose from these options:

- **CREEP:** When close to, or at, a complete stop, the motor continues to apply torque, moving Model S slowly forward (in Drive) or backwards (in Reverse), similar to a conventional vehicle with an automatic transmission. In some situations, such as on a steep hill or driveway, you may need to press the accelerator pedal to continue moving or to prevent Model S from moving in the opposite direction.



⚠ WARNING: Never rely on CREEP to apply enough torque to prevent your vehicle from rolling down a hill. Always press the brake pedal to remain stopped or the accelerator pedal to proceed up the hill. Failure to do so can result in property damage and/or a collision.

- **HOLD:** Maximizes range and reduces brake wear by continuing to provide regenerative braking at speeds lower than with the Creep and Roll settings. When Model S stops, the brakes are automatically applied without you having to put your foot on the brake pedal. Whether stopped on a flat surface or a hill, Vehicle Hold keeps the brake applied, provided your foot remains off the accelerator and brake pedals. See [Vehicle Hold on page 66](#).

⚠ WARNING: Never rely on HOLD to adequately decelerate or fully stop your vehicle. Many factors can contribute to a longer stopping distance, including downward slopes, the low regenerative braking setting, and reduced or limited regenerative braking (see [Regenerative Braking on page 60](#)). Always be prepared to use the brake pedal to adequately decelerate or stop.

- **ROLL:** When close to, or at, a complete stop, Model S becomes free rolling like a vehicle in Neutral. Therefore, if stopped on a slope, Model S will roll downward. The brake does not engage, and the motor does not apply torque (until the accelerator pedal is pressed).

NOTE: If you choose CREEP or ROLL, you can still use Vehicle Hold to apply the brakes. However, you will need to briefly press the brake pedal when the vehicle is stopped. See [Vehicle Hold on page 66](#).

⚠ WARNING: Press the brake pedal if Model S moves when unsafe to do so. It is your responsibility to stay alert and be in control of the vehicle at all times. Failure to do so can result in serious damage, injury, or death.

⚠ WARNING: Do not rely on regenerative braking and your chosen Stopping Mode to keep you and your vehicle safe. Various factors such as driving with a heavy vehicle load, on a steep hill, or on wet or icy roads affect deceleration rate and the distance at which Model S will come to a stop. Drive attentively and always stay prepared to use the brake pedal to stop as appropriate based on traffic and road conditions.

⚠ WARNING: Forward Collision Warning and Automatic Emergency Braking do not operate when driving at very low speeds (see [Collision Avoidance Assist on page 112](#)). Do not rely on these features to warn you, or to prevent or reduce the impact of a collision.

NOTE: Your chosen setting is retained in your Driver Profile until you manually change it.

Parking Brake

To engage the parking brake, touch **Controls > Safety & Security > Parking Brake** and follow the onscreen instructions. You can also engage the parking brake by pressing and holding the button on the end of the drive stalk while in Park.



NOTE: The parking brake operates on the rear wheels only, and is independent of the pedal-operated brake system.

⚠ WARNING: In snowy or icy conditions the rear wheels may not have sufficient traction to prevent Model S from sliding down a slope, particularly if not using winter tires. Avoid parking on hills in snowy or icy conditions. You are always responsible for parking safely.

⚠ WARNING: Your Model S may display an alert if the road is too steep to safely park on, or if the parking brakes are not properly engaged. These alerts are for guidance purposes only and are not a substitute for the driver's judgment of safe parking conditions, including specific road or weather conditions. Do not depend on these alerts to determine whether or not it is safe to park at any location. You are always responsible for parking safely.

Use the touchscreen to manually release the parking brake (which also shifts Model S into Neutral):

1. Touch **Controls > Safety & Security**.
2. Press the brake pedal, then touch **Parking Brake**. If Model S was previously in Park, it shifts into Neutral.



When you manually apply the parking brake using the touchscreen (**Controls > Safety & Security > Parking Brake**), or by pressing and holding the button on the end of the drive stalk when in Park, the red parking brake indicator lights up on the instrument panel.



If the parking brake experiences an electrical issue, the amber parking brake indicator lights up and a fault message displays at the top of the instrument panel.



CAUTION: In the unlikely event that Model S loses electrical power, you cannot access the touchscreen and are therefore unable to release the parking brake. Contact Tesla.



Braking and Stopping

Brake Wear

Model S brake pads are equipped with wear indicators. A wear indicator is a thin metal strip attached to the brake pad that squeals as it rubs against the rotor when the pad wears down. This squealing sound indicates that the brake pads have reached the end of their service life and require replacement. To replace the brake pads, contact Tesla Service.

Brakes must be periodically inspected visually by removing the tire and wheel. For detailed specifications and service limits for rotors and brake pads, see [Subsystems on page 181](#). Additionally, Tesla recommends cleaning and lubricating the brake calipers every year or 20,000 km if in an area where roads are salted during winter months.

 **WARNING:** Neglecting to replace worn brake pads damages the braking system and can result in a braking hazard.



How It Works

The traction control system constantly monitors the speed of the front and rear wheels. If Model S experiences a loss of traction, the system minimizes wheel spin by controlling brake pressure and motor power. By default, the traction control system is on. Under normal conditions, it should remain on to ensure maximum safety.



This yellow indicator flashes on the instrument panel whenever the traction control system is actively controlling brake pressure and motor power to minimize wheel spin. If the indicator stays on, a fault is detected with the traction control system. Contact Tesla Service.



WARNING: Traction control cannot prevent collisions caused by driving dangerously or turning too sharply at high speeds.

Allowing Wheel Slip

To allow the wheels to spin at a limited speed, you can enable Slip Start. Slip Start can be enabled only when Model S is moving 48 km/h or slower. Slip Start automatically disables when the speed exceeds 80 km/h.

Under normal conditions, Slip Start should not be enabled. Enable it only in circumstances where you deliberately want the wheels to spin, such as:

- Starting on a loose surface, such as gravel or snow.
- Driving in deep snow, sand or mud.
- Rocking out of a hole or deep rut.

To allow the wheels to spin, touch **Controls > Driving > Traction Control > Slip Start**.



The instrument panel displays an alert message when Slip Start is enabled.

Although Slip Start is automatically disabled the next time you start Model S, it is strongly recommended that you disable it immediately after the circumstances that required you to enable it have passed.

NOTE: Slip Start cannot be enabled when you are actively using Traffic-Aware Cruise Control.



How Park Assist Works

Model S has several sensors designed to detect the presence of objects. When driving slowly in Drive or Reverse (for example, when parking), the sensors alert you if an object is detected in close proximity of your Model S. Objects are only detected in the direction of the gear you selected; front objects in Drive, rear objects in Reverse.

WARNING: You may not be alerted if Model S rolls freely in the opposite direction of the gear you selected (for example, you will not receive an alert if Model S rolls backwards down a hill while in Drive).

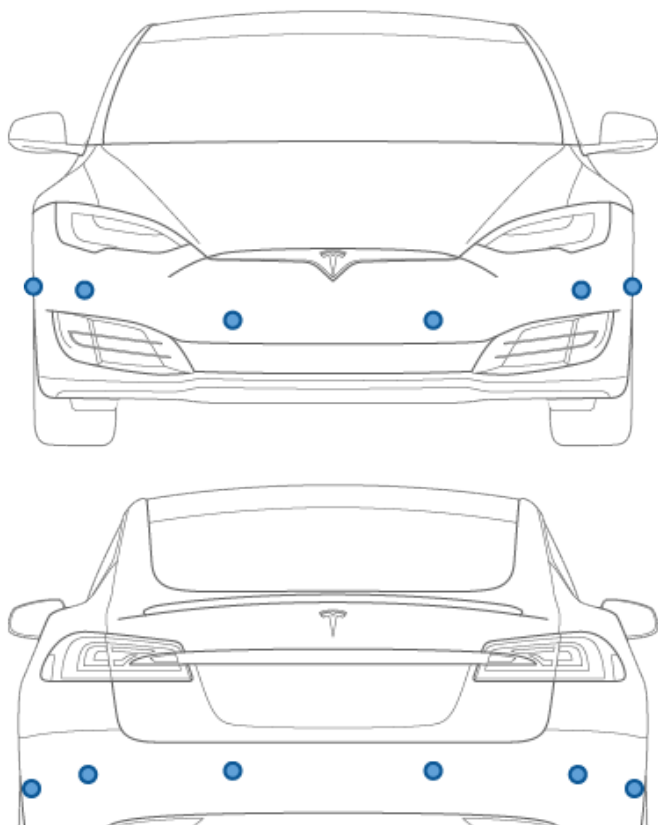

The sensors are activated when driving slower than 8 km/h.

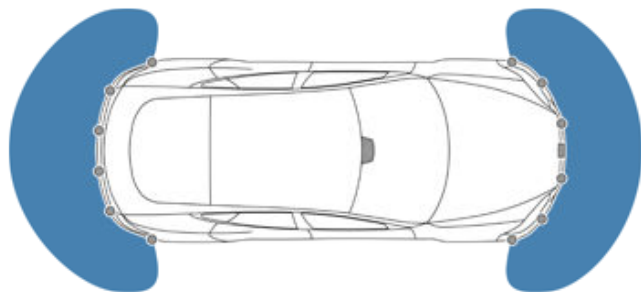

WARNING: Never depend on Park Assist to inform you if an area you are approaching is free of objects and/or people. Several external factors can reduce the performance of Park Assist, causing either no readings or false readings (see [Limitations and False Warnings on page 65](#)). Therefore, depending on Park Assist to determine if Model S is approaching an obstruction can result in damage to the vehicle and/or objects, and can potentially cause serious injury. Always inspect the area with your own eyes. When reversing, perform shoulder checks and use all mirrors. Park assist does not detect children, pedestrians, bicyclists, animals, or objects that are moving, protruding, located too far above or below the sensors, or too close or too far from the sensors. Park Assist is for guidance purposes only and is not intended to replace your own direct visual checks. It is not a substitute for careful driving.

Visual and Audio Feedback

When you shift to Reverse, the Park Assist view displays on the left side of the instrument panel, showing objects that are in close proximity to the front and rear of Model S. This view closes when you shift into Drive unless an object is detected close to the front of Model S, in which case the Park Assist view closes automatically when your driving speed exceeds 8 km/h. When reversing, visual feedback also displays on the touchscreen, immediately below the camera view (see [Rear View Camera on page 73](#)). You can manually close the park assist view on the touchscreen by touching the X in the upper corner.

When driving with the Camera app displayed on the touchscreen, you can switch to the Park Assist view when driving at speeds below 8 km/h. Touch the button located in the upper left corner of the Camera app window. This is useful if you need assistance with parallel parking.

If chimes are turned on (see [Controlling Audible Feedback on page 65](#)), an audible beep sounds as you approach an object. You can temporarily mute the chime by pressing the scroll button on the left side of the steering wheel or by touching the mute button on the bottom left corner of the Park Assist view.

NOTE: If a sensor is unable to provide feedback, the instrument panel displays an alert message.

CAUTION: Keep sensors clean from dirt, debris, snow, and ice. Avoid using a high pressure power washer on the sensors and do not clean a sensor with a sharp or abrasive object that can scratch or damage its surface.

CAUTION: Do not install accessories or stickers on or near the parking sensors.

Controlling Audible Feedback

You can use Park Assist with or without audible feedback. To turn chimes on or off, touch **Controls > Safety & Security > Park Assist Chimes**.

To mute the chimes temporarily, press the scroll button on the left side of the steering wheel or touch the mute button in the corner of the Park Assist view. The chimes are muted until you shift into a different gear or drive over 8 km/h.

Limitations and False Warnings

The parking sensors may not function correctly in these situations:

- One or more of the parking sensors is damaged, dirty, or covered (such as mud, ice, or snow).
- The object is located below approximately 20 cm (such as a curb or low barrier).
 - ⚠ **CAUTION:** Shorter objects that are detected (such as curbs or low barriers) can move into the blind spot of the sensors. Model S cannot alert you about an object while it is in the blind spot of the sensors.
- Weather conditions (heavy rain, snow, or fog) are interfering with sensor operation.
- The object is thin (such as a sign post).
- A sensor's operating range has been exceeded.
- The object is sound-absorbing or soft (such as powder snow).
- The object is sloped (such as a sloped embankment).
- Model S has been parked in, or being driven in, extremely hot or cold temperatures.
- The sensors are affected by other electrical equipment or devices that generate ultrasonic waves.
- You are driving in a location where the sensors' ultrasonic waves are deflected away from the vehicle (such as driving next to a wall or pillar).
- The object is located too close to the bumper.
- A bumper is misaligned or damaged.
- An object that is mounted to Model S is interfering with and/or obstructing the sensor (such as a bike rack or bumper sticker).
- Model S rolls freely in the opposite direction of the gear you selected (for example, you will not receive an alert if Model S rolls backwards down a hill while in Drive).

Other Parking Aids

In addition to Park Assist, when shifted into Reverse, the backup camera displays a view of the area behind Model S (see [Rear View Camera on page 73](#)).



Vehicle Hold

When Model S is stopped, Vehicle Hold can continue to apply the brakes even after you remove your foot from the brake pedal. When driving on a hill or on a flat surface, brake as you normally would. After coming to a complete stop, simply press the brake pedal again (until the instrument panel displays the Vehicle Hold indicator light) to enable Vehicle Hold. You can then release the brake pedal and remain stopped, even on a hill.



This indicator displays on the instrument panel whenever Vehicle Hold is actively braking Model S.

To disengage Vehicle Hold, press the accelerator pedal or press and release the brake pedal.

NOTE: Shifting into Neutral also disengages Vehicle Hold.

NOTE: After actively braking Model S for approximately ten minutes, Model S shifts into Park and Vehicle Hold cancels. Model S also shifts into Park if it detects that the driver has left the vehicle.

NOTE: When Stopping Mode is set to Hold (see [Stopping Mode on page 60](#)), Vehicle Hold engages automatically whenever Model S stops while in a driving gear. There is no need to press the brake to engage it.



The acceleration settings available on your Model S vary depending on date of manufacture and options chosen at time of purchase:

- **Chill:** limits acceleration for a smooth and gentle ride (available on all vehicles equipped with Autopilot hardware).
- **Standard:** provides the normal level of acceleration (available on non-Performance All-Wheel Drive vehicles and Rear Wheel Drive Model S vehicles equipped with Autopilot hardware).
- **Sport:** provides the normal level of acceleration (available on Performance All-Wheel Drive vehicles).
- **Insane:** increases peak torque by approximately 30 percent (available on Performance All-Wheel Drive vehicles not equipped with the Ludicrous upgrade).
- **Ludicrous:** increases peak torque by approximately 60 percent (available on Performance All-Wheel Drive vehicles equipped with the Ludicrous upgrade).
- **Insane+:** increases peak torque by approximately 30 percent (available on Performance All-Wheel Drive vehicles not equipped with the Ludicrous upgrade) while also heating up the Battery to its ideal operating temperature to ensure access to 100% of available power. Before choosing this setting, read about [Using Insane+ or Ludicrous+ on page 67](#).
- **Ludicrous+:** increases peak torque by approximately 60 percent (available on Performance All-Wheel Drive vehicles equipped with the Ludicrous upgrade) while also immediately heating up the Battery to its ideal operating temperature to ensure access to 100% of available power. Before choosing this setting, read about [Using Insane+ or Ludicrous+ on page 67](#).

NOTE: Although Chill does not directly improve driving range, using the increased torque and power available in Insane or Ludicrous mode can reduce range and efficiency.

NOTE: When Chill is selected, Chill displays on the instrument panel above the driving speed.

In addition, a Performance All-Wheel Drive Model S also features Launch Mode to provide optimum acceleration on surfaces with good traction. For the specific driving instructions required to use Launch Mode, see [Launch Mode on page 67](#).

To choose an acceleration mode, touch **Controls** > **Driving** > **Acceleration**.

Using Insane+ or Ludicrous+

If you choose Insane or Ludicrous, additional power is available immediately. However, to achieve the absolute maximum power (designed for short term use), you can choose **Insane+** or **Ludicrous+** to heat the Battery to its ideal operating temperature. This ensure access to 100% of available power.

While the battery is being heated, the touchscreen displays a status message providing you with an approximate wait time, and letting you know when the additional power is available. In addition to heating the Battery, **Insane+** and **Ludicrous+** modes strive to keep the Battery within an optimal temperature range. Therefore, under aggressive driving scenarios, you may also see the “Cooling” status for several minutes until temperatures fall. Model S stays in the chosen mode for three hours, even if you leave the vehicle. After three hours, the feature times out.

NOTE: Insane+ and Ludicrous+ are designed to achieve maximum performance for short term acceleration. These settings are not intended for daily driving. The tradeoff for the additional power boost is extra energy consumption and earlier power fade on long drives. The Insane or Ludicrous acceleration settings provide a significant increase in performance even without choosing the Insane+ or Ludicrous+ setting to achieve maximum Battery power. In fact, in normal driving situations, the additional power that can be achieved using Insane+ and Ludicrous+ may be unnoticeable.

NOTE: To support Insane+ or Ludicrous+, the charge level must be 20% or higher. You cannot initiate these settings if the charge level is less than 20%. In addition, these settings immediately cancel if at any time during use, the charge level drops below 20%.

When using Insane+ or Ludicrous+, Model S consumes more energy to keep the Battery within an optimal temperature range.

To cancel Insane+ or Ludicrous+ at any time, change the acceleration level to another setting. To prevent excess and potentially unnecessary energy consumption (for example, you leave the vehicle and forget to cancel Insane+ or Ludicrous+), these settings cancel automatically in three hours, regardless of whether you are still driving or have left the vehicle.

NOTE: Insane+ or Ludicrous+ strives to keep the Battery within an optimal temperature range. In addition to heating the Battery, these settings also cool the battery when necessary (for example, while driving at high speeds, during rapid acceleration, driving for long periods, etc.).

Launch Mode

Launch Mode, available on Performance All-Wheel Drive vehicles only, provides optimum acceleration on surfaces with good traction.

NOTE: Hard acceleration including, but not limited to, using launch mode, increases stress on the vehicle’s powertrain, and can cause premature wear and aging of various components. Model S constantly monitors powertrain fatigue and damage, and notifies you if vehicle components need to be serviced.



Acceleration Modes

⚠ WARNING: Use Launch Mode only in appropriate locations where there is no cross traffic or pedestrians present. Launch Mode is designed for use on closed circuit driving courses. It is the driver's responsibility to ensure that driving style and acceleration do not endanger or inconvenience other road users.

To Activate Launch Mode

1. Ensure the brakes are slightly warm by driving for a few minutes and using the brakes a few times.
2. Set the air suspension to Low (see [Air Suspension on page 138](#)).
3. Set the acceleration level to **Insane+** or **Ludicrous+** (if equipped).

NOTE: If equipped with the **Ludicrous+** setting, you can achieve optimum performance by pressing and holding this setting for three seconds.

4. With Model S shifted into Drive and at a complete stop with the steering wheel straight, firmly hold the brake pedal with your left foot, then fully press the accelerator pedal. Within one second, the instrument panel displays a message indicating that Launch Mode is enabled.

NOTE: Launch mode further lowers the front suspension, significantly reducing ground clearance.

5. Within twelve seconds of Launch Mode being enabled, release the brake pedal to launch the vehicle.

When you release the brake, Model S launches forward.

NOTE: Launch Mode is not available if Slip Start has been enabled (which allows the wheels to spin). See [Traction Control on page 63](#).

NOTE: Launch Mode is available only if the ambient temperature is 3° C or warmer.

How Active Hood Works

NOTE: The pedestrian protection system relies on a series of sensors and algorithms designed and calibrated to determine when Active Hood should deploy. Therefore, not all pedestrian collisions result in deployment. Similarly, the Active Hood may deploy if Model S collides with an animal, vehicle, or other object.

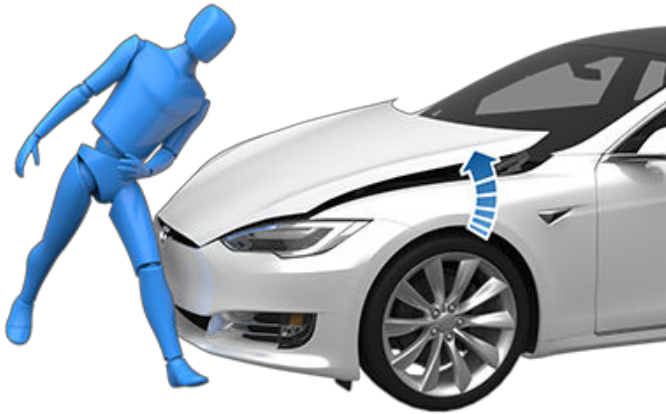

If Active Hood has been deployed, the instrument panel displays an alert and a chime sounds. Immediately take Model S to the nearest Tesla Service Center or Tesla-approved body shop. Active Hood's associated sensors and actuators must be serviced whenever Active Hood has been deployed.

⚠ WARNING: Deployment of Active Hood may cause the raised hood to partially obstruct driver vision, increasing the risk of a collision. If safe to do so, Model S can be driven to the nearest Tesla Service Center or Tesla-approved body shop. If unsafe to drive (you cannot clearly see over the raised hood, the hood latch has been damaged, etc.), you must have your vehicle transported.

⚠ WARNING: If the instrument panel displays an alert indicating that Active Hood has been deployed in situations where it has not, immediately drive Model S to the nearest Tesla Service Center.

NOTE: If damage occurs to the front bumper, contact a local Tesla-approved body shop to inspect the sensors for damage.



Displaying Trip Information

Trip information displays on the touchscreen when you touch **Controls** > **Trips**. For the current trip, you can display distance, duration and average energy usage. You can also show distance and total and average energy used since your last charge and for additional trips.

To name or rename a trip, touch the trip's name, enter a new name for the trip, then press **Save**. To reset a particular trip meter, touch its associated **Reset** button.

You can display information for up to three trips on the instrument panel. Use the checkboxes to specify the trip(s) you want to display. Then use the scroll bar on the steering wheel to display the chosen trip(s) (see [Using Left Steering Wheel Buttons on page 39](#) or [Using Right Steering Wheel Buttons on page 40](#)).

Odometer

To display the odometer, touch the Tesla “T” at the top center of the touchscreen.



Driving Tips to Maximize Range

You can maximize your driving range using the same driving habits you use to conserve fuel in a gasoline-powered vehicle. In addition to driving habits, energy consumption depends on environmental conditions (such as exceptionally cold or hot weather and driving on roads with steep hills). To achieve maximum range:

- Slow down your driving and avoid frequent and rapid acceleration. Consider using Chill Mode (see [Controls on page 117](#)) and Speed Assist (see [Speed Assist on page 115](#)) to assist in controlling your acceleration and speed.
- If safe to do so, modulate the accelerator pedal instead of using the brake pedal when gradually slowing down. Whenever Model S is moving and you are not pressing the accelerator pedal, regenerative braking slows down Model S and feeds surplus energy back to the Battery (see [Regenerative Braking on page 60](#)).
- Set Stopping Mode to **HOLD** to gain the benefit of regenerative braking at low driving speeds (see [Stopping Mode on page 60](#)).
- Keep tires at the recommended inflation pressures (see [Tire Care and Maintenance on page 162](#)), ensure tire alignment is within specification, and tires are rotated when needed. Rotating tires will reduce uneven tread wear, increasing your vehicle's efficiency (see [Maintenance Schedule on page 160](#)).
- Lighten your load by removing any unnecessary cargo.
- Fully raise all windows.
- Limit the use of resources such as heating, lights, and air conditioning. Using seat heaters to keep warm is more efficient than heating the cabin using climate controls.
- Precondition the vehicle while it is plugged in to ensure the cabin is at a comfortable temperature and windows are defrosted (if needed) before your drive. Use the mobile app to precondition your vehicle by touching **Climate > Turn On Climate** and customizing your preferences (see [Mobile App on page 150](#)).
- Turn on Range Mode, if equipped (see [Range Mode on page 72](#)).
- Features such as Sentry Mode, Headlights After Exit, and Cabin Overheat Protection can impact range. Disable features that are not needed.
- To prevent an excessive amount of energy consumption while the vehicle is idle, keep the vehicle plugged in when not in use.
- Minimize the use of DC chargers (such as superchargers) for optimal Battery health.

The power meter on the instrument panel and the Energy app (see [Energy App on page 71](#)) provides feedback on energy usage. With this feedback, you can become familiar with how driving habits and environmental conditions impact how much energy Model S is using.

Factors Affecting Energy Consumption

Several factors can affect your vehicle's rate of energy consumption, including:

- Uphill travel: Driving uphill requires more energy and depletes range at a faster rate. However, driving downhill allows your vehicle to regain a portion of its expended energy through regenerative braking (see [Regenerative Braking on page 60](#)).
- Customized settings: Energy is consumed by accessories like lights, heating and cooling, media player, Sentry Mode, etc.
- Short trips: It takes energy to bring the cabin and Battery to a specified temperature when starting the vehicle. You may see a higher average consumption when the vehicle is used for very short trips while climate controls are enabled.
- Temperature and weather conditions: In colder weather, precondition the vehicle before driving (see [Cold Weather Best Practices on page 77](#)).

When parked, Model S consumes approximately 1% of charge per day. In some cases (and depending on your vehicle's settings), consumption may be higher. To reduce energy consumption, turn off settings such as climate controls, Sentry Mode, Preconditioning (when your vehicle is unplugged), and any aftermarket equipment when not needed.

Range

The displayed range may decrease faster than the actual distance driven. When fully charged, the driving range displayed in Tesla vehicles is based on EPA certification and does not account for your personal driving patterns or external conditions. To view estimated range based on energy consumption, open the Energy app to display the graph.

As with all vehicles, the actual range achievable by Model S heavily depends on driving behaviors and environmental conditions.

Energy App

The Energy app provides a visual representation of your vehicle's real-time and projected energy usage. To use the Energy app, navigate to **Application Launcher > Energy** on the touchscreen. Choose from two types of charts:



Getting Maximum Range

- **Consumption:** Display how much energy Model S has consumed over the past 10, 25 or 50 km.

Touch **Instant Range** or **Average Range** to adjust the projected range estimation. Instant Range uses only the latest few data points to estimate the projected range, whereas Average Range uses the past 10, 25 or 50 km of energy consumption to provide a more accurate projected range.

- **Trip:** If your Model S is equipped with navigation, you can monitor the amount of energy being used while navigating to a destination. You can track actual usage against the initial prediction. The green line represents the actual usage whereas the gray line represents predicted usage. To change the zoom level, touch the zoom icon located in the top right corner of the chart.

NOTE: The Trip chart displays energy usage only if you are currently navigating to a destination.

Range Mode

Range Mode (if equipped) conserves energy by limiting the power of the climate control system and turns off the signature lights. Turn Range Mode on by touching **Controls > Driving > Range Mode**. When turned on in an All-Wheel Drive vehicle, Range Mode also optimizes torque distribution between the motors to maximize range.

Saving Energy

Model S has an energy-saving feature that reduces the amount of energy being consumed when Model S is not in use. On newer vehicles, this feature is automated to provide an optimal level of energy saving. However, on older vehicles, you can touch **Controls > Display > Energy Saving** and choose from the following options:

- **OFF** - Model S automatically shifts to the energy-saving mode only at night (10 pm to 5 am). Idle energy consumption may increase.
- **ON** - Significantly less energy is consumed whenever Model S is not in use. The start-up time of the instrument panel and Bluetooth could be slower.
- **Always Connected** - Preserves cellular connectivity when energy saving is active. This allows the mobile app to connect to Model S quicker, and provides immediate internet access when entering the car. Slightly more energy is consumed.

Range Assurance

Model S helps protect you against running out of energy. Your vehicle continuously monitors its energy level and proximity to known charging locations.



Touch the map's charging icon to toggle between displaying superchargers only, and displaying all chargers, including destination chargers, and visited chargers.

When you are at risk of driving beyond the range of known charging locations, the touchscreen displays a message giving you the opportunity to display a list of charging locations that are within range. When you select a charging location from the list, Model S provides navigation instructions and the turn-by-turn direction list displays the predicted amount of energy that will remain when you arrive at the charging destination.

Trip Planner (if equipped) routes you through Supercharger locations to minimize the amount of time you spend charging and driving. To enable, enter an address in the Navigation search bar, select the Settings icon, and toggle on Trip Planner (see [Trip Planner on page 131](#)).



Camera Location

Model S is equipped with a rear view camera located above the rear license plate.



Whenever you shift into Reverse, the touchscreen displays the view from the camera. Lines show your driving path based on the position of the steering wheel. These lines adjust appropriately as you move the steering wheel.

Model S also displays images from the side cameras. To view these images, simply swipe downward when the view from the rear view camera is displayed.

NOTE: You may need to expand the camera window to full page view to see the images from the side cameras.

NOTE: Visual feedback from the parking sensors also appear on the instrument panel (see [Park Assist on page 64](#)).

To display the view from the cameras at any time:



Open the app launcher then touch the camera icon.

WARNING: Never depend on the cameras to inform you if the area behind you is free of objects and/or people when reversing. The cameras may not detect objects or barriers that can potentially cause damage or injury. In addition, several external factors can reduce the performance of the cameras, including a dirty or obstructed lens. Therefore, depending on the cameras to determine if Model S is approaching an obstruction can result in damage to the vehicle and/or objects, and can potentially cause serious injury. Always inspect the area with your own eyes. When reversing, perform shoulder checks and use all mirrors. Use the cameras for guidance purposes only. It is not intended to replace your own direct visual checks and is not a substitute for careful driving.

Cleaning a Camera

To ensure a clear picture, the camera lens must be clean and free of obstructions. Remove any buildup of dirt by occasionally wiping the camera lens with a soft damp cloth.



CAUTION: Do not use chemical-based or abrasive cleaners. Doing so can damage the surface of the lens.

About Dashcam



NOTE: Dashcam is a BETA feature.

In addition to supporting Autopilot features, the cameras can record and store video footage of the surrounding roadway on a USB flash drive. This can be convenient in situations where you want a video recording of a particular incident, such as a collision. You can pause, resume, or save video recordings directly from your vehicle's touchscreen.

NOTE: Dashcam only works when Model S is powered on (see [Starting and Powering Off on page 44](#)). Dashcam does not record video when your vehicle is powered off.

Using Dashcam

Dashcam requires the use of a properly formatted USB flash drive to store and retrieve footage (see [USB Flash Drive Requirements for Videos and Recording on page 143](#)). Once a properly formatted USB flash drive has been inserted into one of your vehicle's front USB ports, a Dashcam icon appears at the top of the touchscreen. Touch the Dashcam icon to control Dashcam:

	<p>RECORDING. Tap the Dashcam icon, when Dashcam is paused, to start recording video on the flash drive.</p>
	<p>PAUSED. Press and hold the Dashcam icon, when recording, to pause recording. Ensure that Dashcam is paused before removing the flash drive to avoid losing camera footage.</p>
	<p>SAVED. Tap the Dashcam icon, when recording, to archive the most recent ten minutes of video. These saved video recordings are not overwritten by new recordings.</p>

NOTE: Dashcam automatically begins recording when you insert a properly configured USB flash drive into one of the front USB ports.

Retrieving Footage

If equipped, you can review Dashcam and Sentry Mode video recordings on your vehicle's touchscreen when Model S is in Park. Touch the Dashcam icon on the touchscreen's status bar and select **Launch Viewer**. Each video, organized by location and timestamp, provides a thumbnail of all video clips. For additional filtering, touch the **Dashcam** or **Sentry** tabs. Touch a thumbnail to view the corresponding video footage from each camera. Pause, rewind, fast forward, and delete video footage as needed.

You can retrieve video footage from the USB flash drive by removing the flash drive from the USB port and using a personal computer or other device to access the files. Navigate to the **TeslaCam** folder.

The **TeslaCam** folder contains three sub-folders:

- **Recent Clips** - The footage in Recent Clips continuously loops in 60-minute cycles whenever the cameras are activated. Therefore, footage is overwritten every hour unless you save it. When an event is recorded, one video is recorded for each of the front, rear (available on vehicles manufactured after approximately February 2018), left, and right cameras.
- **Saved Clips** - Contains all recordings that you have manually saved using Dashcam.
- **Sentry Clips** - Contains the last 10 minutes of footage from all Sentry Mode events that have triggered an Alert or Alarm state. The footage from each event is labelled with a unique timestamp.

NOTE: As the USB flash drive runs out of available space, the oldest footage in Sentry Clips is deleted to make room for new footage. Once deleted, you are unable to retrieve them. When the flash drive is full, Sentry Mode and Dashcam can no longer save video footage. To prevent the flash drive from getting full, you must regularly move saved videos to another device, and delete them from the flash drive.

NOTE: Dashcam recording is paused when the viewer is open.

NOTE: You are responsible for complying with all local laws, regulations, and property restrictions regarding video recordings.

NOTE: The cameras do not record audio.

USB Flash Drive Requirements for Videos and Recording

To store video from your vehicle's cameras, follow these requirements and guidelines for choosing, preparing, and using flash drives:

- The flash drive must have a **sustained** write speed of at least 4 MB/s. A sustained write speed is different from the peak write speed. Check the product details of your flash drive for more information.
- The flash drive must be USB 2.0 compatible. If using a USB 3.0 flash drive, it must be able to support USB 2.0.
- Use a flash drive with as much available storage as possible. Video footage can occupy a large amount of space. Tesla recommends using a flash drive with at least 32 GB of storage. Some personal computer operating systems may be unable to format flash

drives larger than 32 GB as FAT 32. Consider using a third party application to format flash drives larger than 32 GB.

- The flash drive must be properly formatted (described below).
- Use a dedicated flash drive exclusively for saving Sentry Mode recordings.

Although not a comprehensive list, Tesla has tested the following flash drives and confirmed that they meet the requirements for using Dashcam and Sentry Mode:

- SanDisk Ultra Fit USB 3.1 Flash Drive
- Samsung MUF-64AB/AM FIT Plus - 200MB/s USB 3.1 Flash Drive

Formatting a USB Flash Drive

To correctly save and retrieve video footage, Model S requires the USB flash drive to be formatted as exFAT, FAT 32 (for Windows), MS-DOS FAT (for Mac), ext3, or ext4. NTFS is currently not supported. In addition, the USB flash drive must contain a base-level folder called “TeslaCam” (without quotation marks).

You can format a USB flash drive from inside Model S or from a personal computer.

To format a flash drive from inside Model S, simply insert a USB flash drive into a front USB port, and touch **Safety & Security** > **FORMAT USB DEVICE**. Doing so formats the drive as exFAT and automatically creates a **TeslaCam** folder. The USB flash drive is now ready to record and save video footage.

 **CAUTION:** The **FORMAT USB DEVICE** button is available whenever a USB Flash Drive (with one or fewer partitions) is plugged into a front USB port. Choosing **FORMAT USB DEVICE** formats the drive, erasing all existing content. If you have content on a drive that you want to keep, you must move it to a different device before using this feature.

To format a USB flash drive from a personal computer, follow the steps below for your operating system.

For MacOS:

1. Insert the USB flash drive into your personal computer.
2. Navigate to **Utilities** > **Disk Utility** (or conduct a Spotlight Search).
3. Select your flash drive in the left menu.
4. Navigate to **Erase** in the top menu ribbon.
5. In the pop-up menu, select the correct format (MS-DOS FAT) and click **Erase**.

NOTE: Selecting **Erase** removes all existing content from your flash drive. If you have content that you want to keep, you must move it to a different device before erasing.

6. Once the flash drive is successfully erased, navigate to **Finder** and select your USB flash drive from the left menu. The flash drive should not contain any files.
7. Right-click in the empty space of the flash drive and select **New Folder**. A folder appears in your flash drive space.
8. Right-click on the folder, select **Rename**, and name the folder to “**TeslaCam**” (without quotation marks). Click “Save”. This folder will contain all recent and saved clips from Sentry Mode and Dashcam.
9. Properly eject the USB flash drive.

For Windows:

1. Insert the USB flash drive into your personal computer.
 2. Navigate to **File Explorer**.
 3. Right-click on your USB flash drive and select “Format...”.
 4. In the pop-up menu, under the File System section, select a support format (such as exFAT, FAT 32, etc.)
- NOTE:** You can also name your USB flash drive (under Volume Label).
5. Check the **Quick format** box and click **Start**.
 6. Go back to File Explorer, click on your flash drive, and right-click to create a folder, or select **New Folder** in the top menu.
 7. Name the folder “**TeslaCam**” (without quotation marks) and click **Save**. This folder will contain all recent and saved clips from Sentry Mode and Dashcam.
 8. Properly eject the USB flash drive.

Once you have formatted the USB flash drive and created the **TeslaCam** folder, insert it into a USB port in Model S. Do not use the rear USB ports—they are for charging only. It may take Model S up to 15 seconds to recognize the flash drive. When recognized, icons for Dashcam and Sentry Mode appear at the top of your touchscreen (note that you may need to enable Sentry Mode by touching **Controls** > **Safety & Security** > **Sentry Mode**). Model S is ready to record video.

Save Clips on Honk

Once a properly formatted USB flash drive is inserted in one of the vehicle’s front USB ports, you can choose to save Dashcam clips while driving when you honk the horn on your steering wheel. Navigate to **Controls** > **Safety and Security** > **Save Clips on Honk** > **ON** to



Dashcam

enable. The most recent ten minutes of footage is saved. You can also save Dashcam footage by touching the Dashcam icon at the top of the touchscreen.



To ensure that Model S provides you with the best ownership experience possible in harsh cold weather conditions, follow these best practices.

Before Driving

When snow and ice accumulate on your vehicle, moving parts, such as the door handles, windows, mirrors, and wipers can freeze in place. For these reasons, and to achieve maximum range and performance, it is helpful to warm the cabin and Battery before you leave. There are several ways to do so:

- **Scheduled Departure:** Set the time when you want your vehicle to be ready to drive (see [Scheduled Charging and Scheduled Departure on page 158](#)).
- On the mobile app, navigate to **Climate > Turn On Climate** and set to **HI** (or customize the temperature at which you want to heat the cabin). The Battery also warms as needed.
- On the mobile app, navigate to **Climate > Defrost** to melt snow, ice, and frost on the windshield, driver and passenger windows, mirrors. The Battery also warms as needed.

NOTE: Tesla recommends activating climate settings at least 30-45 minutes before departure (see [Climate Controls on page 123](#)). Preconditioning times depend on outside temperature and other factors.

NOTE: In extremely cold weather or icy conditions, it is possible that your charge port latch may freeze in place. In cases where you cannot remove or insert the charge cable, or the vehicle is not Supercharging due to the latch being frozen in place, use your Tesla mobile app to precondition your vehicle on **HI** for approximately 30-45 minutes (you must use your mobile app to precondition the vehicle; setting your climate to **HI** using the touchscreen will not be effective). This can help thaw ice on the charge port latch so the charge cable can be removed or inserted.

NOTE: Tesla recommends activating climate settings at least 30-45 minutes before departure (see [Climate Controls on page 123](#)). Preconditioning times depend on outside temperature and other factors.

Windows

- On the mobile app, navigate to **Climate > Defrost** as mentioned previously.
- Use the mobile app to schedule a service appointment for Tesla to provide hydrophobic coating to your windows for a nominal fee.

Mirrors

If ice buildup is expected when parking, turn off **Auto-Fold Mirrors** by navigating to **Controls > Vehicle > Mirror Auto-Fold > ON**. Ice can prevent exterior side mirrors from folding or unfolding.

NOTE: Side mirrors automatically heat as needed during preconditioning, or when the rear defroster is turned on.

Wipers

If you expect snow or ice to build up when parked, navigate to **Controls > Service > Wiper Service Mode > ON**. This raises wipers against the windshield so they can defrost when the windshield defrosts (see [Wipers and Washers on page 58](#)).

Winter Tires and Tire Chains

- Use winter tires to increase traction in snowy or icy conditions. You can purchase winter tires on <http://www.tesla.com> (see [Seasonal Tire Types on page 165](#)).
- Tire chains provide additional traction when driving in snowy or icy conditions. Check local regulations to determine if tire chains are recommended or required during winter months. See [Using Tire Chains on page 166](#) for more information.

While Driving

Cold weather can increase energy consumption because more power is required for driving, cabin and Battery heating. Follow these suggestions to reduce energy consumption:

- Use seat heaters to keep warm. Seat heaters use less energy than the cabin heater. Lowering the cabin temperature and using seat heaters will reduce energy consumption (see [Climate Controls on page 123](#)).
- Slow down your driving and avoid frequent and rapid acceleration.
- Turn on Range Mode (if equipped) to automatically limit the power that the climate control system uses to maintain the temperature of the Battery and the cabin area. Range Mode also turns off signature lights (if equipped) and adjusts the front and rear motor torque split to maximize range (see [Getting Maximum Range on page 71](#)).

Regenerative Braking

Regenerative braking can be limited if the Battery is too cold. As you continue to drive, the Battery warms up and regenerative power increases (see [Regenerative Braking on page 60](#)).



Cold Weather Best Practices

NOTE: Limited regenerative braking can be avoided if you allow enough time to precondition your vehicle or use scheduled departure before your drive, as mentioned previously.

Blue Snowflake Icon



A blue snowflake icon appears on your instrument panel when some of the stored energy in the Battery is unavailable because the Battery is cold. This portion of unavailable energy displays in blue on the Battery meter. Regenerative braking, acceleration, and charging rates may be limited. The snowflake icon no longer displays when the Battery is sufficiently warmed.

Warming the Battery Before Supercharging

By using Trip Planner (see [Trip Planner on page 131](#)) to navigate to a Supercharger, Model S pre-heats the Battery to ensure when you arrive at the Supercharger, the Battery temperature is optimal and ready to charge. This reduces the amount of time it takes to charge.

Autopilot

To ensure optimal Autopilot performance, keep the sensors and radar free of snow, ice, mud, and dirt (see [About Autopilot on page 79](#)).

After Driving

Leave Model S plugged in when not in use. This uses the charging system, rather than the Battery itself, to keep the Battery warm (see [Battery Information on page 154](#)).

Scheduled Departure

When parked, plug in Model S and set a time when you want your vehicle to be ready to drive. Your vehicle determines the appropriate time to begin charging so that charging is complete and the cabin and Battery are warm by your set departure time. For more information, see [Scheduled Charging and Scheduled Departure on page 158](#).

Charge Port

- If your charge port latch freezes in place and a charging cable becomes stuck in the charge port, try manually releasing the charge cable. See [Manually Releasing Charge Cable on page 156](#).

- Use the mobile app to precondition your vehicle on **HI** to help thaw ice on the charge port latch so that the charge cable can be removed or inserted (see [Mobile App on page 150](#)).

NOTE: If your charge port latch is frozen in place, it may not lock the charging cable in place when inserted, but it can still charge at a slow AC rate even if the latch is not engaged.

Storage

If you leave Model S parked for an extended period of time, plug it into a charger to prevent normal range loss and to keep the Battery at an optimal temperature. Your vehicle is safe to stay plugged in for any length of time.

When not in use, Model S enters a sleep mode to conserve energy. Reduce the number of times you check your vehicle's status on the mobile app, as this automatically wakes up your vehicle and starts normal energy consumption.



How It Works

Your Model S includes the following Autopilot components that actively monitor the surrounding roadway:

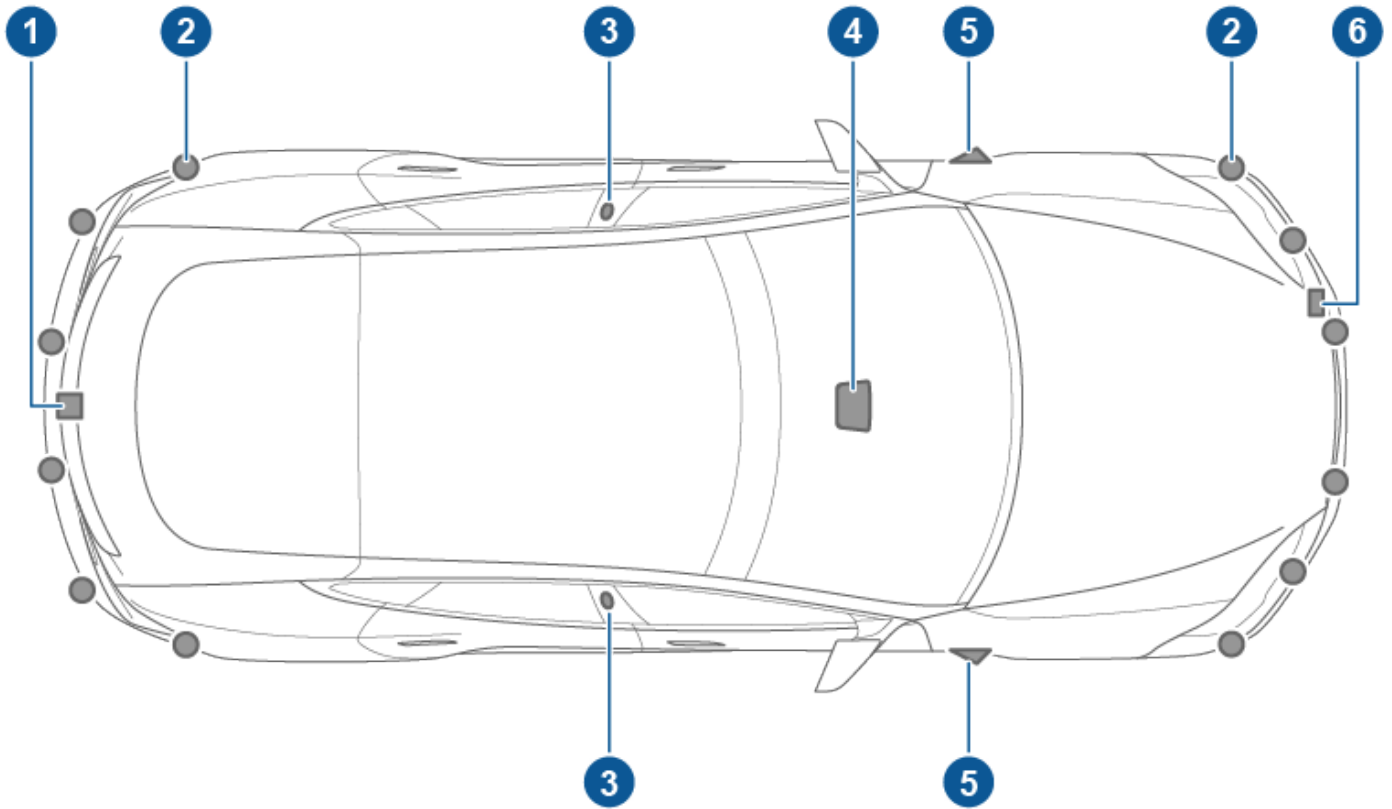

1. A camera is mounted above the rear license plate.
2. Ultrasonic sensors are located in the front and rear bumpers.
3. A camera is mounted in each door pillar.
4. Three cameras are mounted to the windshield above the rear view mirror.
5. A camera is mounted to each front fender.
6. Radar is mounted behind the front bumper.

Model S is also equipped with high precision electronically-assisted braking and steering systems.

NOTE: Ensure all cameras and sensors are clean before each drive. See [Cleaning Cameras and Sensors](#) on page 81 for more information. Unclean cameras and sensors, as well as environmental conditions such as rain and faded lane markings, can affect Autopilot performance.

Features

These safety features are available on all Model S equipped with Autopilot components:

- Lane Assist (see [Lane Assist on page 109](#)).
- Collision Avoidance Assist (see [Collision Avoidance Assist on page 112](#)).
- Speed Assist (see [Speed Assist on page 115](#)).
- Auto High Beam (see [High Beam Headlights on page 50](#)).

These Autopilot convenience features are designed to reduce driver workload:

- Traffic-Aware Cruise Control (see [Traffic-Aware Cruise Control on page 82](#))
- Autosteer (see [Autosteer on page 87](#))
- Auto Lane Change (see [Auto Lane Change on page 89](#))
- Autopark (see [Autopark on page 101](#))
- Summon (see [Summon on page 103](#))
- Smart Summon ([Smart Summon on page 106](#))
- Navigate on Autopilot (see [Navigate on Autopilot on page 91](#))
- Stop Light and Stop Sign Warning (see [Stop Light and Stop Sign Warning on page 89](#))
- Traffic Light and Stop Sign Control (see [Traffic Light and Stop Sign Control on page 94](#)).

NOTE: Depending on market region, vehicle configuration, options purchased, and software version, your vehicle may not be equipped with all Autopilot features.

You can enable/disable some of these features and in some cases, control how they work. To access settings, touch **Controls > Autopilot**.

Drive to Calibrate Cameras

Model S must maneuver with a great deal of precision when Autopilot features are being used. Therefore, before some features (for example, Traffic-Aware Cruise Control or Autosteer) can be used for the first time or after certain Service repairs, the cameras must complete a self-calibration process. For your convenience, a progress indicator is displayed on the instrument panel.

Calibration typically completes after driving 32-40 km, but the distance varies depending on road and environmental conditions. Driving on a straight road with highly-visible lane lines allows Model S to calibrate quicker. When calibration is complete, the Autopilot features are available for use. Contact Tesla only if your Model S has not completed the calibration process after driving 160 km.

NOTE: If you attempt to use a feature that is not available until the calibration process is complete, the feature will not be enabled and the instrument panel displays a message.

NOTE: Model S must repeat the calibration process if the cameras are serviced by Tesla, and in some cases, after a software update.

NOTE: The self-calibration drive process is only applicable to Model S vehicles built after approximately October 12, 2016.

NOTE: If the cameras have moved out of their calibrated position (for example, due to a camera or windshield replacement), the calibration can be cleared by touching **Controls > Service > Camera Calibration > Clear Calibration**. Once the calibration has been cleared, the self-driving calibration drive must be performed again.

Limitations

Many factors can impact the performance of Autopilot components, causing them to be unable to function as intended. These include (but are not limited to):

- Poor visibility (due to heavy rain, snow, fog, etc.).
- Bright light (due to oncoming headlights, direct sunlight, etc.).
- Damage or obstructions caused by mud, ice, snow, etc.
- Interference or obstruction by object(s) mounted onto the vehicle (such as a bike rack).
- Obstruction caused by applying excessive paint or adhesive products (such as wraps, stickers, rubber coating, etc.) onto the vehicle.
- Narrow or winding roads.
- A damaged or misaligned bumper.
- Interference from other equipment that generates ultrasonic waves.
- Extremely hot or cold temperatures.



WARNING: The list above does not represent an exhaustive list of situations that may interfere with proper operation of Autopilot components. Never depend on these components to keep you safe. It is the driver's responsibility to stay alert, drive safely, and be in control of the vehicle at all times.





CAUTION: If a windshield replacement is needed, take your vehicle to Tesla Service. This will ensure appropriate handling and mounting of the camera(s). Failure to do so can cause one or more Autopilot features to malfunction.



Cleaning Cameras and Sensors

To ensure the various Autopilot components can provide information that is as accurate as possible, keep them clean and free of obstructions, condensation, or damage. Occasionally remove any buildup of dirt by wiping the components with a soft cloth dampened with warm water.

Condensation can form inside the camera enclosures, especially if you park your vehicle outside in cold or wet conditions. The instrument cluster may display an alert stating that a camera is blocked and that some or all Autopilot features may be temporarily restricted until the camera vision is clear. To proactively dry the condensation, precondition the cabin by setting it to a warm temperature, turning the windshield defroster on, and directing the front air vents toward the door pillars (see [Mobile App on page 150](#)).

-  **CAUTION:** Do not use chemical-based or abrasive cleaners. Doing so can damage surfaces.
-  **CAUTION:** Avoid using a high-pressure power washer.
-  **CAUTION:** Do not clean an ultrasonic sensor or camera lens with a sharp or abrasive object that can scratch or damage its surface.



Traffic-Aware Cruise Control

NOTE: Depending on market region, vehicle configuration, options purchased, and software version, your vehicle may not be equipped with Traffic-Aware Cruise Control. If your vehicle is not equipped, refer to the owner's manual on your vehicle's touchscreen for instructions on how to use Cruise Control.

NOTE: Traffic-Aware Cruise Control is a BETA feature.

Traffic-Aware Cruise Control (if equipped) uses the forward looking cameras and the radar sensor to determine when there is a vehicle in front of you in the same lane. If the area in front of Model S is clear, Traffic-Aware Cruise Control maintains a set driving speed. When a vehicle is detected, Traffic-Aware Cruise Control is designed to slow down Model S as needed to maintain a selected time-based distance from the vehicle in front, up to the set speed. Traffic-Aware Cruise Control does not eliminate the need to watch the road in front of you and to manually apply the brakes when needed.

Traffic-Aware Cruise Control is primarily intended for driving on dry, straight roads, such as highways and freeways. It should not be used on city streets.

CAUTION: Ensure all cameras and sensors are clean before each drive. Unclean cameras and sensors, as well as environmental conditions such as rain and faded lane markings, can affect Autopilot performance.

WARNING: Traffic-Aware Cruise Control is designed for your driving comfort and convenience and is not a collision warning or avoidance system. It is your responsibility to stay alert, drive safely, and be in control of the vehicle at all times. Never depend on Traffic-Aware Cruise Control to adequately slow down Model S. Always watch the road in front of you and be prepared to take corrective action at all times. Failure to do so can result in serious injury or death.

WARNING: Although Traffic-Aware Cruise Control is capable of detecting pedestrians and cyclists, never depend on Traffic-Aware Cruise Control to adequately slow Model S down for them. Always watch the road in front of you and be prepared to take corrective action at all times. Failure to do so can result in serious injury or death.

WARNING: Do not use Traffic-Aware Cruise Control on city streets or on roads where traffic conditions are constantly changing.

WARNING: Do not use Traffic-Aware Cruise Control on winding roads with sharp curves, on icy or slippery road surfaces, or when weather conditions (such as heavy rain, snow, fog, etc.) make it inappropriate to drive at a consistent speed. Traffic-Aware Cruise Control does not adapt driving speed based on road and driving conditions.

To Use Traffic-Aware Cruise Control

To initiate Traffic-Aware Cruise Control when no vehicle is detected ahead of you, you must be driving at least 30 km/h, unless certain vehicle and environmental conditions are met, in which case, you may be able to initiate it at lower speeds. If a vehicle is detected ahead of you, you can initiate Traffic-Aware Cruise Control at any speed, even when stationary, provided Model S is at least 150 cm behind the detected vehicle.

NOTE: The maximum cruising speed is 150 km/h. It is the driver's responsibility to cruise at a safe speed based on road conditions and speed limits.

	When Traffic-Aware Cruise Control is available but not engaged and cruising at a specified set speed, the instrument panel displays a gray speedometer icon next to your current driving speed. The number shown in gray represents the cruising speed that will be set when you engage Traffic-Aware Cruise Control.
	When Traffic-Aware Cruise Control is actively cruising at a set cruising speed, the icon turns blue and displays the cruising speed.

To engage Traffic-Aware Cruise Control to cruise *at your current driving speed* (provided you are driving within the minimum and maximum speed parameters described above), move the Autopilot stalk up or down.

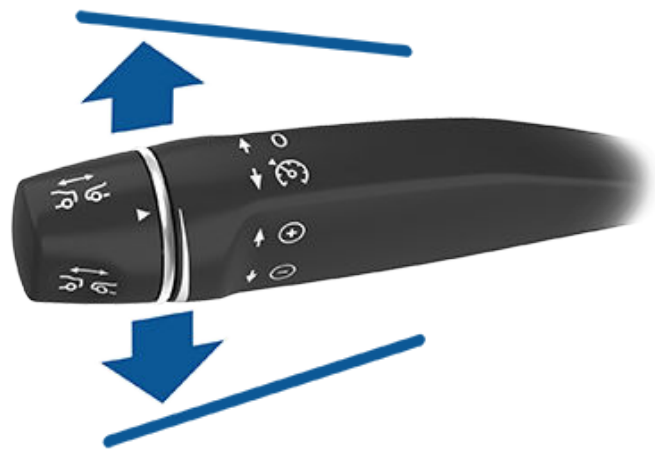

To engage Traffic-Aware Cruise Control to cruise *at the currently detected speed limit*, pull the Autopilot stalk toward you. To specify an offset of the speed limit, touch **Controls > Autopilot > Set Speed Offset**. You can choose a **FIXED** offset, in which the cruising speed adjusts by a specific number of km/h on all roads, or a **PERCENTAGE** offset, in which the cruising speed is adjusted as a percentage of the road's detected speed limit. If you pull the Autopilot stalk toward you when you are already driving faster than the speed limit, the set



speed adjusts to your current driving speed instead of the speed limit. If you move the Autopilot stalk up or down when cruising at the speed limit, your set speed changes to your current driving speed.

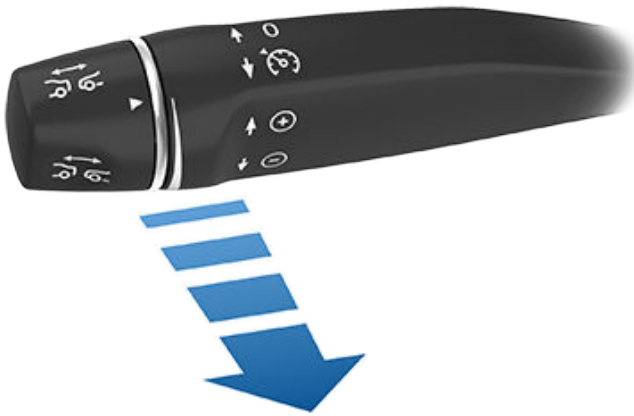

After setting the cruising speed, release the accelerator pedal to allow Traffic-Aware Cruise Control to maintain the cruising speed.

NOTE: Double-pulling the Autopilot stalk toward you engages Autosteer (assuming it has been enabled as described in [Autosteer on page 87](#)) in addition to setting the cruising speed.

⚠ WARNING: When you adjust the cruising speed based on the speed limit, the set cruising speed may not change when the speed limit changes. You must pull the Autopilot stalk again to cruise at the new speed limit. You can also manually adjust your cruising speed at any time (see [Changing the Cruising Speed on page 83](#)).

⚠ WARNING: Do not rely on Traffic-Aware Cruise Control or Speed Assist to determine an accurate or appropriate cruising speed. It is the driver's responsibility to cruise at a safe speed based on road conditions and applicable speed limits.

Changing the Cruising Speed

To change the set cruising speed while using Traffic-Aware Cruise Control, move the Autopilot stalk up (increase) or down (decrease) until the instrument panel icon displays your desired cruising speed.

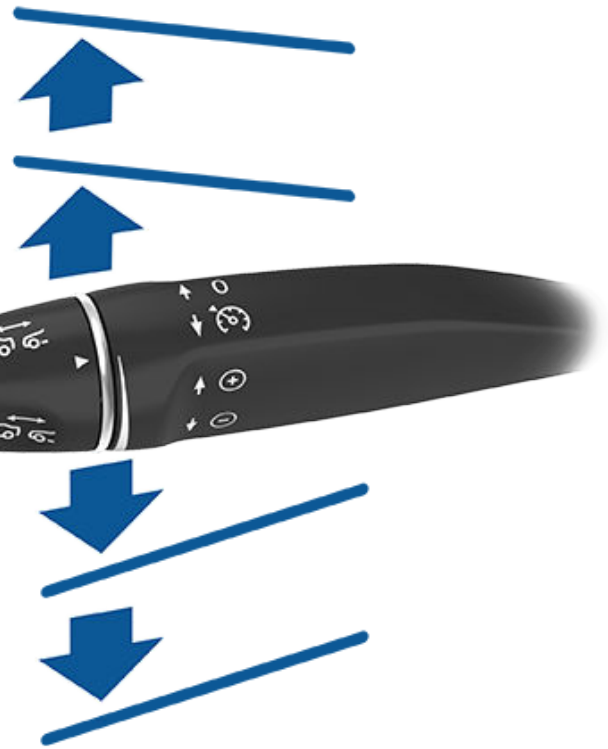

To increase/decrease speed by 1 km/h, move the stalk up or down to the first position and release. To increase/decrease speed to the closest 5 km/h increment, move the stalk up/down to the second position and release. For example, if you are traveling at 83 km/h and you move the stalk up to the second position and release, the speed increases to 85 km/h. You can also increase/decrease speed by holding the stalk in the full up/down position and releasing when the icon on the instrument panel displays your desired cruising speed.

NOTE: It may take a few seconds for Model S to reach the new cruising speed, assuming Model S is not cruising behind a vehicle that is driving slower than your set speed.

Cruising at the Set Speed

Traffic-Aware Cruise Control maintains your set cruising speed whenever a vehicle is not detected in front of Model S. When cruising behind a detected vehicle, Traffic-Aware Cruise Control accelerates and decelerates Model S as needed to maintain a chosen following distance (see [Adjust the Following Distance on page 84](#)), up to the set speed.

Traffic-Aware Cruise Control also adjusts the cruising speed when entering and exiting curves.

You can manually accelerate at any time when cruising at a set speed, but when you release the accelerator, Traffic-Aware Cruise Control resumes cruising at the set speed.



Traffic-Aware Cruise Control

NOTE: When Traffic-Aware Cruise Control is actively slowing down Model S to maintain the selected distance from the vehicle ahead, brake lights turn on to alert other road users that you are slowing down. You may notice slight movement of the brake pedal. However, when Traffic-Aware Cruise Control is accelerating Model S, the accelerator pedal does not move.

⚠ WARNING: Traffic-Aware Cruise Control may occasionally cause Model S to brake when not required or when you are not expecting it. This can be caused by closely following a vehicle ahead, detecting vehicles or objects in adjacent lanes (especially on curves), etc.

⚠ WARNING: Due to limitations inherent in the onboard GPS (Global Positioning System), you may experience situations in which Traffic-Aware Cruise Control slows down the vehicle, especially near highway exits where a curve is detected and/or you are actively navigating to a destination and not following the route.

⚠ WARNING: Traffic-Aware Cruise Control cannot detect all objects and, especially in situations when you are driving over 80 km/h, may not brake/decelerate when a vehicle or object is only partially in the driving lane or when a vehicle you are following moves out of your driving path and a stationary or slow-moving vehicle or object is in front of you. Always pay attention to the road ahead and stay prepared to take immediate corrective action. Depending on Traffic-Aware Cruise Control to avoid a collision can result in serious injury or death. In addition, Traffic-Aware Cruise Control may react to vehicles or objects that either do not exist or are not in the lane of travel, causing Model S to slow down unnecessarily or inappropriately.

⚠ WARNING: Traffic-Aware Cruise Control may be unable to provide adequate speed control because of limited braking capability and hills. It can also misjudge the distance from a vehicle ahead. Driving downhill can increase driving speed, causing Model S to exceed your set speed (and potentially the road's speed limit). Never depend on Traffic-Aware Cruise Control to slow down the vehicle enough to prevent a collision. Always keep your eyes on the road when driving and be prepared to take corrective action as needed. Depending on Traffic-Aware Cruise Control to slow the vehicle down enough to prevent a collision can result in serious injury or death.

HOLD State

When following a vehicle, Traffic-Aware Cruise Control remains active at low speeds, even when Model S comes to a full stop. When the vehicle is moving again, Traffic-Aware Cruise Control resumes operating at the set speed. However, under the following circumstances, Traffic-Aware Cruise Control goes into a **HOLD** state, in

which case, you need to briefly press the accelerator pedal or pull the Autopilot stalk toward you (see [Canceling and Resuming on page 85](#)) to resume cruising. When the **HOLD** status is active, the instrument panel displays the **HOLD** icon and a message that indicates that you need to resume cruise control. The following circumstances can cause Traffic-Aware Cruise Control to go into the **HOLD** state:

- Model S has been at a standstill for 5 minutes.
- Model S detects a pedestrian (the **HOLD** state may clear when the pedestrian is no longer detected).
- Model S suddenly loses visibility of the vehicle in front of you.
- The ultrasonic sensors detect an obstacle in front of Model S.

Cruising Near or On Freeway Exits

When cruising near an exit on a controlled access road (such as a highway or freeway) and engaging the turn signal toward the exit, Traffic-Aware Cruise Control assumes you are exiting and begins to slow down the vehicle. If you do not drive onto the exit, Traffic-Aware Cruise Control resumes cruising at the set speed. In a region with right hand traffic, this occurs only when you engage the right turn signal when driving in the right-most lane within 50 meters of an exit. Likewise in regions with left hand traffic; when engaging the left turn signal when driving in the left-most lane within 50 meters of an exit.

When cruising onto an on-ramp to a controlled access road (such as a highway or freeway), Traffic-Aware Cruise Control automatically adjusts the set cruising speed to the speed limit of the highway, plus any offset you have specified (see [Speed Assist on page 115](#)).

NOTE: The onboard Global Positioning System (GPS) determines if you are driving in a region with right or left hand traffic. In situations where GPS data is unavailable (for example, if there is inadequate signal), engaging the turn signal near an exit does not cause Traffic-Aware Cruise Control to slow down Model S.

Adjust the Following Distance

To adjust the following distance you want to maintain between Model S and a vehicle traveling ahead of you, rotate the Autopilot stalk to choose a setting from 1 (the closest following distance) to 7 (the longest following distance). Each setting corresponds to a time-based distance that represents how long it takes for Model S, from its current location, to reach the location of the rear bumper of the vehicle ahead of you.



As you rotate the Autopilot stalk, the instrument panel displays the current setting. Release the stalk when the desired setting is displayed.



NOTE: Your setting is retained until you manually change it.

- ⚠ WARNING:** It is the driver's responsibility to determine and maintain a safe following distance at all times. Do not rely on Traffic-Aware Cruise Control to maintain an accurate or appropriate following distance.
- ⚠ WARNING:** Never depend on Traffic-Aware Cruise Control to adequately slow down Model S to avoid a collision. Always watch the road in front of you and stay prepared to take immediate corrective action.

Overtake Acceleration

When following a vehicle with Traffic-Aware Cruise Control active, briefly engaging the turn signal (to indicate a move into the passing lane) accelerates Model S towards the vehicle ahead. By momentarily holding the turn signal stalk up or down, you can quickly accelerate up to your set speed without having to press the accelerator pedal. The turn signal causes acceleration only when all of the following conditions are met:

- Traffic-Aware Cruise Control is operating and detects a vehicle in front of you.
- No obstacles or vehicles are detected in the target lane.
- Model S is traveling below the set speed, but over 72 km/h.

Overtake Acceleration is intended as an aid when passing a vehicle ahead of you. When the turn signal is engaged, Traffic-Aware Cruise Control continues to maintain distance from the vehicle ahead, but allows you to drive slightly closer than your selected distance.

Acceleration cancels when one of the conditions happen:

- You reach your set cruising speed.
- Changing lanes takes too long.
- Model S gets too close to the vehicle ahead.

OR

- You disengage the turn signal.

NOTE: Overtake Acceleration occurs when you either fully engage the turn signal, or you hold the turn signal in the momentary position (partially engaged). When you release or disengage the turn signal, Model S stops accelerating (in the same way as when you release the accelerator pedal) and resumes the set speed.

- ⚠ WARNING:** Overtake Acceleration can cancel for many unforeseen reasons in addition to those listed above (for example, lack of GPS data). Stay alert and never depend on Overtake Acceleration to increase your driving speed.
- ⚠ WARNING:** Overtake Acceleration increases your driving speed whenever the appropriate turn signal is engaged, and accelerates Model S closer to the vehicle ahead. Although Traffic-Aware Cruise Control continues to maintain distance from the vehicle ahead, it is important to be aware that your selected following distance is reduced when Overtake Acceleration is active, particularly in cases where it may not be your intention to overtake the vehicle you are following.

Canceling and Resuming

To manually cancel Traffic-Aware Cruise Control, briefly push the Autopilot stalk away from you or press the brake pedal. The speedometer icon on the instrument panel turns gray to indicate that Traffic-Aware Cruise Control is no longer active.



To resume cruising at the previously set speed, briefly pull the Autopilot stalk toward you.



Traffic-Aware Cruise Control

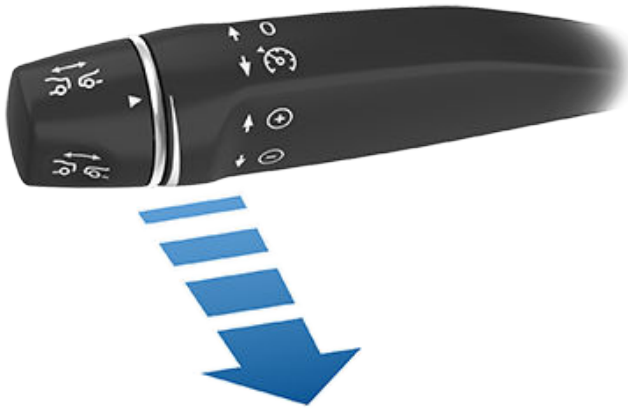

To resume cruising at the current driving speed, move the Autopilot stalk up or down, then release.

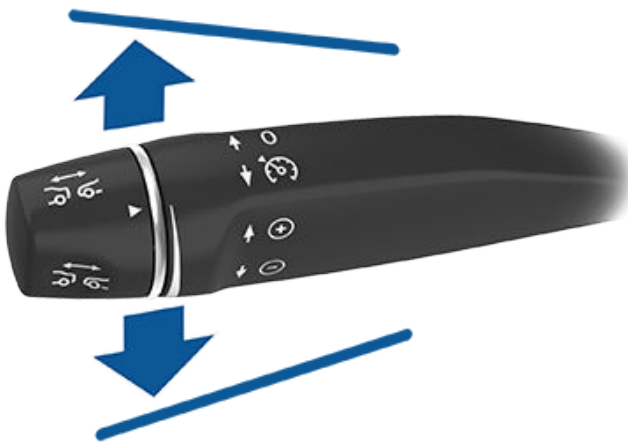

NOTE: When Traffic-Aware Cruise Control cancels, Model S does not coast. Instead, regenerative braking slows down Model S in the same way as when you move your foot off the accelerator when driving without Traffic-Aware Cruise Control (see [Regenerative Braking on page 60](#)).

WARNING: Traffic-Aware Cruise Control cancels, or may not be available, in the following situations:

- You press the brake pedal.
- Your driving speed exceeds the maximum cruising speed of 150 km/h.
- You shift Model S into a different gear.
- A door is opened.
- The view from the radar sensor or camera(s) is obstructed. This could be caused by dirt, mud, ice, snow, fog, etc.
- The traction control setting is manually disabled or is repeatedly engaging to prevent wheels from slipping.
- The wheels are spinning while at a standstill.
- The Traffic-Aware Cruise Control system is failing or requires service.

When Traffic-Aware Cruise Control is unavailable or cancels, Model S no longer drives consistently at a set speed and no longer maintains a specified distance from the vehicle ahead.

WARNING: Traffic-Aware Cruise Control can cancel unexpectedly at any time for unforeseen reasons. Always watch the road in front of you and stay prepared to take appropriate action. It is the driver's responsibility to be in control of Model S at all times.

Summary of Cruise Indicators

	Traffic-Aware Cruise Control is available but is not actively controlling your speed until you activate it. The number shown in gray is determined by Speed Assist (see Controlling Speed Assist on page 115).
	Traffic-Aware Cruise Control is operating and is either maintaining the set speed (no vehicle in front) or is maintaining a chosen following distance from a vehicle ahead (up to the set speed).
	Model S has fully stopped but is in a HOLD state. If safe, press the accelerator pedal to resume cruising at the set speed.

Limitations

Traffic-Aware Cruise Control is particularly unlikely to operate as intended in the following types of situations:

- The road has sharp curves.
- Visibility is poor (due to heavy rain, snow, fog, etc.).
- Bright light (such as from oncoming headlights or direct sunlight) is interfering with the view of the camera(s).
- The radar sensor is obstructed (dirty, covered, etc.).
- The windshield is obstructing the view of the camera(s) (fogged over, dirty, covered by a sticker, etc.).



WARNING: The list above does not represent an exhaustive list of situations that may interfere with proper operation of Traffic-Aware Cruise Control.

NOTE: Depending on market region, vehicle configuration, options purchased, and software version, your vehicle may not be equipped with Autosteer.

NOTE: Autosteer is a BETA feature.

Autosteer builds upon Traffic-Aware Cruise Control (see [Traffic-Aware Cruise Control on page 82](#)), intelligently keeping Model S in its driving lane when cruising at a set speed. Autosteer also allows you to use the turn signals to move Model S into an adjacent lane (see [Auto Lane Change on page 89](#)). Using the vehicle's camera(s), the radar sensor, and the ultrasonic sensors, Autosteer detects lane markings and the presence of vehicles and objects to assist you in steering Model S.

NOTE: Touch Controls > Autopilot > Full Self-Driving Visualization Preview (if equipped) to display more details about the roadway and its surroundings, such as road markings, stop lights, objects (such as trash cans and poles), etc.

-  **CAUTION:** Ensure all cameras and sensors are clean. Unclean cameras and sensors, as well as environmental conditions such as rain and faded lane markings, can affect Autopilot performance.
-  **WARNING:** Autosteer is a hands-on feature. You must keep your hands on the steering wheel at all times.
-  **WARNING:** Autosteer is intended for use only on highways and limited-access roads with a fully attentive driver. When using Autosteer, hold the steering wheel and be mindful of road conditions and surrounding traffic. Do not use Autosteer on city streets, in construction zones, or in areas where bicyclists or pedestrians may be present. Never depend on Autosteer to determine an appropriate driving path. Always be prepared to take immediate action. Failure to follow these instructions could cause damage, serious injury or death.

Operating Autosteer

Before you can operate Autosteer, you must enable it by touching **Controls > Autopilot > Autosteer (Beta)**.

	<p>To indicate that Autosteer is available (but not actively steering Model S), the instrument panel displays a gray Autosteer icon on the right side of the driving speed.</p>
---	---

To initiate Autosteer, pull the Autopilot stalk toward you twice in quick succession.

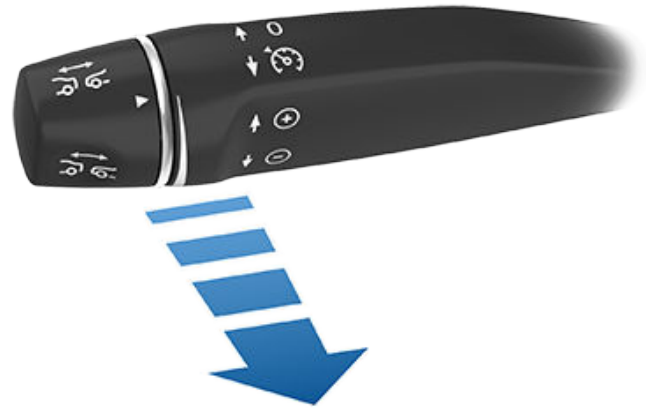

Autosteer briefly displays a message on the instrument panel reminding you to pay attention to the road and have your hands on the steering wheel. To indicate that Autosteer is now actively assisting in steering Model S, the instrument panel displays the Autosteer icon in blue. When Autosteer is able to detect lane markings, it also displays the driving lane in blue.



To initiate Autosteer when no vehicle is detected ahead of you, you must be driving at least 30 km/h, unless certain vehicle and environmental conditions are met, in which case, you may be able to initiate it at lower speeds. If a vehicle is detected ahead of you, you can initiate Autosteer at any speed, even when stationary, provided Model S is at least 150 cm behind the detected vehicle.

NOTE: The maximum cruising speed is 150 km/h. It is the driver's responsibility to cruise at a safe speed based on road conditions and speed limits.

The instrument panel displays a message indicating that Autosteer is temporarily unavailable if you attempted to engage Autosteer when driving at a speed that is not within the speed required for Autosteer to operate. Autosteer may also be unavailable if it is not receiving adequate data from the camera(s) or sensors.

If Autosteer is unable to detect lane markings, the driving lane is determined based on the vehicle you are following.

In most cases, Autosteer attempts to center Model S in the driving lane. However, if the sensors detect the presence of an obstacle (such as a vehicle or guard rail), Autosteer may steer Model S in a driving path that is offset from the center of the lane.

 **WARNING:** Autosteer is not designed to, and will not, steer Model S around objects partially or completely in the driving lane. Always watch the road in front of you and stay prepared to take appropriate action. It is the driver's responsibility to be in control of Model S at all times.

Restricted Speed

Autosteer is intended for use only by a fully attentive driver on freeways and highways where access is limited by entry and exit ramps. If you choose to use Autosteer on residential roads, a road without a center divider, or a road where access is not limited, Autosteer may limit the maximum allowed cruising speed and the instrument panel displays a message indicating that speed is restricted. The restricted speed will be the speed limit of the road plus 10 km/h.

In situations where the speed limit cannot be detected when Autosteer is engaged, Autosteer reduces your driving speed and limits the set cruising speed to 70 km/h. Although you can manually accelerate to exceed the limited speed, Model S may not brake for detected obstacles. Autosteer slows down to the limited speed when you release the accelerator pedal. When you leave the road, or disengage Autosteer by using the steering wheel, you can increase your set speed again, if desired.

Hold Steering Wheel

Autosteer uses data from the camera(s), sensors, and GPS to determine how best to assist you in steering Model S. When active, Autosteer requires you to hold the steering wheel. If it does not detect your hands on the steering wheel for a period of time, a flashing white light appears along the top of the instrument panel and the following message displays:

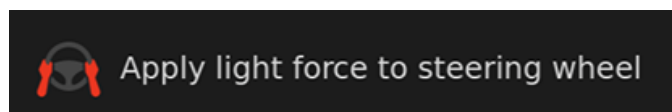

Autosteer detects your hands by recognizing light resistance as the steering wheel turns, or from you manually turning the steering wheel very lightly (without enough force to retake control).

NOTE: When your hands are detected, the message disappears and Autosteer resumes normal operation.

NOTE: Autosteer may also sound a chime at the same time that the message is initially displayed.

Autosteer requires that you pay attention to your surroundings and remain prepared to take control at any time. If Autosteer still does not detect your hands on the steering wheel, the request escalates by sounding chimes that increase in frequency.

If you repeatedly ignore Autosteer's prompts for having your hands on the steering wheel, Autosteer disables for the rest of the drive and displays the following message. If you don't resume manual steering, Autosteer sounds a continuous chime, turns on the warning flashers, and slows the vehicle to a complete stop.

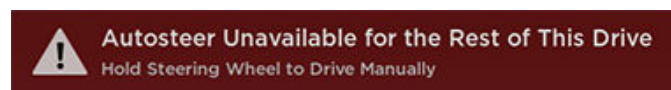

For the rest of the drive, you must steer manually. Autosteer is available again on your next drive (after you stop and shift Model S into Park).

Autosteer is Aborting

In situations where Autosteer is unable to assist in steering Model S, Autosteer aborts, sounds a warning chime, and displays the following message on the instrument panel:

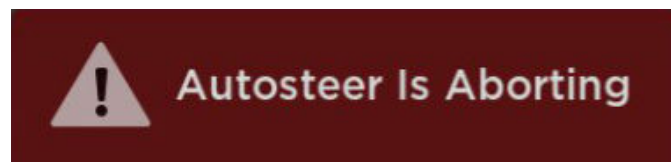

Canceling Autosteer

Autosteer cancels when:

- You apply rotational force to the steering wheel (even a slight amount).
- You press the brake pedal.
- You push the Autopilot stalk away from you.
- The maximum speed that Autosteer supports—150 km/h—is exceeded.
- You shift into a different gear.
- A door is opened.
- An Automatic Emergency Braking event occurs (see [Collision Avoidance Assist on page 112](#)).

When Autosteer cancels, it sounds chimes and the Autosteer icon either turns gray to indicate that Autosteer is no longer active, or disappears to indicate that it is not currently available.







NOTE: If Autosteer cancels because you applied rotational force to the steering wheel, Traffic-Aware Cruise Control remains active. Disengage Traffic-Aware Cruise Control as you normally would, by briefly pushing the Autopilot stalk away from you or pressing the brake pedal.

To disable Autosteer so it is no longer available, touch **Controls > Autopilot > Autosteer (Beta)**.

Auto Lane Change

NOTE: Depending on market region, vehicle configuration, options purchased, and software version, your vehicle may not be equipped with Auto Lane Change.

When Autosteer is active on a vehicle equipped with Auto Lane Change, you can use the turn signals to move Model S into an adjacent lane.

-  **WARNING:** It is the driver's responsibility to determine whether a lane change is safe and appropriate. Therefore, before initiating a lane change, always check blind spots, lane markings, and the surrounding roadway to confirm it is safe and appropriate to move into the target lane.
-  **WARNING:** Never depend on Auto Lane Change to determine an appropriate driving path. Drive attentively by watching the road and traffic ahead of you, checking the surrounding area, and monitoring the instrument panel for warnings. Always be prepared to take immediate action.
-  **WARNING:** Do not use Auto Lane Change on city streets or on roads where traffic conditions are constantly changing and where bicycles and pedestrians are present.
-  **WARNING:** The performance of Auto Lane Change depends on the ability of the camera(s) to recognize lane markings.
-  **WARNING:** Do not use Auto Lane Change on winding roads with sharp curves, on icy or slippery roads, or when weather conditions (such as heavy rain, snow, fog, etc.) may be obstructing the view from the camera(s) or sensors.
-  **WARNING:** Failure to follow all warnings and instructions can result in property damage, serious injury or death.

Operating Auto Lane Change

Auto Lane Change is available whenever Autosteer is active. To change lanes using Auto Lane Change:

1. Perform visual checks to make sure it is safe and appropriate to move into the target lane
2. Fully engage the appropriate turn signal and initiate the lane change by having your hands on the steering wheel.

3. Disengage the turn signal after you are in the target lane.

Auto Lane Change assists in moving Model S into the adjacent lane in the direction indicated by the turn signal, provided the following conditions are met:

- Auto Lane Change detected your hands on the steering wheel.
- The turn signal is engaged.
- The ultrasonic sensors and Autopilot cameras do not detect a vehicle or obstacle up to the center of the target lane.
- The lane markings indicate that a lane change is permitted.
- The view of the camera(s) is not obstructed.
- Your vehicle does not detect another vehicle in its blind spot.
- Midway through the lane change, Auto Lane Change can detect the outside lane marking of the target lane.
- Driving speed is at least 45 km/h.

As the lane change is in progress, Overtake Acceleration is activated, allowing Model S to accelerate closer to a vehicle in front (see [Overtake Acceleration on page 85](#)). Midway through the lane change, Auto Lane Change must detect the target lane's outside lane marking. If this lane marking cannot be detected, the lane change is aborted and Model S returns to its original driving lane.

NOTE: Auto Lane Change assists in moving Model S one lane at a time. Moving into an additional lane requires you to engage the turn signal a second time after the first lane change is complete.

When using Auto Lane Change, it is important to monitor its performance by watching the driving path in front of you and the surrounding area. Stay prepared to take over steering at any time. As you are crossing over into the adjacent lane, the instrument panel displays the lane marking as a dashed blue line. Once in your new lane, lane markings are displayed as solid blue lines again.

In situations where Auto Lane Change is unable to operate at optimal performance, or cannot operate due to inadequate data, the instrument panel displays a series of warnings. Therefore, when using Auto Lane Change, always pay attention to the instrument panel and be prepared to manually steer Model S.

Stop Light and Stop Sign Warning

NOTE: Depending on market region, vehicle configuration, options purchased, and software version, your vehicle may not be equipped with Stop Light and Stop Sign Warning.

While Autosteer is in use, Model S displays a warning on the instrument panel and sounds a chime if it detects that you are likely to run through a red stop light or stop sign. If this happens, **TAKE IMMEDIATE CORRECTIVE ACTION!**

The visual and audible warnings cancel after a few seconds, or when you press the brake pedal, whichever comes first.

Stop Light and Stop Sign Warning provides warnings only. It makes no attempt to slow down or stop Model S at red traffic lights, stop signs, road markings, etc. If your vehicle is equipped with Traffic Light and Stop Sign Control, you can enable this feature to automatically stop Model S at traffic lights and stop signs (see [Traffic Light and Stop Sign Control on page 94](#)).

NOTE: Touch **Controls > Autopilot > Full Self-Driving Visualization Preview** (if equipped) to display more details about the roadway and its surroundings, such as road markings, stop lights, objects (such as trash cans and poles), etc.

 **CAUTION:** Stop Light and Stop Sign Warning requires the vehicle's map to know that a particular stop light or stop sign exists in a certain location. It may be unaware of new stop lights or stop signs that are not captured in the map data. Therefore, Stop Light and Stop Sign Warning may not detect all stop lights and stop signs due to potential map inaccuracies.

 **WARNING:** Stop Light and Stop Sign Warning do not apply the brakes or decelerate Model S and may not detect all stop lights and stop signs. Stop Light and Stop Sign Warning are designed for guidance purposes only and are not a substitute for attentive driving and sound judgment. Keep your eyes on the road when driving and never depend on Stop Light and Stop Sign Warning to warn you of a stop light or stop sign.

 **WARNING:** Stop Light and Stop Sign Warning are designed to only warn you when approaching a visible red stop sign, solid red or later portion of a yellow traffic light; it may not issue warnings at intersections with flashing lights and does not warn you of yield signs or temporary stop and yield signs (such as in construction areas). Additionally, Stop Light and Stop Sign Warning will not warn you of an approaching stop light or stop sign if you are pressing the accelerator pedal or brake pedal (which disables Autosteer).

- Autosteer is unable to accurately determine lane markings. For example, lane markings are excessively worn, have visible previous markings, have been adjusted due to road construction, are changing quickly (lanes branching off, crossing over, or merging), objects or landscape features are casting strong shadows on the lane markings, or the road surface contains pavement seams or other high-contrast lines.
- Visibility is poor (heavy rain, snow, fog, etc.) or weather conditions are interfering with sensor operation.
- A camera(s) or sensor(s) is obstructed, covered, or damaged.
- Driving on hills.
- Approaching a toll booth.
- Driving on a road that has sharp curves or is excessively rough.
- Bright light (such as direct sunlight) is interfering with the view of the camera(s).
- The sensors are affected by other electrical equipment or devices that generate ultrasonic waves.
- A vehicle is detected in your blind spot when you engage the turn signal.
- Model S is being driven very close to a vehicle in front of it, which is blocking the view of the camera(s).

 **WARNING:** Many unforeseen circumstances can impair the operation of Autosteer. Always keep this in mind and remember that as a result, Autosteer may not assist in steering Model S appropriately. Always drive attentively and be prepared to take immediate action.

Limitations

Autosteer and its associated functions are particularly unlikely to operate as intended when:



NOTE: Navigate on Autopilot is a BETA feature and is not available in all market regions.

When using Autosteer on a controlled-access road (such as a highway or freeway), Navigate on Autopilot guides Model S to off-ramps and interchanges based on your navigation route. Along the highway portion of a navigation route, Navigate on Autopilot also changes lanes to prepare for exits and to minimize the driving time to your destination.

WARNING: Navigate on Autopilot does not make driving autonomous. You must pay attention to the road, keep your hands on the steering wheel at all times, and remain aware of your navigation route.

WARNING: As is the case with normal driving, be extra careful around blind corners, highway interchanges, and exits because obstacles can appear quickly and at any time.

WARNING: Navigate on Autopilot may not recognize or detect oncoming vehicles, stationary objects, and special-use lanes such as those used exclusively for bikes, carpools, emergency vehicles, etc. Remain alert at all times and be prepared to take immediate action. Failure to do so can cause damage, injury or death.

Enabling and Customizing Navigate on Autopilot

To enable Navigate on Autopilot, touch **Controls > Autopilot > Navigate on Autopilot (Beta)**. Then, to customize how you want Navigate on Autopilot to operate, touch **CUSTOMIZE NAVIGATE ON AUTOPILOT**:

- **Enable At Start Of Every Trip:** Choose whether or not you want to automatically enable Navigate on Autopilot for every navigation route. When enabled, the Navigate on Autopilot button on the turn-by-turn direction list is already enabled at the start of every trip.
- **Speed Based Lane Changes:** Navigate on Autopilot is designed to perform both route-based and speed-based lane changes. Route-based lane changes are designed to keep you on your navigation route (for example, moving you into an adjacent lane to prepare for an upcoming off-ramp) whereas speed-based lane changes are designed to maintain a driving speed (not to exceed your cruising speed) that allows you to minimize the time it takes to reach your destination (for example, moving into an adjacent lane to pass a vehicle in front of you). Speed-based lanes changes are optional. You can use this setting to disable speed-based lane changes or to specify how aggressively you want Navigate on Autopilot to change lanes to achieve the set cruising speed. The **MILD** setting is more conservative about lane changes and may result in a slightly longer driving time whereas **MAD MAX** is designed to allow

you to reach your destination in the shortest driving time possible, but will only change lanes when safe to do so.

- **Exit Passing Lane:** Choose whether you want Navigate on Autopilot to maneuver out of a passing lane when navigating to a destination.

NOTE: In addition to route-based and speed-based lane changes, Navigate on Autopilot requests a lane change out of a passing lane as a reminder to stay in a slower lane when you are not passing other vehicles. Choose **NO** to disable this and keep Model S in a passing lane except when needed to stay on the navigation route.

- **Require Lane Change Confirmation:** By default, Navigate on Autopilot requires your confirmation before proceeding with a lane change (by engaging the appropriate turn signal). However, if you want Navigate on Autopilot to change lanes without requiring this confirmation, turn this setting off. When you turn the setting off, you can specify if or how you want to be notified of lane changes (**Off**, **Chime**, **Vibrate**, or **Both**).

WARNING: If you turn off **Require Lane Change Confirmation**, Navigate on Autopilot notifies you of upcoming lane changes and off-ramps, but it remains your responsibility to monitor the environment and maintain control of Model S at all times. Lane changes can occur quickly and suddenly. Always keep your hands on the wheel and your eyes on the driving path in front of you.

NOTE: The touchscreen displays route-based lane changes at the top of the map's turn-by-turn direction list to notify you that an upcoming lane change is needed to stay on the navigation route.

Operating Navigate on Autopilot

Once enabled, the Navigate on Autopilot button appears on the map's turn-by-turn direction list whenever a navigation route is active and the route includes at least one controlled-access road. Touch this button to allow Navigate on Autopilot to assist you on your journey. When enabled, the Navigate on Autopilot button is blue and the turn-by-turn direction displays the Autosteer icon next to maneuvers (such as freeway exits) that Navigate on Autopilot will handle.

Navigate on Autopilot activates and deactivates as appropriate, based on the type of road you are driving on. For example, if Autosteer is active and the Navigate on Autopilot setting is turned on, Navigate on Autopilot automatically becomes active when you reach a supported controlled-access portion of your navigation route.

Whenever Navigate on Autopilot is active, the instrument panel displays the driving lane as a single blue line in front of Model S:



Navigate on Autopilot

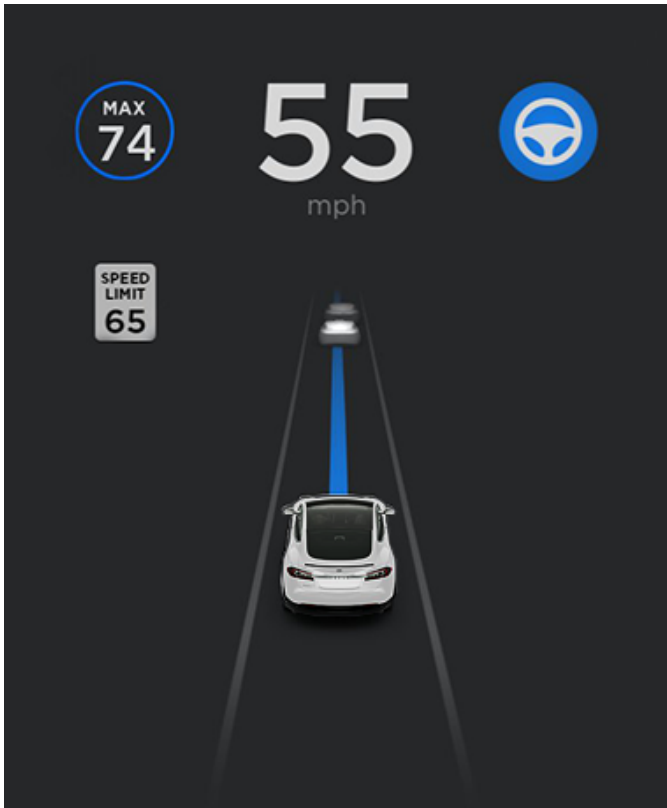

When Navigate on Autopilot is active and you approach an off-ramp or freeway interchange along your navigation route, the appropriate turn signal engages and Autosteer maneuvers Model S onto the off-ramp or interchange.

WARNING: Never depend on Navigate on Autopilot to determine an appropriate lane at an off-ramp. Stay alert and perform visual checks to ensure that the driving lane is safe and appropriate.

When you leave a controlled-access road (for example, you exit a freeway or you enter a section of the navigation route that is no longer supported), Navigate on Autopilot reverts back to Autosteer— a unique triple-tone chime sounds and the instrument panel displays the driving lane lines in blue (instead of the single blue in front of Model S). When you exit onto an off-ramp, the instrument panel briefly displays a countdown message warning you of the distance remaining before Navigate on Autopilot reverts back to Autosteer.

NOTE: The way Navigate on Autopilot determines navigation routes and maneuvers at freeway interchanges can be impacted by whether or not the navigation system is set up to use High Occupancy Vehicle (HOV) lanes. Therefore, ensure the **Use HOV Lanes** setting is appropriate for your circumstances (see [Maps and Navigation on page 128](#)). If the setting is off, Navigate on Autopilot never uses an HOV lane, regardless of time of day. If the setting is on, Navigate on Autopilot will always include the use of the HOV lane, whenever it exists.

WARNING: Even when Navigate on Autopilot deactivates at off-ramps, Autosteer remains active. Always be prepared to take appropriate actions such as stopping at red lights and stop signs, and yielding to other road users.

WARNING: Navigate on Autopilot may not always attempt to exit at an off-ramp, even when the exit is determined by the navigation route. Always remain alert and be prepared to manually steer onto the off-ramp, or make a required lane change.

You can cancel Navigate on Autopilot at any time by touching the **Navigate on Autopilot** button on the map's turn-by-turn direction list (your vehicle reverts back to Autosteer), or by canceling Autosteer entirely (see [Canceling Autosteer on page 88](#)).

Lane Changes

Navigate on Autopilot changes lanes to either prepare Model S for an upcoming off-ramp, to increase your driving speed (not to exceed your set cruising speed), or to move Model S out of a passing lane when you are not actively passing other vehicles. A message displays at the top of the map's turn-by-turn direction list to notify you when an upcoming lane change is required to stay on your navigation route. The line on the instrument panel shows the upcoming driving path:

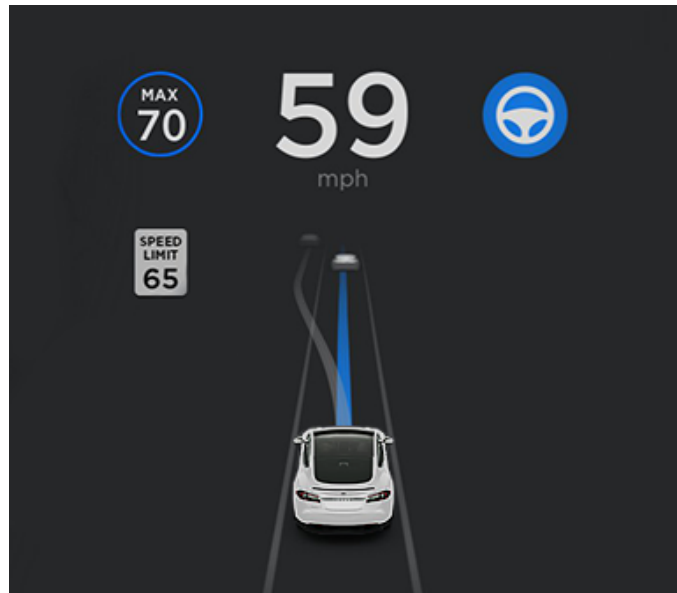

If **Require Lane Change Confirmation** is turned off, Navigate on Autopilot engages the appropriate turn signal, checks for vehicles and objects, and when appropriate, maneuvers Model S into the adjacent lane.



If **Require Lane Change Confirmation** is turned on, you must engage the appropriate turn signal to confirm that you want Navigate on Autopilot to make the lane change. If you do not confirm the lane change within three seconds, a chime sounds to remind you that Navigate on Autopilot requires your confirmation to change lanes.

NOTE: If you ignore a route-based lane change suggestion (for example, you are driving in the left lane while approaching an off-ramp on the right side of the highway), Navigate on Autopilot will be unable to maneuver onto the off-ramp and as a result, the navigation system will re-route you to your destination.

 **WARNING:** Navigate on Autopilot may not always attempt to exit at an off-ramp or change lanes, even when an exit or lane change is determined by the navigation route. Always remain alert and be prepared to manually steer onto an off-ramp, or make a lane change to prepare for, or to exit at, an off-ramp or interchange.

Be Ready to Assist

When attempting to change lanes or maneuver Model S, or when approaching construction zones, Navigate on Autopilot may be unable to determine the appropriate driving lane (for example, complex clover leaves and multi-lane off-ramps) and the instrument panel displays an alert indicating that Navigate on Autopilot is trying to maneuver and may require assistance. When you see the message, be prepared to take immediate action to ensure that it is safe and appropriate to complete the lane change or maneuver.



Traffic Light and Stop Sign Control

NOTE: Depending on market region, vehicle configuration, options purchased, and software version, your vehicle may not be equipped with Traffic Light and Stop Sign Control.

Traffic Light and Stop Sign Control is designed to recognize and respond to traffic lights and stop signs, slowing Model S to a stop when using Traffic-Aware cruise control or Autosteer. This feature uses the vehicle's forward-facing cameras, in addition to GPS data, and slows the car for all detected traffic lights, including green, blinking yellow, and off lights in addition to stop signs and some road markings. As Model S approaches an intersection, the instrument panel displays a notification indicating the intention to slow down. You must confirm that you want to continue or Model S stops at the red line displayed on the instrument panel's driving visualization.

NOTE: Traffic Light and Stop Sign Control is a BETA feature and works best on roads that are frequently driven by Tesla vehicles. Traffic Light and Stop Sign Control attempts to stop at all traffic lights, including green lights.

⚠ WARNING: NEVER make assumptions and predict when and where Traffic Light and Stop Sign Control will stop or continue through an intersection or road marking. From a driver's perspective, the behavior of Traffic Light and Stop Sign Control may appear inconsistent. Always pay attention to the roadway and be prepared to take immediate action. It is the driver's responsibility to determine whether to stop or continue through an intersection. Never depend on Traffic Light and Stop Sign Control to determine when it is safe and/or appropriate to stop or continue through an intersection.

Before Using

Before using Traffic Light and Stop Sign Control, you must:

- Ensure that forward-facing cameras are unobstructed (see [Cleaning Cameras and Sensors on page 81](#)) and calibrated (see [Drive to Calibrate Cameras on page 80](#)). Traffic Light and Stop Sign Control depends on the ability of the cameras to detect traffic lights, stop signs, and road markings.
- Ensure that the latest version of maps has been downloaded to Model S. Although Traffic Light and Stop Sign Control primarily uses visual data received from the vehicle's cameras, greater accuracy is achieved when using the most recent map data. To check which version of maps is currently downloaded, touch **Controls** > **Service** > **Additional vehicle information**. You must connect to a Wi-Fi network to receive updated maps (see [Map Updates on page 132](#)).
- Enable the feature. With the vehicle in Park, touch **Controls** > **Autopilot** > **Traffic Light and Stop Sign Control**. Once enabled, Traffic Light and Stop Sign Control operates whenever Traffic-Aware Cruise Control or Autosteer is active.

How it Works

When Traffic Light and Stop Sign Control is enabled and you are using Autosteer or Traffic-Aware Cruise Control, the instrument panel displays a popup message to inform you that an upcoming traffic light, stop sign, or road marking has been detected. As it approaches the stop location, **even at an intersection where the traffic light is green**, Model S slows down and displays a red line to indicate where the vehicle will come to a complete stop. To continue through the intersection—even if the traffic light is green—you must pull the Autopilot stalk toward you or briefly press the accelerator pedal to give the vehicle permission to proceed. When you've confirmed that you want to proceed, the red stop line turns grey and Model S continues through the intersection and resumes your set cruising speed.

NOTE: If Model S is approaching a green light and detects that a vehicle in front of you is continuing through the intersection, Model S will continue through the intersection without requiring your confirmation, provided you are not in a turning lane and your hands are detected on the steering wheel.







NOTE: If, after you pull the Autopilot stalk toward you or press the accelerator pedal to confirm that you want to continue through the intersection, the traffic signal changes before you enter the intersection (for example, the light changes from green to yellow or from yellow to red), Model S may determine that it is not appropriate to proceed. Therefore, Model S stops and you must manually press the accelerator to proceed. At all times, it is your responsibility to ensure the vehicle stops or accelerates appropriately and safely.

⚠ WARNING: Traffic Light and Stop Sign Control WILL NOT turn Model S through an intersection. When in a turning lane, Model S stops at the red stop line. To proceed, pull the Autopilot stalk toward you or briefly press the accelerator pedal—Model S will continue *straight* through the intersection (even when in a turning lane), so you MUST manually steer Model S through the intersection (which cancels Autosteer).

Traffic Light and Stop Sign Control is designed to operate as described only when the following conditions are met:



- Autosteer or Traffic-Aware Cruise Control is engaged.
- The cameras can detect an upcoming traffic light, stop sign or road marking (for example, cameras are unobstructed and have a clear line-of-sight to the traffic light, stop sign, or road marking).
- The instrument panel on Model S is displaying an upcoming traffic light in "bold" format. Model S does not acknowledge traffic lights that the instrument panel shows as faded. If a traffic light is not directly ahead of the camera (for example, it is located at an angle of the camera's view, or located in an adjacent lane) the instrument panel displays it as faded and Model S does not slow down and stop for it.







-  **WARNING:** If the instrument panel is not displaying a red stop line at an upcoming intersection, Model S does not slow down or stop. It is the driver's responsibility to pay attention to upcoming intersections and monitor traffic conditions to determine when and if the vehicle should stop and then to take appropriate action as needed.
-  **WARNING:** Never depend on Traffic Light and Stop Sign Control to determine whether to stop at, or proceed through, an intersection. Drive attentively by watching the road and paying attention to the roadway, upcoming intersections, traffic conditions, crosswalks, and other road users. It is always the driver's responsibility to determine whether to stop or proceed. Be prepared to take immediate action. Failure to do so can result in injury or death.
-  **WARNING:** In some situations, Traffic Light and Stop Sign Control may inaccurately detect a traffic light or stop sign, causing Model S to slow down unexpectedly. Be prepared to take immediate action at all times.
-  **WARNING:** You must pull the Autopilot stalk toward you or briefly press the accelerator pedal to confirm that you want to proceed through an intersection, regardless of the status of the traffic light. If you do not confirm, Model S stops at the red stop line displayed on the instrument panel, even if a stop may not be appropriate. Stopping at a green light may confuse other drivers and may result in a collision, injury or death. Therefore, always pay attention to upcoming intersections and be prepared to manually brake or accelerate in response to surroundings.
-  **WARNING:** Never assume that your ability to see a traffic light, stop sign, or road marking (especially at a complex intersection, or an intersection in which a traffic light or sign is partially obstructed, etc.) means that Model S can also identify it and respond appropriately.
-  **WARNING:** Even the most recent map data does not include all traffic lights and stop signs. Therefore, Traffic Light and Stop Sign Control relies heavily on the ability of the cameras to detect traffic lights, stop signs, road markings, etc. As a result, Model S may ignore an intersection that is blocked from the camera's view (for example, obstructed by a tree or a large vehicle or object, or located near a steep hill or sharp curve).
-  **WARNING:** Traffic Light and Stop Sign Control is not a substitute for attentive driving and sound judgment.



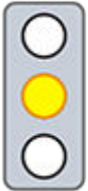

Traffic Light and Stop Sign Control

Traffic Lights

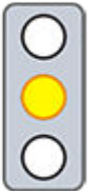
When driving with Autosteer or Traffic-Aware Cruise Control engaged, and Traffic Light and Stop Sign Control enabled, Model S is designed to respond as follows when approaching intersections controlled by a traffic light:

Type of Traffic Light	Vehicle Intended Response
 	<p>At a solid green traffic light, or at a traffic light that is currently off (not illuminated), Model S slows down.</p> <p>If you are following a car in front of you that continues through the intersection, a green stop line displays on the instrument panel and provided your hands are detected on the steering wheel, Model S also continues. If a car is not in front of you, a red stop line displays on the instrument panel and you must confirm that you want to continue through the intersection by pulling the Autopilot stalk toward you or briefly pressing the accelerator pedal. If you don't confirm, Model S stops at the red stop line.</p> <p>NOTE: Model S resumes the set cruising speed when it continues through the intersection, taking into consideration the speed of a vehicle is in front of you.</p>
 	<p>Model S slows down and comes to a complete stop at the red stop line shown on the instrument panel. When you want to continue through the intersection (for example, after the light turns green again, or once Model S has come to a complete stop), you must pull the Autopilot stalk toward you or briefly press the accelerator pedal.</p>
  	<p>Model S slows down and comes to a complete stop at the red stop line shown on the instrument panel. When you want to proceed through the intersection (for example, after the light turns green again), you must pull the Autopilot stalk toward you or briefly press the accelerator pedal.</p> <p>NOTE: If the traffic light changes <i>after</i> you've confirmed that you want to proceed (for example, a green traffic light turns yellow), Model S may stop instead of continuing, especially if Model S determines that it can safely stop before entering the intersection.</p> <p>NOTE: Model S is not designed to proceed through an intersection when the traffic light is red or if the light turns yellow when there is adequate distance to safely stop before the intersection.</p> <p>NOTE: You can take over driving at any time by manually braking to cancel Autosteer or Traffic-aware Cruise Control.</p>

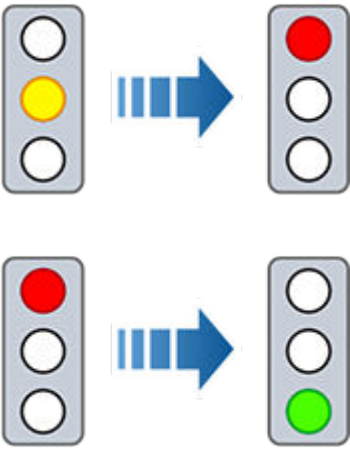

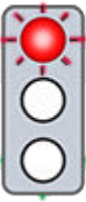



Type of Traffic Light	Vehicle Intended Response
	
	<p>Model S slows down. To proceed, you must pull the Autopilot stalk toward you or briefly press the accelerator pedal. If you don't, Model S stops at the red stop line shown on the instrument panel.</p> <p>NOTE: To prevent Model S from stopping and to minimize how much it slows down as it approaches, you can confirm that you want to proceed by pulling the Autopilot stalk toward you or pressing the accelerator pedal at any time after the instrument panel displays the red stop line. Model S resumes your set cruising speed immediately after you confirm (taking into consideration whether a vehicle is in front of you).</p> <p>⚠ WARNING: Approach attentively and be prepared to press the brake pedal to slow down or stop.</p>
	<p>Model S slows down and comes to a complete stop at the red stop line shown on the instrument panel. When you want to proceed through the intersection (for example, traffic laws and conditions indicate it is safe and legal to proceed), you must pull the Autopilot stalk toward you or briefly press the accelerator pedal.</p>



Traffic Light and Stop Sign Control

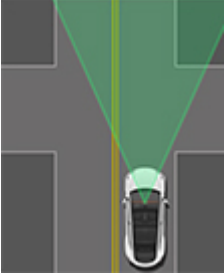

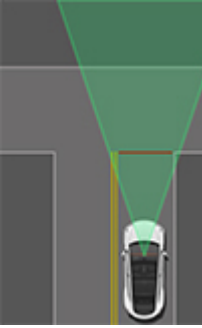
Stop Signs and Road Markings

When driving with Autosteer or Traffic-aware Cruise Control engaged, and Traffic Light and Stop Sign Control enabled, Model S is designed to respond as follows when approaching intersections controlled by stop signs, stop lines, or road markings:

Type of Intersection	Vehicle Intended Response
 <p data-bbox="164 741 386 772">No Traffic Control</p>  <p data-bbox="164 1024 386 1056">Arm of T-junction</p>	<p data-bbox="459 436 1450 499">Model S assumes the right of way and continues straight without slowing down or stopping.</p>
 <p data-bbox="175 1455 375 1486">End of T-junction</p>	<p data-bbox="459 1098 1450 1182">If the vehicle can detect a T-junction based on the map data, Model S slows down and comes to a complete stop at the red stop line shown on the instrument panel. When you want to proceed, you must take over steering and acceleration.</p> <p data-bbox="459 1203 1450 1287">⚠ WARNING: Model S may not stop at a T-junction that does not have a stop sign or stop line, or if the map data does not detect a T-junction. Drive attentively and be prepared to stop the vehicle when needed.</p>
 <p data-bbox="215 1885 334 1917">Stop Sign</p>	<p data-bbox="459 1528 1450 1612">Model S slows down and comes to a complete stop at the red stop line shown on the instrument panel. When you want to proceed through the intersection, you must pull the Autopilot stalk toward you or briefly press the accelerator pedal.</p> <p data-bbox="459 1633 1450 1738">NOTE: If you confirm that you want to proceed through an intersection controlled by a stop sign by pulling the Autopilot stalk toward you or pressing the accelerator pedal before Model S has stopped, your confirmation is ignored. Model S is not designed to proceed through a stop sign without stopping.</p> <p data-bbox="459 1759 1450 1843">NOTE: Even when using Autosteer, and even if you have engaged a turn signal, you must turn the steering wheel yourself (which cancels Autosteer) to complete a turn at an intersection.</p>

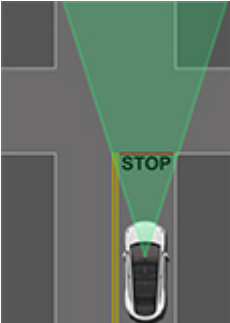

Type of Intersection	Vehicle Intended Response
 <p data-bbox="152 571 490 600">Stop Sign and Road Marking</p>	
 <p data-bbox="240 978 402 1008">Road Marking</p>	

-  **WARNING:** Model S also slows down and stops at a roundabout. You must take over steering (which cancels Autosteer) and pull the Autopilot stalk toward you or briefly press the accelerator pedal to confirm that you want to continue through the roundabout.
-  **WARNING:** At crosswalks, Model S may slow down and may stop, depending on whether the crosswalk is controlled by a traffic light and whether the cameras detect pedestrians, bicyclists, etc. in the crosswalk. Pay particular attention at crosswalks and be prepared to take over at any time. Failure to do so can result in injury or death.

Limitations

Depending on many different circumstances and environmental conditions, Traffic Light and Stop Sign Control *may* or *may not* stop at:

- Railroad crossings.
- Keep-out zones.
- Toll booths.
- Crosswalk systems.
- Yield signs or temporary traffic lights and stop signs (such as at construction areas).
- Miscellaneous traffic U-turn lights, bicycle and pedestrian crossing lights, lane availability lights, etc.

In addition, Traffic Light and Stop Sign Control is particularly unlikely to operate as intended, can disengage, or may not operate, when one or more of the following conditions are present:

- Driving through consecutive light-controlled intersections that are very close to each other.
- Visibility is poor (heavy rain, snow, fog, etc.) or weather conditions are interfering with camera or sensor operation.
- Bright light (such as direct sunlight) is interfering with the view of the camera(s).



Traffic Light and Stop Sign Control

- A camera is obstructed, covered, damaged, or not properly calibrated.
- Driving on a hill or on a road that has sharp curves on which the cameras are unable to see upcoming traffic lights or stop signs.
- A traffic light, stop sign, or road marking is obstructed (for example, a tree, a large vehicle, etc.).
- Model S is being driven very close to a vehicle in front of it, which is blocking the view of a camera.

 **WARNING:** The limitations listed above are not an exhaustive list of reasons why Model S may not operate as expected. Many unforeseen circumstances can adversely impact the accurate operation of Traffic Light and Stop Sign Control. Using this feature does not reduce or eliminate the need to drive attentively and responsibly. You must be prepared to take appropriate and immediate action at all times.

NOTE: Depending on market region, vehicle configuration, options purchased, and software version, your vehicle may not be equipped with Autopark.

Autopark uses data from the ultrasonic sensors and GPS to simplify parking on public roads by maneuvering Model S into parallel and perpendicular parking spaces. See [To Use Autopark on page 101](#).

 **CAUTION:** Ensure all cameras and sensors are clean. Unclean cameras and sensors, as well as environmental conditions such as rain and faded lane markings, can affect Autopilot performance.

 **WARNING:** Autopark's performance depends on the ability of the ultrasonic sensors to determine the vehicle's proximity to curbs, objects, and other vehicles.

To Use Autopark

When driving, follow these steps to allow Autopark to maneuver Model S into a parking space:

1. When driving slowly on a public road, monitor the instrument panel to determine when Autopark has detected a parking space. When Autopark detects a potential parking space, the instrument panel displays a parking icon. Autopark detects parallel parking locations when driving below 24 km/h and perpendicular parking locations when driving below 16 km/h.



NOTE: The parking icon appears only if the vehicle's position and/or the circumstances of the surrounding area are such that Autopark can determine an appropriate driving path. If Autopark cannot determine an appropriate path (for example, when driving on a narrow street where moving into the parking space causes the front of the vehicle to extend into the adjacent lane), you can either reposition the vehicle, find a different parking space, or park manually.

2. Check to determine if the detected parking space is appropriate and safe. If so, pull forward and stop approximately a car length ahead of the parking space (as you normally would when parallel parking or when backing into a perpendicular parking space).
3. Release the steering wheel, shift Model S into Reverse, then touch **Start Autopark** on the touchscreen.
4. When parking is complete, Autopark displays the "Complete" message.

In situations where Autopark cannot operate due to inadequate sensor data, the instrument panel displays a message indicating that you must manually park Model S.

NOTE: If you press the brake when Autopark is actively parking Model S, the parking process pauses until you touch **Resume** on the touchscreen.

NOTE: Autopark detects potential perpendicular parking spaces that are at least 2.9 meters wide with a vehicle parked on each side. Autopark detects parallel parking spaces that are at least 6 meters, but less than 9 meters long. Autopark does not operate on angled parking spaces.

 **WARNING:** Never depend on Autopark to find a parking space that is legal, suitable, and safe. Autopark may not always detect objects in the parking space. Always perform visual checks to confirm that a parking space is appropriate and safe.

 **WARNING:** When Autopark is actively steering Model S, the steering wheel moves in accordance with Autopark's adjustments. Do not interfere with the movement of the steering wheel. Doing so cancels Autopark.

 **WARNING:** During the parking sequence, continually check your surroundings. Be prepared to apply the brakes to avoid vehicles, pedestrians, or objects.

 **WARNING:** When Autopark is active, monitor the touchscreen and instrument panel to ensure that you are aware of the instructions that Autopark is providing.

To Pause Parking

To pause Autopark, press the brake pedal once. Model S stops and remains stopped until you touch **Resume** on the touchscreen.

To Cancel Parking

Autopark cancels the parking sequence when you manually move the steering wheel, change gears, or touch **Cancel** on the touchscreen. Autopark also cancels parking when:

- The parking sequence exceeds seven moves.
- Model S detects that the driver is exiting the vehicle.
- A door is opened.
- You press the accelerator pedal.
- You press the brake pedal while Autopark is paused.
- An Automatic Emergency Braking event occurs (see [Collision Avoidance Assist on page 112](#)).

Limitations

Autopark is particularly unlikely to operate as intended in these situations:

- The road is sloped. Autopark is designed to operate on flat roads only.
- Visibility is poor (due to heavy rain, snow, fog, etc.).
- The curb is constructed of material other than stone, or the curb cannot be detected.
- The target parking space is directly adjacent to a wall or pillar (for example, the last parking space of a row in an underground parking structure).
- One or more of the ultrasonic sensors is damaged, dirty, or obstructed (such as by mud, ice, or snow).
- Weather conditions (heavy rain, snow, fog, or extremely hot or cold temperatures) are interfering with sensor operation.
- The sensors are affected by other electrical equipment or devices that generate ultrasonic waves.

 **WARNING:** Many unforeseen circumstances can impair Autopark's ability to park Model S. Keep this in mind and remember that as a result, Autopark may not steer Model S appropriately. Pay attention when parking Model S and stay prepared to immediately take control.

NOTE: Depending on market region, vehicle configuration, options purchased, and software version, your vehicle may not be equipped with Summon.

Summon allows you to automatically park and retrieve Model S while you are standing outside the vehicle. Summon uses data from the ultrasonic sensors to move Model S forward and reverse up to 12 meters in, or out of, a parking space.

To move Model S a longer distance while steering around objects, you can use Smart Summon (if equipped) and your mobile phone. Smart Summon allows your vehicle to find you (or you can send your vehicle to a chosen location). See [Smart Summon on page 106](#).

 **CAUTION:** Ensure all cameras and sensors are clean. Unclean cameras and sensors, as well as environmental conditions such as rain and faded lane markings, can affect Autopilot performance.

 **WARNING:** Summon is designed and intended for use only on parking lots and driveways on private property where the surrounding area is familiar and predictable.

 **WARNING:** Summon is a BETA feature. You must continually monitor the vehicle and its surroundings and stay prepared to take immediate action at any time. It is the driver's responsibility to use Summon safely, responsibly, and as intended.

 **WARNING:** Summon's performance depends on the ability of the ultrasonic sensors to determine the vehicle's proximity to objects, people, animals, and other vehicles.

Before Using Summon

Before operating Summon, use the touchscreen to enable it and customize how you want it to work. Touch **Controls > Autopilot > Summon**, then touch **Customize** and adjust the following settings to suit your preferences:

- **Bumper Clearance:** Set the distance that you want Summon to stop from a detected object (for example, you may want Summon to stop within just a few inches of a garage wall). Note that this distance applies only to objects that Summon detects directly in front of Model S when moving forward, or directly behind Model S when reversing.
- **Summon Distance:** Set a maximum distance that Model S can travel when entering or exiting a parking space.
- **Side Clearance:** Choose an option to specify how much side clearance you want to allow. **Tight** allows Model S to enter and exit very narrow parking spaces.

 **WARNING:** Parking in a narrow space limits the ability of the sensors to accurately detect the location of obstacles, increasing the risk of damage to Model S and/or surrounding objects.

- **Require Continuous Press:** By default, Summon requires that you press and hold a button on the mobile app or key to move Model S during the parking process. When **Require Continuous Press** is set to **NO**, you can press and release the button—you don't need to hold it down to keep the vehicle moving. Also, **Require Continuous Press** must be set to **NO** if you want to operate Summon using the key instead of the mobile app (see [Operating Summon with the Key on page 104](#)), or if you want to start a parking sequence from inside the vehicle (see [Starting Summon Before Exiting the Vehicle on page 104](#)).
- **Use Auto HomeLink** (if equipped): Set to **ON** if you want to activate HomeLink to open/close a programmed HomeLink device (such as a gate or a garage door) during the parking process when using Summon. If enabled, the device automatically opens and closes when Model S enters or exits during a Summon session. In a Smart Summon session (if equipped), the device automatically opens when, at the beginning of a session, Smart Summon detects that Model S is parked in a garage.

 **WARNING:** Always ensure that Model S is fully in or out of a garage before HomeLink lowers the garage door. Summon and Smart Summon (if equipped) cannot detect where an overhead door will lower.

NOTE: When enabled, the HomeLink device automatically opens and closes when using Summon, and automatically opens as needed when using Smart Summon (if equipped). To automate HomeLink in other situations (such as normal driving), you must adjust the HomeLink device's main settings by touching the HomeLink icon at the top of the touchscreen (see [HomeLink Universal Transceiver on page 145](#)).

NOTE: The above settings, with the exception of HomeLink, apply only to Summon—not Smart Summon, if equipped (see [Before Using Smart Summon on page 106](#)). You cannot customize Smart Summon's bumper clearance, distance, and side clearance. And when using Smart Summon, you must always hold down the button on the mobile app to keep Model S moving. Also, Smart Summon operates with the mobile app only—not the key.

NOTE: All settings are retained until you manually change them.

Using Summon to Park and Retrieve your Vehicle

Follow these steps to use Summon to park your Model S:

- Align Model S within 12 meters of the parking space so Model S can follow a straight path into or out of the space in either Drive or Reverse.
- From outside the vehicle, initiate the parking maneuver by touching **Summon** on the mobile app, then holding down the **FORWARD** or **REVERSE** button.

NOTE: If the **Require Continuous Press** setting is **NO**, you do not need to hold down the button, just press and release.

NOTE: You can also initiate the parking maneuver from inside the vehicle (see [Starting Summon Before Exiting the Vehicle on page 104](#)).

Summon shifts Model S into Drive or Reverse (based on the direction you specified) and drives into or out of the parking space. When parking is complete, or if an obstacle is detected, Summon shifts Model S into Park. Summon shifts Model S into Park when:

- Model S detects an obstacle in its driving path (within the **Bumper Clearance** setting that you specified).
- Summon has moved Model S the maximum distance of 12 meters.
- You release the **FORWARD** or **REVERSE** button (when **Require Continuous Press** is turned on).
- You press any button to manually stop Summon.

If you used Summon to park Model S, you can then use Summon to return Model S back to its original position (provided the vehicle has remained in Park), or to the maximum **Summon Distance** that you have specified (whichever comes first). Simply specify the opposite direction on the mobile app and Summon moves the vehicle along the original path, provided no obstructions have been introduced. If the ultrasonic sensors detect an obstacle, Summon attempts to avoid the obstacle while staying very close to its original path (Summon does not steer around obstacles).

NOTE: To move Summon multiple times in the same direction (not to exceed the maximum of 12 meters, cancel Summon and then restart the parking process using the same direction.

NOTE: Although Summon can move Model S a short distance laterally to avoid an obstacle, it does not attempt to steer around an obstacle to return the vehicle to its original driving path. Only Smart Summon (if equipped) can steer the vehicle around objects.

NOTE: If you release the direction button on the mobile app, Summon stops moving Model S.

NOTE: Summon requires that Model S can detect a valid key nearby.



WARNING: Model S cannot detect obstacles that are located lower than the bumper, are very narrow, or are hanging from a ceiling (for example, bicycles). In addition, many unforeseen circumstances can impair Summon's ability to move in or out of a parking space and, as a result, Summon may not move Model S appropriately. Therefore, you must continually monitor the vehicle's movement and its surroundings and remain prepared to stop Model S at any time.

Operating Summon with the Key

NOTE: Summon may not operate if the key's battery is low.

Follow these steps to park Model S from outside the vehicle using the key:

1. On the touchscreen, ensure that **Require Continuous Press** is disabled (touch **Controls** > **Autopilot** > **Summon** > **Require Continuous Press** > **NO**).
2. With Model S in Park, stand within 3 meters and press and hold the top center button on the key (Lock/Unlock All button) until the hazard lights blink continuously.
NOTE: The hazard lights flash once as Model S locks, then within five seconds, Model S powers on and the hazard lights flash continuously. Do not proceed to the next step until the hazard lights are flashing. If, after five seconds, the hazard lights are not flashing, release the button on the key, move closer to Model S, and try again. If Summon receives no further input within ten seconds, Summon cancels.
3. Press the Front Trunk button on the key to move Model S forward into the parking space, or press the Rear Trunk button to reverse Model S into the parking space.

Starting Summon Before Exiting the Vehicle

To start a Summon parking sequence before exiting Model S:

1. On the touchscreen, ensure that **Require Continuous Press** is disabled (touch **Controls** > **Autopilot** > **Summon** > **Require Continuous Press** > **NO**).
2. Close all doors and trunks.
3. With Model S powered on and the Park gear engaged, double press the Park button on the drive stalk. The touchscreen displays a popup window.
4. On the touchscreen, choose the direction of travel.
5. Exit Model S and close the driver's door.

Summon now moves Model S according to the direction you specified on the touchscreen.

NOTE: To cancel the parking maneuver before exiting, touch **Cancel** on the popup window.

NOTE: If you do not choose a direction of travel on the touchscreen, Summon does not start a parking maneuver when you exit.

Stopping or Canceling Summon

You can stop Model S at any time while Summon is active by using the mobile app or by pressing any button on the key. Summon also cancels when:

- A door handle is engaged or a door is opened.
- You interact with the steering wheel, brake pedal, accelerator pedal, or drive stalk.
- Model S detects an obstacle.
- Summon has moved Model S the maximum distance of approximately 12 meters.
- Your phone enters sleep mode or loses connectivity to Model S.

Limitations

Summon is unlikely to operate as intended in the following types of situations:

- The driving path is sloped. Summon is designed to operate on flat roads only (up to 10% grade).
- A raised concrete edge is detected. Summon will not move the vehicle over an edge that is higher than approximately 2.5 cm.
- One or more of the ultrasonic sensors is damaged, dirty, or obstructed (such as by mud, ice, or snow, or by a vehicle bra, excessive paint, or adhesive products such as wraps, stickers, rubber coating, etc.).
- Weather conditions (heavy rain, snow, fog, or extremely hot or cold temperatures) are interfering with sensor operation.
- The sensors are affected by other electrical equipment or devices that generate ultrasonic waves.

NOTE: Summon is disabled if Model S is in Valet mode (see [Valet Mode on page 38](#)).

 **WARNING:** The list above does not represent an exhaustive list of situations that may interfere with proper operation of Summon. It is the driver's responsibility to remain in control of Model S at all times. Pay close attention whenever Summon is actively moving Model S and stay prepared to take immediate action. Failure to do so can result in serious property damage, injury or death.





Smart Summon

NOTE: Depending on market region, vehicle configuration, options purchased, and software version, your vehicle may not be equipped with Smart Summon.

Smart Summon is designed to allow you to move Model S to your location (using your phone's GPS as a target destination) or to a location of your choice, maneuvering around and stopping for objects as necessary. Smart Summon works with the Tesla mobile app when your phone is located within approximately 65 meters of Model S. Using ultrasonic sensors, cameras, and GPS data, Smart Summon maneuvers Model S out of parking spaces and around corners. This is useful for moving Model S out of a tight parking spot, through puddles, or helping you retrieve your car while carrying packages. You must maintain a clear line of sight between you and Model S and closely monitor the vehicle and its surroundings at all times.

 **CAUTION:** Ensure all cameras and sensors are clean. Unclean cameras and sensors, as well as environmental conditions such as rain and faded lane markings, can affect Autopilot performance.

 **WARNING:** Smart Summon is designed and intended for use only on parking lots and driveways located on private property where the surrounding area is familiar and predictable. Do not use Smart Summon on public roads.

 **WARNING:** Smart Summon must only be used on paved surfaces.

 **WARNING:** Smart Summon is a BETA feature. You must continually monitor the vehicle and its surroundings and stay prepared to take immediate action at any time. It is the driver's responsibility to use Smart Summon safely, responsibly, and as intended.

 **WARNING:** Smart Summon may not stop for all objects (especially very low objects such as some curbs, or very high objects such as a shelf) and may not react to all traffic. Smart Summon does not recognize the direction of traffic, does not navigate around empty parking spaces, and may not anticipate crossing traffic.

 **WARNING:** Smart Summon's performance depends on the ultrasonic sensors, the visibility of the cameras, and the availability of an adequate cellular signal and GPS data.

 **WARNING:** When using Smart Summon, you must maintain a clear line of sight between you and Model S and stay prepared to stop the vehicle at any time by releasing the button on the mobile app.

Before Using Smart Summon

- Download the latest version of the Tesla mobile app to your phone, and ensure your phone has cellular service and GPS enabled.
- Your phone must be connected to Model S and located within approximately 65 meters.

- The vehicle's Autopilot cameras must be fully calibrated (see [Drive to Calibrate Cameras on page 80](#)).
- You must have a clear line of sight to Model S.
- Model S must be in Park, not charging, and all doors and trunks must be closed.

Using Smart Summon

1. Open the Tesla mobile app, and press **SUMMON**.
2. Press the **Smart Summon** icon located in the center of the image of your Model S. It may take several seconds for Smart Summon to start up.

NOTE: You can use Standby Mode to eliminate the delay that occurs when Smart Summon is starting up (see [Standby Mode on page 107](#)).

The mobile app displays a map with a blue circle, which represents the maximum proximity of 65 meters that you must maintain between your phone and Model S. The blue dot on the map represents your location, and the red arrow represents the location of Model S.

3. Position yourself anywhere within the blue circle where you have a clear line of sight to Model S.
4. You can now operate Smart Summon using either of these modes:
 - **COME TO ME** mode: Press and hold the **COME TO ME** button. Model S moves to your GPS location. As you move, Model S follows you. When Model S reaches you, it stops and shifts into park.
 - **GO TO TARGET** mode: Touch the crosshair icon then drag the map to position the pin on a chosen destination. Press and hold the **GO TO TARGET** button. Model S moves to the destination. When reaching the location, Model S stops and shifts into Park and the mobile app displays a message indicating that Summon has completed.

NOTE: To subsequently change the location, lift your finger, reposition the map, then press and hold **GO TO TARGET** again.

To stop Model S at any time, simply release the **COME TO ME** or **GO TO TARGET** button.



The map's crosshair icon toggles between **GO TO TARGET** and **COME TO ME** modes. When **COME TO ME** mode is selected, the icon is blue.

NOTE: The map also has an icon that allows you to display/hide satellite imagery.



Immediately after initiating Smart Summon in either mode, hazard lights briefly flash, mirrors fold, and Model S shifts into the appropriate driving gear (Drive or Reverse). Model S then slowly moves to within 1 meter of you (COME TO ME) or your chosen destination (GO TO TARGET), navigating obstacles as needed. As Model S moves, the corresponding red arrow on the map also moves to show the vehicle's location. As you move, the corresponding blue dot also moves to show your location.



In either mode, Model S stops moving and shifts into park when:

- You release the button on the mobile app.
- The maximum proximity of 65 meters between your phone and Model S is exceeded (if moving Model S to a destination away from you, you may need to follow the car to maintain this distance).
- The driving path is blocked.
- Model S has moved the maximum distance of 145 meters since the start of the Smart Summon session, or has moved 150 meters away from the location from which the vehicle was last driven manually.

NOTE: If Smart Summon moves Model S forward three meters and then backwards two meters, this is considered five meters of travel.

NOTE: There is no need to look at the mobile app—just hold down the button while keeping your eye on Model S and its driving path at all times, remaining ready to release the button to stop the vehicle if needed.

If equipped and Auto HomeLink is enabled for Summon (touch **Controls** > **Autopilot** > **Summon** > **Use Auto HomeLink**, Smart Summon automatically opens a HomeLink device if you start the Smart Summon maneuver when Model S is located inside a garage. The mobile app informs you that the door has opened.

-  **WARNING:** When you release the button to stop Model S, a slight delay occurs before the vehicle stops. Therefore, it is critical that you pay close attention to the vehicle's driving path at all times and proactively anticipate obstacles that the vehicle may be unable to detect.
-  **WARNING:** Use extreme caution when using Smart Summon in environments where movement of obstacles can be unpredictable. For example, where people, children or animals are present.
-  **WARNING:** Smart Summon may not stop for all objects (especially very low objects such as some curbs, or very high objects such as a shelf) and may not react to all oncoming or side traffic. Pay attention and be ready to stop Model S at all times by releasing the button on the mobile app.

Standby Mode

To keep Model S ready to Summon and reduce the time it takes to warm up, turn on Standby Mode. Touch **Controls** > **Autopilot** > **Customize Summon** > **Standby Mode**. When Standby Mode is turned on, you can conserve Battery energy by disabling Standby Mode at these locations:

- **Exclude Home** - Disables Standby Mode at the location you set as Home in your Favorites list.
- **Exclude Work** - Disables Standby Mode at the location you set as Work in your Favorites list.
- **Exclude Favorites** - Disables Standby Mode at any location in your Favorites list.

NOTE: To conserve energy, Smart Summon automatically exits Standby mode from midnight to 6:00 am. During these hours, you will experience a delay as Smart Summon starts up.

NOTE: Additional battery power may be consumed while Standby Mode is active.

NOTE: For details on how to designate a location as Home, Work, or Favorites, see [Recent, Favorite, Home and Work Destinations on page 131](#)).

Stopping or Canceling Smart Summon

Smart Summon stops Model S whenever you release the button on the mobile app. To resume the Smart Summon session, simply press the **COME TO ME** or **GO TO TARGET** button again.

 **WARNING:** Always anticipate when you need to stop Model S. Depending on the quality of the connectivity between the phone and Model S, there may be a slight delay between when you release the button and when the car stops.

Smart Summon cancels, and requires you to restart it, when:

- You press any button on the key.
- A door handle is engaged or a door is opened.
- You interact with the steering wheel, brake pedal, accelerator pedal, or drive stalk.
- Model S is blocked by an obstacle.
- Smart Summon has moved Model S the maximum distance of approximately 145 meters within a 65 meter radius of the phone's location. To move further than this distance, you must shift Model S into a driving gear (Drive or Reverse) and then re-initiate an Smart Summon session.
- Your phone enters sleep mode or loses connectivity to Model S.

Limitations

Smart Summon is unlikely to operate as intended in the following types of situations:

- GPS data is unavailable due to poor cellular coverage.
- The driving path is sloped. Smart Summon is designed to operate on flat roads only (up to 10% grade).
- A raised concrete edge is detected. Depending on the height of the concrete edge, Smart Summon may not move Model S over it.
- One or more of the ultrasonic sensors or cameras is damaged, dirty, or obstructed (such as by mud, ice, or snow, or by a vehicle bra, excessive paint, or adhesive products such as wraps, stickers, rubber coating, etc.).
- Weather conditions (heavy rain, snow, fog, or extremely hot or cold temperatures) are interfering with sensor or camera operation.
- The sensors are affected by other electrical equipment or devices that generate ultrasonic waves.

NOTE: Smart Summon is disabled if Model S is in Valet mode (see [Valet Mode on page 38](#)).

 **WARNING:** The list above does not represent an exhaustive list of situations that may interfere with proper operation of Smart Summon. It is the driver's responsibility to remain in control of Model S at all times. Pay close attention whenever Smart Summon is actively moving Model S and stay prepared to take immediate action. Failure to do so can result in serious property damage, injury or death.

The Autopilot cameras and ultrasonic sensors monitor the markers on the lane you are driving in as well as the areas surrounding Model S for the presence of vehicles or other objects.

When an object is detected in your blind spot or near the side of Model S (such as a vehicle, guard rail, etc.), the instrument panel displays colored lines radiating from the image of your vehicle. The location of the lines correspond to the location of the detected object. The color of the lines (white, yellow, orange, or red) represent the object's proximity to Model S, with white being the farthest and red being the closest and requiring your immediate attention. These colored lines only display when driving between approximately 12 km/h and 140 km/h. When Autosteer is active, these colored lines also display if driving slower than 12 km/h. However, the colored lines do not display if Model S is at a standstill (for example, in heavy traffic).



CAUTION: Ensure all cameras and sensors are clean. Dirty cameras and sensors, as well as environmental conditions such as rain and faded lane markings, can affect Autopilot performance.

WARNING: Lane Assist features are for guidance purposes only and is not intended to replace your own direct visual checks. Before changing lanes, always use side mirrors and perform the appropriate shoulder checks to visually determine if it is safe and appropriate to change lanes.

WARNING: Never depend on Lane Assist to inform you if you unintentionally drive outside of the driving lane, or to inform you that there is a vehicle beside you or in your blind spot. Several external factors can reduce the performance of Lane Assist (see [Limitations and Inaccuracies on page 110](#)). It is the driver's responsibility to stay alert and pay attention to the driving lane and other road users. Failure to do so can result in serious injury or death.

Lane Departure Avoidance

Lane Departure Avoidance is designed to warn you if Model S is drifting out of, or nears the edge of, your driving lane.

Lane Departure Avoidance operates when driving between 64 and 145 km/h on roadways with clearly visible lane markings. You can choose if and how you want Lane Departure Warning to operate by touching **Controls > Autopilot > Lane Departure Avoidance** and selecting either of these options:

- **OFF:** You are not warned of lane departures or potential collisions with a vehicle in an adjacent lane.
- **WARNING:** If a front wheel passes over a lane marking, the steering wheel vibrates.
- **ASSIST:** Corrective steering is applied to keep Model S in a safe position if Model S drifts into an adjacent lane or near the edge of the roadway.

NOTE: Your setting is retained and saved to your Driver Profile until you manually change it.

When Lane Departure Avoidance is enabled and Model S drifts out of the driving lane when the associated turn signal is off and Traffic-Aware Cruise Control is active, the feature also checks to see whether your hands are on the steering wheel. If hands are not detected, the instrument panel displays a series of alerts, similar to those that are used when driving with Autosteer. If hands are repeatedly not detected Model S gradually slows down to 15 miles below the speed limit, or below the set cruising speed, and the hazard lights start flashing.

NOTE: Lane Departure Avoidance does not warn you of lane departures, or provide steering interventions, if the associated turn signal is on, which indicates an intentional lane change.

WARNING: Lane Departure Avoidance is intended to help keep you safe, but it does not work in every situation and does not replace the need to remain attentive and in control.

WARNING: Keep your hands on the steering wheel and drive attentively at all times.

WARNING: Steering interventions are minimal and are not designed to move Model S out of its driving lane. Do not rely on steering interventions to avoid side collisions.

Emergency Lane Departure Avoidance

Emergency Lane Departure Avoidance automatically applies steering to avoid a potential collision in situations where:



Lane Assist

- Model S is departing a lane and may collide with a vehicle traveling in the same direction in the adjacent lane (regardless of the status of the turn signal).
- Model S is departing a lane into an oncoming lane, the turn signal is off, and an oncoming vehicle is detected.
- Model S is departing the roadway and the turn signal is off (for example, very close to the edge of the road and a collision may occur).

To turn this feature on or off, touch **Controls** > **Autopilot** > **Emergency Lane Departure Avoidance**. Your setting is retained and saved to your Driver Profile until you manually change it.

When Emergency Lane Departure Avoidance applies steering, you will hear a chime and the instrument panel highlights the lane line in red and displays a warning.

Emergency Lane Departure Avoidance operates when Model S is traveling between 64 and 145 km/h on a roadway with clearly visible lane markings, curbs, etc.

 **WARNING:** Emergency Lane Departure Avoidance is not a substitute for attentive driving and sound judgment. Keep your eyes on the road when driving and never depend on Emergency Lane Departure Avoidance to prevent a collision. Several factors can reduce or impair performance. Depending on Emergency Lane Departure Avoidance to prevent a potential collision can result in serious injury or death.

Blind Spot Collision Warning Chime

If you want a chime to sound when a vehicle is in your blind spot and a possible collision is detected, touch **Controls** > **Autopilot** > **Blind Spot Collision Warning Chime**.

 **WARNING:** Blind Spot Collision Warning Chime cannot detect every collision. It is the driver's responsibility to remain alert and check their blind spots.

Adjacent Lane Speed

Due to market region and vehicle configuration, this feature may not be available on your vehicle.

When your vehicle is moving significantly faster than vehicles in adjacent lanes, Model S automatically reduces your driving speed. This is especially helpful in heavy traffic situations or when vehicles are constantly merging into different lanes. When Model S detects that other vehicles are driving significantly slower, the instrument panel highlights the adjacent lanes with arrows and detected vehicles in gray, slowing your vehicle down as appropriate. You can temporarily override this feature by pressing the accelerator pedal.

Never rely on Autopilot to determine a safe driving speed; you are responsible for the vehicle and obeying traffic laws.

Limitations and Inaccuracies

Lane Assist features cannot always detect lane markings and you may experience unnecessary or invalid warnings in these situations:

- Visibility is poor and lane markings are not clearly visible (due to heavy rain, snow, fog, etc.). The exact detection zone of the ultrasonic sensors varies depending on environmental conditions.
- Bright light (such as from oncoming headlights or direct sunlight) is interfering with the view of the camera(s).
- A vehicle in front of Model S is blocking the view of the camera(s).
- The windshield is obstructing the view of the camera(s) (fogged over, dirty, covered by a sticker, etc.).
- Lane markings are excessively worn, have visible previous markings, have been adjusted due to road construction, or are changing quickly (for example, lanes branching off, crossing over, or merging).
- The road is narrow or winding.
- Objects or landscape features are casting strong shadows on lane markers.

Lane Assist may not provide warnings, or may apply inappropriate warnings, in these situations:

- One or more of the ultrasonic sensors is damaged, dirty, or obstructed (such as by mud, ice, or snow).
- Weather conditions (heavy rain, snow, fog, or extremely hot or cold temperatures) are interfering with sensor operation.
- The sensors are affected by other electrical equipment or devices that generate ultrasonic waves.
- An object that is mounted to Model S is interfering with and/or obstructing a sensor (such as a bike rack or a bumper sticker).

In addition, Lane Assist may not steer Model S away from an adjacent vehicle, or may apply unnecessary or inappropriate steering, in these situations:

- You are driving Model S on sharp corners or on a curve at a relatively high speed.
- Bright light (such as from oncoming headlights or direct sunlight) is interfering with the view of the camera(s).
- You are drifting into another lane but an object (such as a vehicle) is not present.

- A vehicle in another lane cuts in front of you or drifts into your driving lane.
- Model S is not traveling within the speeds at which the Lane Assist feature is designed to operate.
- One or more of the ultrasonic sensors is damaged, dirty, or obstructed (such as by mud, ice, or snow).
- Weather conditions (heavy rain, snow, fog, or extremely hot or cold temperatures) are interfering with sensor operation.
- The sensors are affected by other electrical equipment or devices that generate ultrasonic waves.
- An object mounted to Model S (such as a bike rack or a bumper sticker) is interfering with or obstructing a sensor.
- Visibility is poor and lane markings are not clearly visible (due to heavy rain, snow, fog, etc.).
- Lane markings are excessively worn, have visible previous markings, have been adjusted due to road construction or are changing quickly (for example, lanes branching off, crossing over, or merging).

 **WARNING:** The lists above do not represent every possible situation that may interfere with Lane Assist features. There are many reasons why Lane Assist may not operate as intended. To avoid a collision, stay alert and always pay attention to the roadway so you can anticipate the need to take corrective action as early as possible.





Collision Avoidance Assist

If your Model S is equipped with Autopilot components (see [About Autopilot on page 79](#)), the following collision avoidance features are designed to increase the safety of you and your passengers:

- **Forward Collision Warning** - provides visual and audible warnings in situations when Model S detects that there is a high risk of a frontal collision (see [Forward Collision Warning on page 112](#)).
- **Automatic Emergency Braking** - automatically applies braking to reduce the impact of a frontal collision (see [Automatic Emergency Braking on page 113](#)).
- **Obstacle-Aware Acceleration** - reduces acceleration if Model S detects an object in its immediate driving path (see [Obstacle-Aware Acceleration on page 113](#)).

 **CAUTION:** Ensure all cameras and sensors are clean. Unclean cameras and sensors, as well as environmental conditions such as rain and faded lane markings, can affect Autopilot performance.

 **WARNING:** Forward Collision Warning is for guidance purposes only and is not a substitute for attentive driving and sound judgment. Keep your eyes on the road when driving and never depend on Forward Collision Warning to warn you of a potential collision. Several factors can reduce or impair performance, causing either unnecessary, invalid, inaccurate, or missed warnings. Depending on Forward Collision Warning to warn you of a potential collision can result in serious injury or death.

 **WARNING:** Automatic Emergency Braking is not designed to prevent all collisions. In certain situations, it can minimize the impact of a frontal collision by attempting to reduce your driving speed. Depending on Automatic Emergency Braking to avoid a collision can result in serious injury or death.

 **WARNING:** Obstacle-Aware Acceleration is not designed to prevent a collision. In certain situations, it can minimize the impact of a collision. Depending on Obstacle-Aware Acceleration to avoid a collision can result in serious injury or death.

Forward Collision Warning

The forward looking camera(s) and the radar sensor monitor the area in front of Model S for the presence of an object such as a vehicle, motorcycle, bicycle, or pedestrian. If a collision is considered likely unless you take immediate corrective action, Forward Collision Warning is designed to sound a chime and highlight the vehicle in front of you in red on the instrument panel. If this happens, **TAKE IMMEDIATE CORRECTIVE ACTION!**





Warnings cancel automatically when the risk of a collision has been reduced (for example, you have decelerated or stopped Model S, or the object in front of your vehicle has moved out of your driving path).

If immediate action is not taken when Model S issues a Forward Collision Warning, Automatic Emergency Braking (if enabled) may automatically apply the brakes if a collision is considered imminent (see [Automatic Emergency Braking on page 113](#)).

By default, Forward Collision Warning is turned on. To turn it off or adjust its sensitivity, touch **Controls > Autopilot > Forward Collision Warning**. Instead of the default warning level of **Medium**, you can turn the warning **Off**, or you can choose to be warned **Late** or **Early**.

NOTE: Your chosen setting for Forward Collision Warning is retained until you manually change it. It is also saved in your driver profile.

 **WARNING:** The camera(s) and sensors associated with Forward Collision Warning are designed to monitor an approximate area of up to 160 meters in your driving path. The area being monitored by Forward Collision Warning can be adversely affected by road and weather conditions. Use appropriate caution when driving.

 **WARNING:** Forward Collision Warning is designed only to provide visual and audible alerts. It does not attempt to apply the brakes or decelerate Model S. When seeing and/or hearing a warning, it is the driver's responsibility to take corrective action immediately.

 **WARNING:** Forward Collision Warning may provide a warning in situations where the likelihood of collision may not exist. Stay alert and always pay attention to the area in front of Model S so you can anticipate whether any action is required.

 **WARNING:** Forward Collision Warning operates only when driving between approximately 10 km/h and 150 km/h.

 **WARNING:** Forward Collision Warning does not provide a warning when the driver is already applying the brake.



Automatic Emergency Braking

The forward looking camera(s) and the radar sensor are designed to determine the distance from a detected object traveling in front of Model S. When a frontal collision is considered unavoidable, Automatic Emergency Braking is designed to apply the brakes to reduce the severity of the impact.

When Automatic Emergency Braking applies the brakes, the instrument panel displays a visual warning and sounds a chime. You may also notice abrupt downward movement of the brake pedal. The brake lights turn on to alert other road users that you are slowing down.

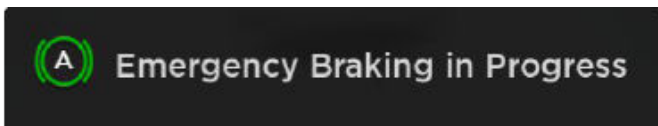

If driving (56 km/h) or faster, the brakes are released after Automatic Emergency Braking has reduced your driving speed by (50 km/h). For example, if Automatic Emergency Braking applies braking when driving 90 km/h, it releases the brakes when your speed has been reduced to 40 km/h.

Automatic Emergency Braking operates only when driving between approximately 10 km/h and 150 km/h.

Automatic Emergency Braking does not apply the brakes, or stops applying the brakes, when:

- You turn the steering wheel sharply.
- You press and release the brake pedal while Automatic Emergency Braking is applying the brakes.
- You accelerate hard while Automatic Emergency Braking is applying the brakes.
- The vehicle, motorcycle, bicycle, or pedestrian is no longer detected ahead.

Automatic Emergency Braking is always enabled when you start Model S. To disable it for your current drive, touch **Controls** > **Autopilot** > **Automatic Emergency Braking**.

 **WARNING:** It is strongly recommended that you do not disable Automatic Emergency Braking. If you disable it, Model S does not automatically apply the brakes in situations where a collision is considered likely.

 **WARNING:** Automatic Emergency Braking is designed to reduce the severity of an impact. It is not designed to avoid a collision.

 **WARNING:** Several factors can affect the performance of Automatic Emergency Braking, causing either no braking or inappropriate or untimely braking, such as when a vehicle is partially in the path of travel or there is road debris. It is the driver's responsibility to drive safely and remain in control of the vehicle at all times. Never depend on Automatic Emergency Braking to avoid or reduce the impact of a collision.

 **WARNING:** Automatic Emergency Braking is designed to reduce the impact of frontal collisions only and does not function when Model S is in Reverse.

 **WARNING:** Automatic Emergency Braking is not a substitute for maintaining a safe traveling distance between you and the vehicle in front of you.

 **WARNING:** The brake pedal moves downward abruptly during automatic braking events. Always ensure that the brake pedal can move freely. Do not place material under or on top of the Tesla-supplied driver's floor mat (including an additional mat) and always ensure that the driver's floor mat is properly secured. Failure to do so can impede the ability of the brake pedal to move freely.

Obstacle-Aware Acceleration

Obstacle-Aware Acceleration is designed to reduce the impact of a collision by reducing motor torque and in some cases applying the brakes, if Model S detects an object in its driving path. The instrument panel displays a visual warning and sounds a chime when the brakes are automatically applied. For example, Model S, while parked in front of a closed garage door with the Drive gear engaged, detects that you have pressed hard on the accelerator pedal. Although Model S still accelerates and hits the garage door, the reduced torque may result in less damage.

Obstacle-Aware Acceleration is designed to operate only when all of these conditions are simultaneously met:





- A driving gear is engaged (Drive or Reverse).
- Model S is stopped or traveling less than 10 mph (16 km/h).
- Model S detects an object in its immediate driving path.

To disable Obstacle-Aware Acceleration, touch **Controls** > **Autopilot** > **Obstacle-Aware Acceleration**.

 **WARNING:** Obstacle-Aware Acceleration is designed to reduce the severity of an impact. It is not designed to avoid a collision.



Collision Avoidance Assist

-  **WARNING:** Obstacle-Aware Acceleration may not limit torque in all situations. Several factors, including environmental conditions, distance from an obstacle, and a driver's actions, can limit, delay, or inhibit Obstacle-Aware Acceleration.
-  **WARNING:** Obstacle-Aware Acceleration may not limit torque when performing a sharp turn, such as into a parking space.
-  **WARNING:** Do not rely on Obstacle-Aware Acceleration to control acceleration or to avoid, or limit, the severity of a collision, and do not attempt to test Obstacle-Aware Acceleration. Doing so can result in serious property damage, injury, or death.
-  **WARNING:** Several factors can affect the performance of Obstacle-Aware Acceleration, causing an inappropriate or untimely reduction in motor torque and/or undesired braking. It is the driver's responsibility to drive safely and remain in control of Model S at all times.

Limitations and Inaccuracies

Collision Avoidance features cannot always detect all objects, vehicles, bikes, or pedestrians, and you may experience unnecessary, inaccurate, invalid, or missed warnings for many reasons, particularly if:

- The road has sharp curves.
- Visibility is poor (due to heavy rain, snow, fog, etc.).
- Bright light (such as from oncoming headlights or direct sunlight) is interfering with the view of the camera(s).
- The radar sensor is obstructed (dirty, covered, etc.).
- The windshield is obstructing the view of the camera(s) (fogged over, dirty, covered by a sticker, etc.).

 **WARNING:** The limitations previously described do not represent an exhaustive list of situations that may interfere with proper operation of Collision Avoidance Assist features. These features may fail to provide their intended function for many other reasons. It is the driver's responsibility to avoid collisions by staying alert, paying attention, and taking corrective action as early as possible.

 **CAUTION:** If a fault occurs with a Collision Avoidance Assist feature, Model S displays an alert. Contact Tesla Service.

How Speed Assist Works

Model S displays a speed limit on the instrument panel and you can choose if and how you are warned when you exceed the speed limit. Also, instead of using the detected speed limit, you can base warnings on an arbitrary speed limit that you enter manually.



In situations where Model S is unable to determine a speed limit, or if Speed Assist is uncertain that an acquired speed limit is accurate, the instrument panel may not display a speed limit sign and warnings do not take effect.

If you set the speed limit warning to **Display** (see [Controlling Speed Assist on page 115](#)) and exceed the determined speed limit, the speed limit sign on the instrument panel increases in size.

If you set the speed limit warning to **Chime** (see [Controlling Speed Assist on page 115](#)) and exceed the determined speed limit, the speed limit sign on the instrument panel increases in size and Model S also sounds a warning chime.

NOTE: Speed limit warnings go away after ten seconds, or when Model S slows down below the specified limit.

 **WARNING:** Do not rely on Speed Assist to determine the appropriate speed limit or driving speed. Always drive at a safe speed based on traffic and road conditions.

Controlling Speed Assist

To adjust the Speed Limit Warning setting, touch **Controls > Autopilot > Speed Limit Warning**, then choose one of these options:

- **Off** - Speed limit warnings do not display and chimes are not sounded.
- **Display** - Speed limit signs display on the instrument panel and the sign increases in size when you exceed the determined limit.
- **Chime** - In addition to the visual display, a chime is sounded whenever you exceed the determined speed limit.

You can also specify how the speed limit is determined:

- **Relative** - You can set a speed limit offset (+ or -) if you want to be alerted only when you exceed the offset speed limit by a specified amount. For example, you can increase the offset to +10 km/h if you only want to be warned when you exceed the speed limit by 10 km/h.

NOTE: The offset from speed limit also affects the number shown in the gray speedometer icon on the left side of the driving speed on the instrument panel.

- **Absolute** - Manually specify any speed limit between 30 and 240 km/h.

NOTE: Speed Assist is not always accurate. A road's location can be miscalculated and instead Speed Assist can display a speed for a directly adjacent road that may have a different speed limit. For example, Speed Assist can assume Model S is on a freeway or highway when it is actually on a nearby surface street, and vice versa.

NOTE: Your chosen setting is retained until you manually change it. It is also saved in your driver profile.

Limitations and Inaccuracies

Speed Assist may not be fully functional or may provide inaccurate information in these situations:

- Visibility is poor and speed limit signs are not clearly visible (due to heavy rain, snow, fog, etc.).
- Bright light (such as from oncoming headlights or direct sunlight) is interfering with the view of the camera(s).
- Model S is being driven very close to a vehicle in front of it which is blocking the view of the camera(s).
- The windshield is obstructing the view of the camera(s) (fogged over, dirty, covered by a sticker, etc.).
- Speed limit signs are concealed by objects.





Speed Assist

- The speed limits stored in the map database are incorrect or outdated.
- Model S is being driven in an area where GPS or map data is not available or where speed limit signs can not be detected.
- Traffic signs do not conform to standard recognizable formats.
- A road or a speed limit has recently changed.

 **WARNING:** The list above does not represent an exhaustive list of situations that may interfere with proper operation of Speed Assist. Speed Assist may fail to provide warnings for many other reasons.

Overview

	Touch Controls on the bottom corner of the touchscreen to control features and customize Model S to suit your preferences. The Controls window appears over the map. Touch an option on the left side of the window to display the associated controls and settings. By default, Quick Controls displays for quicker access to commonly used settings.
	To close the Controls window, touch the X in the top left corner, touch Controls again, or swipe down on the window.
	When an information icon displays beside a specific setting, touch it to display a popup that provides helpful details about the associated setting.

NOTE: The following illustrations are for demonstration purposes only. Depending on vehicle options, software version and market region, the options available may be different.

Summary of Controls

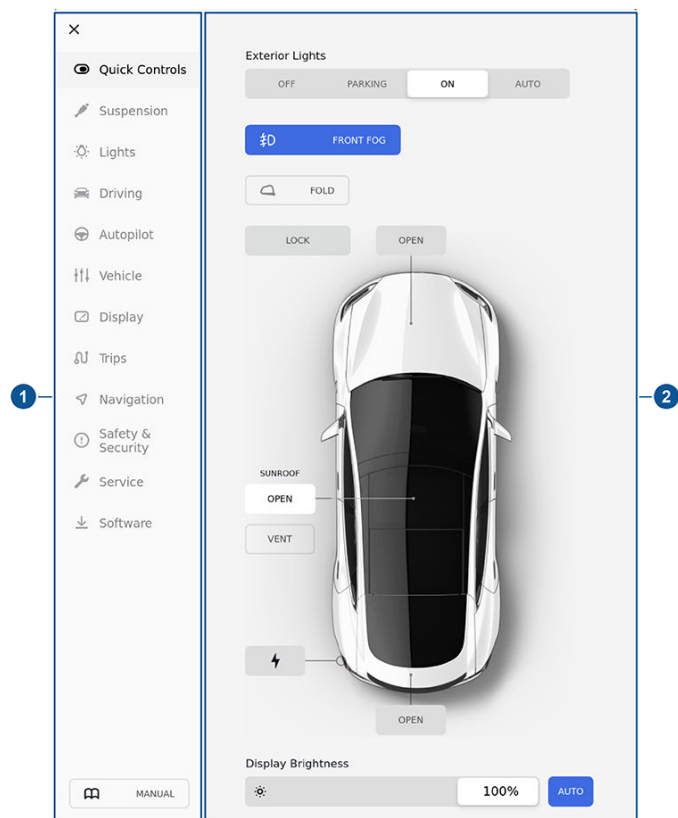





1. List of available controls. When you select an item from this list, its associated controls display in the main viewing area. Touch **Manual** below the list of tabs to display this owner's manual.
2. Main viewing area. The options available for the item you chose from the list of control tabs display here, and are described in this section.
NOTE: Depending on vehicle configuration and market region, some settings may not be available for your vehicle.

Quick Controls

Quick Controls displays by default to provide quick access to these commonly-used features. Additional controls for many of these features are available on the feature-specific tabs listed below Quick Controls.

• Exterior lights

	Exterior lights are off until you manually turn them back on. The exterior lights are set to AUTO by default at the start of every drive.
	The exterior side marker lights, parking lights, tail lights, and license plates lights turn on.
ON	Exterior lights are on.
	Exterior lights automatically turn on if Model S detects low lighting conditions.
	Enable/disable Auto High Beam, see High Beam Headlights on page 50 .

NOTE: For more information on exterior lights, see [Lights on page 48](#).

- **FRONT FOG** and **REAR FOG:** Controls the fog lights, if equipped (fog lights are only available in some market regions).
- **FOLD:** Fold or unfold side mirrors.
- **LOCK:** Touch to manually lock the vehicle.
- Touch **OPEN** to open the corresponding front trunk, rear trunk, or sunroof (if equipped). You can also touch **VENT** to partially open the sunroof (see [Sunroof on page 22](#)).
- **Charge Port:** Touch the button next to the charge port to open.
- **Display Brightness:** Adjust the brightness of the display.
- **Screen Clean Mode:** When enabled, your touchscreen darkens and is temporarily disabled to facilitate cleaning. Follow the onscreen instructions to exit Screen Clean Mode.

Suspension

Use these settings to adjust the settings associated with the air suspension system. You can adjust the **Ride Height**, ranging from **Low** to **Very High**. You can optimize ride and handling by choosing **Adaptive Suspension Damping** settings, view real-time details of the status of the suspension system, and save locations at which you want the ride height to automatically raise (helpful for increasing ground clearance on steep driveways, etc.) For details, see [Air Suspension on page 138](#).

Lights

Use these settings to control exterior and interior lights. Exterior light controls (**Exterior Lights**, **Front Fog**, and **Rear Fog**) are also available on the Quick Controls tab, and are described in the previous topic. For detailed information on lights, see [Lights on page 48](#). Using this tab, you can also control the following light settings:

- **Dome Lights:** Turn the overhead lights to OFF, ON, or AUTO. When set to AUTO, the dome lights automatically turn on when you unlock Model S, open a door upon exiting, or shift into Park.
- **Ambient Lights:** If on, the interior lights turn on whenever the headlights are on (if equipped).
- **Daytime Running Lights:** Toggle on if you would like you have your headlights on during the day time (if equipped).
- **Auto High Beam:** If on, the high beam headlights can automatically switch to low beam when there is light (for example, from an oncoming vehicle) detected in front of Model S. See [High Beam Headlights on page 50](#).
- **Headlights after Exit:** If on, the headlights remain on when you stop driving and park Model S in low lighting conditions. They automatically turn off after one minute or when you lock Model S.

Driving

Acceleration: (If equipped) Choose an acceleration setting that determines whether acceleration is limited or increased (see [Acceleration Modes on page 67](#)). **Chill** limits acceleration for a slightly smoother and gentler ride, whereas **Standard** or **Sport** (depending on vehicle configuration) provides the normal level of acceleration.

NOTE: When **Chill** is selected, **Chill** displays on the touchscreen above the driving speed.

Steering Mode: Adjust the amount of effort required to turn the steering wheel. **Sport** feels more responsive whereas **Comfort** feels easier to drive and park (see [Adjusting Steering Effort on page 39](#)).

Regenerative Braking: When you release the accelerator when driving, regenerative braking slows Model S and feeds any surplus energy back to the Battery. If set to **LOW**, Model S does not slow down as quickly, but also feeds less energy back to the Battery (see [Regenerative Braking on page 60](#)).

NOTE: Regardless of the setting selected, the energy gained by regenerative braking is reduced if the Battery is full, or is extremely cold or hot (in which case, surplus energy is used to heat or cool it).

NOTE: The regenerative braking setting is not available on all vehicles.

Stopping Mode: Choose how you want Model S to behave once regenerative braking has reduced the driving speed to a very low speed, a driving gear is still engaged, and both the accelerator and brake pedals are released. See [Stopping Mode on page 60](#). You can adjust this setting only when Model S is in Park.

Slip Start: Turn slip start on to allow wheels to spin (see [Traction Control on page 63](#)).

Range Mode (if equipped): If on, Model S conserves energy by automatically limiting the amount of power that the climate control system uses to maintain the temperature of the cabin area and limits the amount of energy being used to heat or cool the Battery. In addition, Range Mode turns off signature lights (only in market regions where daytime running lights are not required).

Autopilot

Control features that provide a safer and more convenient driving experience. Some Autopilot features are not controlled through **Controls**. See [About Autopilot on page 79](#) for more information.

- **Autosteer (Beta):** Enable the auto steering feature (available only if your vehicle is equipped with an Autopilot package) (see [Autosteer on page 87](#)).
- **Navigate on Autopilot (Beta):** Navigate on Autopilot automatically exits at off-ramps and interchanges based on your navigation route and can also make lane changes designed to prepare for exits and minimize the driving time to your destination (available only if your vehicle is equipped with an Autopilot package). Touch **Customize Navigate on Autopilot** to specify how you want Navigate on Autopilot to operate, such as whether you want it to automatically enable at the start of every trip, how you want it to perform lane changes, etc. (see [Navigate on Autopilot on page 91](#)).

NOTE: Navigate on Autopilot is not available in all market regions.

- **Traffic Light and Stop Sign Control (Beta)** (if equipped): You can enable the ability for Model S to automatically stop at traffic lights and stop signs (see [Traffic Light and Stop Sign Control on page 94](#)).

- **Green Traffic Light Chime:** If on, a chime sounds when you are waiting at a red traffic light and the light turns green. If you are not actively using Traffic-Aware Cruise Control and are waiting at a red light with a car in front of you, the chime sounds when the car advances ahead of you.
- **Full Self-Driving Visualization Preview** (if equipped) : Display more details about the roadway and its surroundings, such as road markings, stop lights, objects (such as trash cans and poles), etc. This may not be available on certain vehicle configurations or in some market regions.
- **Summon (Beta):** Automatically park and retrieve Model S from outside the vehicle (available only if your vehicle is equipped with an Autopilot package) (see [Summon on page 103](#)).

Customize Summon: Determine the bumper clearance, distance, amount of side clearance, and whether Summon requires continuous press when active.

- **Set Speed Offset:** When you engage Traffic-Aware Cruise Control or Autopilot to cruise at the speed limit (see [To Use Traffic-Aware Cruise Control on page 82](#)), you can choose a **FIXED** offset, in which the speed is adjusted by a specific number of km/h on all roads, or a **PERCENTAGE** offset, in which the speed adjustment varies depending on the detected speed limit of the road.
- **Speed Limit Warning:** Select the type of warnings, if any, you receive if you exceed the detected speed limit (see [Speed Assist on page 115](#)).
- **Speed Limit:** Specify if you want Speed Limit Warning to use a relative or an absolute speed limit (see [Speed Assist on page 115](#)). If you choose a relative speed limit, you can specify an **Offset** to be alerted only when you exceed the speed limit by the specified offset amount.
- **Forward Collision Warning:** Choose if and when you want to receive visual and audible warnings in situations where there is a high risk of a frontal collision (see [Collision Avoidance Assist on page 112](#)).
- **Lane Departure Avoidance (if equipped):** Specify if you want the steering wheel to vibrate slightly if a front wheel passes over a lane marking and the associated turn signal is off (see [Lane Assist on page 109](#)).
- **Emergency Lane Departure Avoidance (if equipped):** In emergency situations, Model S attempts to prevent a potential collision with an object in an adjacent lane by steering the vehicle back into your driving lane (see [Emergency Lane Departure Avoidance on page 109](#)).
- **Blind Spot Collision Warning Chime:** Choose if you want a chime to sound when a vehicle is in your blind spot and a possible collision is detected (see [Blind Spot Collision Warning Chime on page 110](#)).

- **Automatic Emergency Braking:** Specify if you want Model S to automatically apply braking when a frontal collision is imminent (see [Collision Avoidance Assist on page 112](#)).
- **Obstacle-Aware Acceleration:** Specify if you want to automatically reduce acceleration when an obstacle is detected in front of your vehicle while driving at low speeds (see [Collision Avoidance Assist on page 112](#)).

NOTE: Depending on market region, vehicle configuration, options purchased, and software version, your vehicle may not be equipped with all Autopilot features.

Vehicle

Driver Door Unlock Mode: If on, only the driver's door unlocks when you shift Model S into Park. If off, all doors unlock.

Auto-Present Handles: If on, door handles extend automatically as you approach Model S carrying a key. If off, you need to press the door handle to extend it.

Walk-Away Door Lock: If on, doors automatically lock when you walk away from the vehicle carrying your key (see [Walk-Away Door Lock on page 12](#)).

Car Left Open Notification: Choose whether you want Model S to send a notification to your Tesla mobile app if your car is open for an extended period (approximately 10 minutes) after you have left:

- **OFF** - you will not be notified if your car is left open.
- **DOORS** - you will be notified only if a door or trunk is left open.
- **DOORS & WINDOWS** - in addition to being notified if a door or trunk is left open, you will also receive a notification if Model S is locked and a window or sunroof (if equipped) is left open.

Touch the **Exclude Home** checkbox to disable the notification when Model S is parked at the location you set as Home in your Favorites list (see [Recent, Favorite, Home and Work Destinations on page 131](#)).

NOTE: To enable the **Car Left Open Notification**, the **Allow Mobile Access** setting must also be enabled.

NOTE: Notifications are not sent when Model S is in Camp Mode or if Tesla Theater (if equipped) is active.

Lock Confirmation Sound: You can set Model S to sound a soft horn when your car locks or unlocks (see [Keyless Locking and Unlocking on page 10](#)).

Unlock on Park: If on, doors automatically unlock when you engage the Park gear (see [Interior Locking and Unlocking on page 12](#)). If **Driver Door Unlock Mode** is on, only the driver's door unlocks.

Display

Customize characteristics of the touchscreen and instrument panel:

- **Display Mode:** Customize the DAY (light background) or NIGHT (dark background) setting. When set to AUTO, the brightness changes automatically between DAY and NIGHT brightness based on ambient lighting conditions.
- **Brightness:** Drag the slider to manually control the brightness level. When AUTO brightness is on, the touchscreen is further adjusted based on both the surroundings and by your learning preferences (for example, it remembers the type of manual adjustments you make).
- **Energy Saving:** When toggled on, Model S reduces the amount of energy being consumed when not in use (for newer vehicles, this is automated). See [Getting Maximum Range on page 71](#).

Customize how the units and language are displayed:

- **Language:** Select the language that is displayed on the touchscreen.
NOTE: Model S must be in Park to change the language. When you change the language, you experience a brief delay as the vehicle shuts down and restarts the touchscreen.
- **Voice Recognition Language:** Choose the language to be used for voice commands.
- **Navigation Language:** Choose the language that the navigation system uses for spoken instructions.
- **Time Format:** Choose if time is displayed in 12 or 24 hour format.
NOTE: To change the time if it is incorrect, press and hold the time displayed at the top of the touchscreen until it changes.
- **Energy Display:** Choose to display remaining energy and charging units as either a percentage of battery energy remaining, or as an estimate of the distance you can drive.
- **Distance:** Choose if miles or kilometers are used when displaying range.
- **Temperature:** Customize if temperature displays in Fahrenheit or Celsius.
- **Tire Pressure:** Select if tire pressures are displayed in BAR or PSI.

Trips

View and reset the trip meters that summarize how far you have driven (see [Trip Information on page 70](#)). Customize which meters to show in the instrument panel.

Navigation

Customize how the navigation system works by adjusting these settings:

- **Volume Control:** Increase or decrease the volume of spoken navigation instructions by touching - or +, respectively. Decreasing all the way to the left mutes the instructions. You can also mute navigation instructions when a navigation route is active by touching the volume icon on the turn-by-turn direction list.
NOTE: The volume setting applies only to the navigation system's spoken instructions. Volume for Media Player and Phone remains unchanged.
- **Automatic Navigation:** Provided your phone's calendar is synced to Model S, you are automatically routed to an event if you get into your vehicle within two hours of an event's start time (if the event on your calendar includes a valid address). Automatically navigate to Home and Work on weekdays (see [Automatic Navigation on page 129](#)).
- **Trip Planner:** (If available in your market region) Use trip planner to plan your driving and charging routes (see [Trip Planner on page 131](#)).
- **Online Routing:** When selected, you may be automatically rerouted to avoid heavy traffic (see [Online Routing on page 131](#)).
- **Avoid Ferries:** When toggled on, navigation routes avoid the use of ferries.
- **Avoid Tolls:** When toggled on, navigation routes avoid the use of tolls.

NOTE: You can also display navigation settings by touching the settings icon on the map (see [Maps and Navigation on page 128](#)).

Safety & Security

Parking Brake: You can manually apply and release the parking brake (see [Parking Brake on page 61](#)).

Power Off: Touch to manually power off the vehicle (see [Powering Off on page 44](#)).

Speed Limit Mode: Specify if and how much you want to limit acceleration and max speed (see [Speed Limit Mode on page 122](#)).

Sentry Mode: When on, Sentry Mode uses the vehicle's cameras and sensors to monitor its surroundings while the vehicle is locked and in Park. If a threat is detected, Sentry Mode triggers the Alert or Alarm state, depending on the severity of the threat. You can customize Sentry Mode to automatically enable except in locations that you've saved as Home, Work, or a Favorite (see [Sentry Mode on page 141](#)). Operates only when the energy remaining in the Battery is above 20%.

Save Clips on Honk: If on, you can save video recordings to a USB flash drive or other storage device using Dashcam by honking the horn on the steering wheel. You must insert a properly formatted USB flash drive or other storage device in one of your vehicle's front USB ports (see [Dashcam on page 74](#)).

Park Assist Chimes: If on, an audible beep sounds when approaching an object while parking (see [Park Assist on page 64](#)).

Joe Mode: When enabled, Joe Mode lowers the volume of your vehicle's chimes, except for turn signals.

Security Alarm: Enable the security alarm (see [Security Settings on page 141](#)).

Passive Entry: If on, doors automatically unlock and door handles extend (if Auto-Present Handles is on) whenever you approach Model S carrying a key. If off, you must use the key to unlock Model S. See [Using the Key on page 10](#).

NOTE: You must press the brake pedal to power Model S on before you can change the Passive Entry setting. See [Starting on page 44](#).

NOTE: If Passive Entry is off and you do not press the brake pedal to start Model S within approximately five minutes, a message displays on the instrument panel and you must use the key to lock, then unlock Model S again before starting the vehicle.

NOTE: When you enable passive entry, it is recommended that you also enable **PIN to Drive** to increase security (see [PIN to Drive on page 141](#)).

Tilt/Intrusion: If equipped, a siren can sound if Model S detects motion inside the cabin or if the vehicle is moved or tilted (see [Security Settings on page 141](#)).

PIN to Drive: Increase security by preventing Model S from being driven until a 4-digit PIN (Personal Identification Number) is entered (see [PIN to Drive on page 141](#)).

Glovebox PIN: For additional security, protect the contents in your glovebox with a 4-digit PIN (see [Glovebox PIN on page 141](#)).

Cabin Overheat Protection: Reduce the temperature of the cabin in extremely hot ambient conditions for a period of up to twelve hours after you exit Model S (see [Cabin Overheat Protection on page 127](#)). Operates only when the energy remaining in the Battery is above 20%.

Allow Mobile Access: Allow Tesla's mobile applications to access your Model S (see [Mobile App on page 150](#)).

NOTE: To disable Allow Mobile Access, enter your Tesla account credentials on the touchscreen.

DATA SHARING: Allow sharing of road measurement data (see [Data Sharing on page 194](#)).

Service

Key Fob Update: Your vehicle must be in Park to update your key fob. See [Using the Key on page 10](#) for more information.

Reset TPMS Sensors: Reset the TPMS sensors after replacing a wheel (see [Resetting the TPMS Sensors on page 164](#)).

Wheel Configuration: Update your vehicle's wheel configuration if you are installing new wheels or swapping them for different ones. This also changes the wheels of your vehicle's avatar on the touchscreen.

NOTE: Changing your vehicle's wheel configuration can impact range estimates, tire pressure warning levels, and vehicle visualization. See [Tire Care and Maintenance on page 162](#) for more information.

 **WARNING:** Only use Tesla-approved wheels when installing or swapping wheels. Using non Tesla-approved wheels can cause serious damage. Tesla is not liable for damage caused by using wheels not approved by Tesla.

Tow Mode: Prepare Model S for towing by keeping it in Neutral, which disengages the parking brake. See [Instructions for Transporters on page 189](#).

Wiper Service Mode: Make wiper blades easy to access (see [Wiper Blades and Washer Jets on page 170](#)).

Jack Mode: Disables self-leveling of the air suspension.

 **WARNING:** The air suspension system causes Model S to self-level, even when powered off. Therefore, when transporting or lifting, you must engage **Jack Mode** to disable self-leveling (see [Instructions for Transporters on page 189](#) and [Jacking and Lifting on page 174](#)).

Notifications: Display a list of notifications that have recently appeared on your vehicle.

Software Reinstall: In some rare situations in which a component has been replaced, a software reinstall may be needed. Touch to reinstall the existing software version. Existing settings are not affected. See [Software Reinstall on page 148](#).

Camera Calibration: Clear the Autopilot camera calibration to reset the calibrated camera positions and angles stored on the Autopilot computer. Once the calibration has been cleared, the vehicle must be driven to calibrate the Autopilot cameras. See [Drive to Calibrate Cameras on page 80](#) for more information.

FACTORY RESET: Erase all personal data (saved addresses, music favorites, imported contacts, etc.) and restore all customized settings to their factory defaults (see [Erasing Personal Data on page 122](#)).

Software

Learn more about your vehicle and the status of software updates:

- Get more information about your vehicle such as the VIN, vehicle name, and odometer. Touch **Additional vehicle information** to display a list of the various options your vehicle is equipped with. You can also display some of the vehicle information by touching the Tesla "T" at the top center of your touchscreen.
- View your current software version, map version, and release notes.
- See new updates that are available. Your vehicle must be connected to Wi-Fi to start the update.
- Customize how often you want to receive software updates by touching **Software Update Preferences**.

For more information about software updates, see [Software Updates on page 148](#).

Naming Your Vehicle

To further personalize Model S, you can name it. The name of your Model S appears in the mobile app. To name your vehicle, touch the Tesla "T" at the top center of the touchscreen, then touch **Name Your Vehicle** (or touch the vehicle's existing name). Enter the new name in the popup, then touch **Save**.

Speed Limit Mode

Speed Limit Mode allows you to limit the acceleration and maximum speed – between 50 and 90 mph (80 and 145 km/h) – of your Model S. This feature is protected by a 4-digit PIN that you create when enabling it for the first time, and which must be entered whenever you want to disable and enable it.

If your Model S comes within approximately 3 mph (5 km/h) of the selected maximum speed, a chime sounds and text appears on the instrument panel above the driving speed. Additionally, your mobile app sends you a notification.

To enable Speed Limit Mode:

1. Ensure the vehicle is in Park.
2. Touch **Controls > Safety & Security > Speed Limit Mode** on the touchscreen or **CONTROLS** in your mobile app.
3. Select the maximum driving speed that you would like to limit the vehicle to.
4. Drag the slider to the **ON** position.
5. Enter the 4-digit PIN that you want to use to disable and enable Speed Limit Mode.

NOTE: If you forget the PIN, you can disable Speed Limit Mode by entering the login credentials for your Tesla Account.

NOTE: When Speed Limit Mode is enabled, the acceleration setting (**Controls > Driving > Acceleration**) is automatically set to **Chill** (see [Acceleration Modes on page 67](#)).



WARNING: Driving downhill can increase driving speed, causing the vehicle to exceed your chosen maximum speed.



WARNING: Speed Limit Mode is not a replacement for good judgment, driver training, and the need to closely monitor roadway speed limits and driving conditions. Accidents can occur at any speed.

Erasing Personal Data

You can erase all personal data (saved addresses, music favorites, HomeLink programming, etc.) and restore all customized settings to their factory defaults. This is useful when transferring ownership of Model S. Touch **Controls > Service > FACTORY RESET**. Before erasing, Model S verifies your credentials by prompting you to enter the user name and password associated with your Tesla Account.

Overview of Climate Controls

Climate controls are always available at the bottom of the touchscreen. To turn the climate control system on, touch the fan icon or adjust the cabin temperature. To turn it off, touch the fan icon and then touch the off button near the center of the popup window.

By default, climate control is set to the Auto setting, which maintains optimum comfort in all but the most severe weather conditions. When you adjust the cabin temperature in the Auto setting, the system automatically adjusts the heating, air conditioning, air distribution, and fan speed to maintain the cabin at your selected temperature. To override the Auto setting, touch the fan icon, turn off the Auto setting, then manually adjust your settings (see [Adjusting Climate Control Settings on page 124](#)). If you've manually adjusted individual settings, you can also revert back to Auto at any time by touching **AUTO** on the climate control popup window.

NOTE: The following illustration is provided for demonstration purposes only. Depending on vehicle options, software version, market region, and settings, the information displayed may be slightly different.

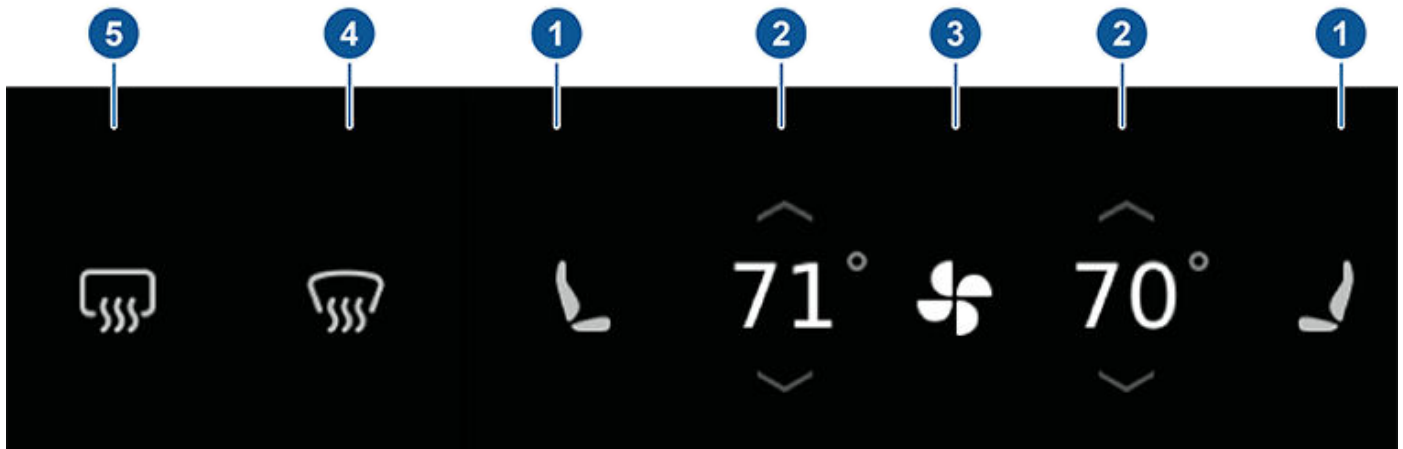

1. Seat heaters operate at three setting levels from 3 (highest) to 1 (lowest). When operating, the associated seat icon displays twisting lines that turn red to indicate the setting level. If equipped with ventilated seats, a popup appears that allows you to switch between heating and cooling. When cooling, the twisting lines turn blue.
NOTE: If Model S is equipped with rear seat heaters and/or the optional subzero weather package, you can also control seat heaters in the rear seats, heated wipers, and heated steering wheel by touching the fan icon then touching the seat tab.
2. Touch an up or down arrow to change the cabin temperature. To apply a temperature setting to both the driver and passenger side, touch **SYNC** on the popup that appears when you touch an arrow. When you apply the same temperature to both sides, only one temperature setting displays. Touch **SYNC** again to display separate temperature settings for the driver and passenger.
3. Touch the fan icon to turn on climate control and to manually customize settings to suit your preferences (see [Adjusting Climate Control Settings on page 124](#)). Touch and hold the fan icon to quickly turn off climate control. If your vehicle is equipped with the optional cold weather package, touch this icon to access controls for the rear seat heaters.
4. The windshield defroster distributes air flow to the windshield. Touch once to defog the windshield (the icon turns yellow). Touch a second time to defrost the windshield (the icon turns red and the heating and fan operate at maximum levels). Touch a third time to turn off and restore the air distribution, heating, and fan to their previous settings. See [Cold Weather Best Practices on page 77](#) for more information on preparing for cold weather.
5. Touch to warm up the rear window. When operating, the icon turns red. After 15 minutes, the rear window defroster automatically turns off. The exterior side mirrors are also heated whenever the rear window defroster is operating.

NOTE: Depending on date of manufacture and options selected at time of purchase, some vehicles are not equipped with a heater in the exterior side mirrors.



Climate Controls

WARNING: To avoid burns resulting from prolonged use, individuals who have peripheral neuropathy, or whose capacity to feel pain is limited because of diabetes, age, neurological injury, or some other condition, should exercise caution when using the climate control system and seat heaters.

NOTE: The climate control system is powered by the high voltage battery. Therefore, prolonged use decreases driving range.

Adjusting Climate Control Settings

To adjust individual settings to suit your preferences, touch the fan icon at the bottom of the touchscreen to access individual climate control settings.

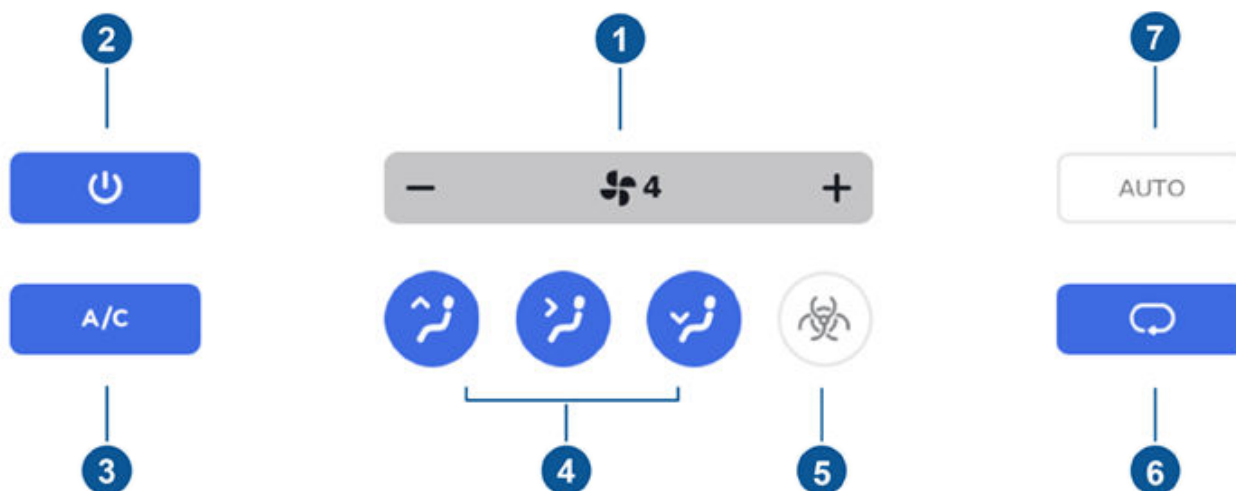

In addition to the settings shown, if Model S is in Park, the Keep Climate On, Dog Mode, and Camp Mode setting displays when you touch the fan icon when the vehicle is in Park (see [Keep Climate On, Dog Mode, and Camp Mode on page 126](#)).

1. Adjust the speed of the fan.

NOTE: Adjusting the fan speed may change your setting for how air is drawn into Model S in order to decrease or increase airflow. For example, if you set the fan speed at the highest setting when the air circulation is set to draw in outside air, the setting may switch to recirculating the air to achieve the high air flow.

2. Touch to turn off the climate control system and close the climate controls popup window.

NOTE: The popup window also closes if you touch the map, choose Media Player or an app, or display a controls window, even if the climate control system is turned on.

3. Turn the air conditioning on and off, respectively. Turning it off reduces cooling, but saves energy.
4. Choose where air flows into the cabin (windshield, face-level, or foot-level vents). You can choose more than one location.



NOTE: When air is directed to the foot-level vents, approximately one third of the air continues to flow to the windshield vents to assist in defogging. However, when air is directed to the face-level vents, air does not flow to the windshield because the air flowing through the face-level vents can assist in defogging the windshield.

5. If your Model S is equipped with the medical-grade HEPA (High Efficiency Particulate Air) filter, this filter ensures the best quality air inside the cabin whenever the climate control system is on and outside air is entering the cabin (i.e. recirculate is off). The HEPA filter is extremely effective at removing particles, including pollution, allergens, bacteria, pollen, mold spores, and viruses. Both the HEPA filter and the secondary filtration system also contain activated carbon to remove a broad spectrum of odors and gases. When you engage Bioweapon Defense Mode, the positive pressure inside the cabin minimizes the amount of outside air that can enter the vehicle.

NOTE: Some gases, such as carbon monoxide, are not effectively removed by activated carbon.



6. Choose how air is drawn into Model S:

	<p>Outside air is drawn into Model S (see Ventilation on page 126). Although less efficient than recirculating the air in very hot or cold climate conditions, this setting draws more air into the rear seating areas, and is recommended when occupants are seated in the Tesla built-in rear facing child seats.</p>
	<p>Air inside Model S is recirculated. This prevents outside air (traffic fumes) from entering, but reduces dehumidifying performance. Recirculating the air is the most efficient way to cool the front cabin area. To prevent the windshield from fogging in some conditions, briefly change the setting every hour to draw in outside air.</p>

7. Touch **AUTO** to change all settings back to their default values. The icon is blue whenever the climate control system is set to **AUTO**.

NOTE: Because Model S runs much quieter than a gasoline-powered vehicle, you may notice the sound of the A/C compressor as it is operating. To minimize noise, reduce the fan speed.



Climate Controls

Keep Climate On, Dog Mode, and Camp Mode

The **Keep Climate On**, **Dog**, and **Camp** settings allow you to keep the climate control system running when in Park, even after you've left Model S or choose to stay inside the vehicle. These settings are useful when it is important to maintain the cabin temperature in hot or cold weather conditions. For example, when leaving groceries in Model S on hot days, you may want to use Keep Climate On to prevent spoilage.

Dog mode keeps your pet comfortable while also displaying the current cabin temperature on the touchscreen so people nearby are informed that your pet does not need to be rescued.

Camp Mode allows you to power electronics through the USB ports and 12V outlet in addition to maintaining the cabin temperature. The touchscreen remains on so you can play music, browse the internet, play games in the arcade, or watch shows in Tesla Theater. You can also control media and climate settings from a paired phone. Camp Mode is ideal for remaining inside your vehicle, such as camping or staying with a child.

NOTE: In Camp Mode, Sentry Mode and the vehicle alarm system are disabled.

NOTE: Depending on vehicle configuration or market region, Entertainment, Arcade, and/or Theater may not be available on your vehicle.

To operate Keep Climate On, Dog Mode, or Camp Mode:

1. Engage the Park gear. The **Keep Climate On**, **Dog**, and **Camp** settings are available only when Model S is in Park.
2. If necessary, adjust the climate settings.
3. Touch the fan icon then touch **Keep Climate On**, **Dog**, or **Camp**.

NOTE: To initiate Keep Climate On, Dog Mode, or Camp Mode, the Battery's charge level must be at least 20%.

The climate control system maintains your climate settings until you shift out of Park or manually turn it off. If the Battery's charge level drops below 20%, the Tesla mobile app repeatedly starts sending you notifications reminding you to check on anything that you have left in Model S.

The next time you drive Model S, the climate control system continues operating using the previous climate settings from your most recent trip.

NOTE: Software updates cannot be performed when Keep Climate On, Dog Mode, or Camp Mode is active.

NOTE: The intrusion sensor (if equipped) automatically disables when Keep Climate On, Dog Mode, or Camp Mode is active. However, you can override this behavior and keep the intrusion sensor enabled. To do so, touch **Controls > Safety & Security > Tilt/Intrusion** after enabling Keep Climate On, Dog mode, or Camp mode. However, note that keeping the intrusion sensor enabled while Keep Climate On, Dog Mode, and Camp Mode is active can trigger an alarm event as a result of air movement inside the cabin.

WARNING: You can adjust the climate control system remotely using the mobile app. However, if you use the mobile app to turn off the climate control system, Keep Climate On, Dog Mode, and Camp Mode stop operating.

WARNING: Avoid using Keep Climate On, Dog Mode, or Camp Mode when the battery charge is low. When leaving a dog or pet in Model S, you must ensure that you have your phone with you and that the Tesla mobile app is running. This allows you to proactively monitor the cabin temperature. To ensure the safety and comfort of anyone or anything in your vehicle, always make sure you have adequate cellular coverage to receive notifications and allow enough time to return to Model S should the climate control system stop operating—on hot days, the cabin temperature can become dangerously high within a few minutes.

WARNING: Check local laws for any restrictions on leaving pets unattended in your vehicle.

WARNING: Never leave a child unattended in your vehicle.

Ventilation

Outside air is drawn into Model S through the grill in front of the windshield. Keep the grill clear of obstructions such as leaves and snow.

To direct the flow of air inside Model S, move the interior vents up, down, or from side to side.

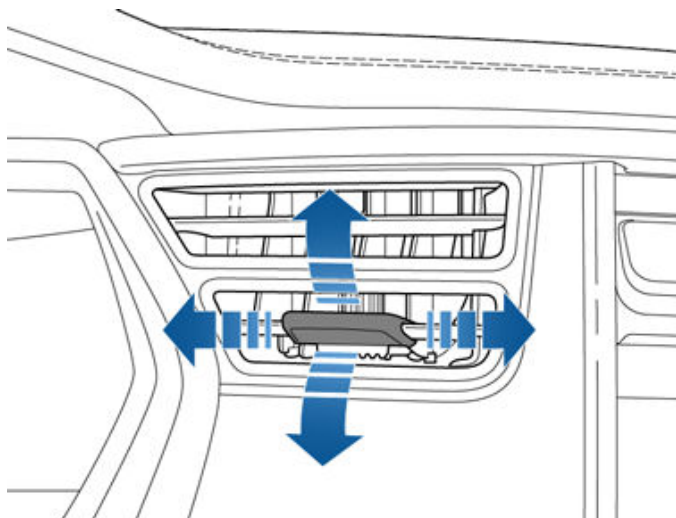



NOTE: You can direct the outer face level vents toward the side windows to help defrost or defog them.

Cabin Air Filter

Model S has an air filter that prevents pollen, industrial fallout, road dust and other particles from entering through the vents. Tesla recommends replacing the cabin air filter every 2 years.

Tesla recommends replacing the HEPA air filter (if equipped) every 3 years.

Cabin Overheat Protection

The climate control system can reduce the temperature of the cabin in extremely hot ambient conditions for a period of up to twelve hours after you exit Model S. Touch **Controls** > **Safety & Security** > **Cabin Overheat Protection** and choose:

- **OFF:** Disable Cabin Overheat Protection.
- **ON:** The air conditioning operates when the cabin temperature exceeds 40° C.

NOTE: Cabin Overheat Protection operates only when the energy remaining in the Battery is above 20%.



WARNING: Never leave children or pets in the vehicle unattended. Due to automatic shut-off or extreme outside conditions, the inside of the vehicle can become dangerously hot, even when Cabin Overheat Protection is enabled.

Climate Control Operating Tips

- When you use the mobile app to turn on the climate control system, it automatically turns off after four hours or if the charge level drops to 20%. To cool or heat the cabin for a longer period, you must turn it on again.
- To conserve energy, turn on Range Mode (if equipped) to limit the power of the climate control system (touch **Controls** > **Driving** > **Range Mode**). Cabin heating and cooling may be less effective, but you can use seat heaters to provide warmth in colder climates.
- If the climate control system is louder than you prefer, manually reduce the fan speed.
- In addition to cooling the interior, the air conditioning compressor also cools the Battery. Therefore, in hot weather, the air conditioning compressor can turn on even if you turned it off. This is normal because the system's priority is to cool the Battery to ensure it stays within an optimum temperature range to support longevity and optimum performance.

- Even when not in use, you may hear Model S emit a whining noise or the sound of water circulating. These sounds are normal and occur when the internal cooling systems turn on to support various vehicle functions, such as maintaining the 12V battery and balancing the temperature of the high voltage Battery.
- To ensure the climate control system operates efficiently, close all windows and ensure that the exterior grill in front of the windshield is free of ice, snow, leaves, and other debris.
- In very humid conditions, it is normal for the windshield to fog slightly when you first turn on the air conditioning.
- It is normal for a small pool of water to form under Model S when parked. Extra water produced by the dehumidifying process is drained underneath.
- To reduce the temperature in the cabin in hot weather conditions, the fan may turn on to vent the cabin when the vehicle is parked. This occurs only if the battery's charge level is above 20%.

Overview

The touchscreen displays a map at all times. To move the map in any direction, hold and drag a finger. To rotate the map in any direction, hold and turn two fingers.

To set the map's orientation, touch the icon in the top right corner of the map:

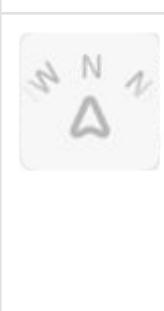

	<p>North Up - North is always at the top of the screen.</p>
	<p>Heading Up - The direction you are driving is always at the top of the screen. The map rotates as you change direction. This icon has an integrated compass that indicates the direction you are driving.</p> <p>NOTE: When navigating, this icon also allows you to view the route overview view (see Navigating on page 129).</p>



When you rotate or move the map, your current location is no longer tracked. The message "Tracking Disabled" displays briefly next to the map orientation icon and the icon turns gray. To re-enable tracking, touch the map's orientation icon to choose North Up or Heading Up.

Touch the + and - icons to zoom the map in and out on your current or chosen location. When you zoom in or out using these icons, tracking remains enabled.

Touch the following icons to customize what the map displays and to access navigation settings:

NOTE: These icons disappear after a few seconds when not in use. Touch anywhere on the map to re-display them.

	<p>Display/hide satellite imagery (if equipped with premium connectivity).</p>
	<p>Display/hide traffic conditions (if equipped with premium connectivity). Green lines indicate no traffic; orange lines indicate light traffic; red lines indicate moderate traffic; and pink lines indicate heavy traffic. To ensure traffic is easy to identify along a navigation route, green traffic lines display under the blue route line, whereas orange, red, and pink traffic lines display on top of the blue route line.</p>

	<p>Display/hide all charging locations and a popup list that includes the city and proximity of the corresponding stations on the map. Charging locations include Tesla Superchargers, Tesla destination chargers, third party fast chargers (see note below), and public chargers that you have used previously. See Charging Locations on page 130.</p> <p>NOTE: In some market regions, third party fast chargers are also included on the map as dark grey pins when you display chargers.</p> <p>NOTE: The map always displays Superchargers, even when you hide charging locations.</p>
	<p>Increase or decrease the volume of spoken navigation instructions by touching - or +, respectively. Decreasing all the way to the left mutes the instructions. You can also mute navigation instructions when a navigation route is active by touching the volume icon on the turn-by-turn direction list.</p> <p>Customize how the navigation system works by adjusting these settings (the available settings vary depending on your market region and vehicle configuration):</p> <ul style="list-style-type: none"> • Touch Trip Planner to minimize the time you spend driving and charging (see Trip Planner on page 131). • Touch Online Routing to be automatically rerouted to avoid heavy traffic (see Online Routing on page 131). • Touch Avoid Ferries to be automatically routed to avoid ferries. • Touch Avoid Tolls to be automatically routed to avoid tolls. <p>NOTE: You can also access the above navigation settings by touching Controls > Navigation.</p> <p>NOTE: The volume setting applies only to the navigation system's spoken instructions. Volume for Media Player and Phone remains unchanged.</p>

Drop a pin by pressing and holding your finger anywhere on the map. When you drop a pin, or touch an existing pin, the chosen location is centered on the map, and a popup window provides information about the location. From this popup, you can navigate to the location, call the location (if a phone number is



available) and add or remove the location from your list of favorite destinations (see [Recent, Favorite, Home and Work Destinations on page 131](#)).

Navigating

To navigate to a location, touch **Navigate**, send the destination from your phone, or speak a voice command (see [Using Voice Commands on page 40](#)). You can enter or speak an address, landmark, business, etc. You can also choose a saved **Home** or **Work** location and select from a list of recently used locations (the most recent displays at the top of the list), including charging stations you have visited.

NOTE: To remotely start navigation from your iOS® or Android™ device, use the "share" functionality after giving access to the Tesla mobile app.



When you specify a location, the touchscreen zooms out to provide an overview of the route you need to travel, and, after calculating the route, zooms back in to your starting point and begins to provide instructions. A turn-by-turn direction list displays the first navigation instruction and an estimate of total mileage, driving time, and arrival time. To expand the list to show each turn on your navigation route, touch the instruction. Note the following about the turn-by-turn direction list:

- A battery displays below the destination to provide an estimate of how much battery energy will remain when you reach your destination. Touch to expand battery information to show a round trip estimate back to your starting point. See [Predicting Energy Usage on page 130](#).
- If charging is needed to reach your destination and Trip Planner is enabled (and available in your market region), the navigation route automatically includes Supercharger stops (see [Trip Planner on page 131](#)) and you may need to touch **BEGIN TRIP** to initiate navigation.
- If you won't have enough energy to reach your destination and there is no Supercharger on the route, an alert tells you that charging is needed to reach your destination.
- Each turn is preceded by the distance to the maneuver.
- To see the bottom of the list, you may need to drag the list upward.
- Touch the top of the list again to minimize it.

While navigating, the map tracks your location and displays the current leg of your trip. You can display the entire route at any time.

If Navigate on Autopilot (if available in your market region) is enabled, you can turn it on for the navigation route by touching **Navigate on Autopilot** in the turn-by-turn direction list. Navigate on Autopilot is an extension of Autosteer that automatically changes lanes and steers

Model S onto the appropriate exit(s) when navigating on controlled access roads (such as freeways). For details, see [Navigate on Autopilot on page 91](#).

	<p>The route overview icon displays when a navigation route is active. Touch this icon at any time to view an overview of your navigation route, or to change the orientation of the map (see Overview on page 128), which also zooms the map to show the current leg of your trip. The black pin at the end of the route line represents your destination.</p>
	<p>Mute/unmute navigation volume.</p> <p>NOTE: You can also mute the volume of the navigation system by pressing the scroll button on the left side of the steering wheel while navigation instructions are being spoken. A volume control specific to navigation instructions is also available by touching the settings icon on the map (see Overview on page 128).</p>

To stop navigating, touch **CANCEL**, located below the turn-by-turn direction list.

NOTE: If a data connection is not available, onboard maps allow you to navigate to any location, but you must enter the location's exact and complete address.

Automatic Navigation

Automatic Navigation can predict a destination when you get in your vehicle. When your phone's calendar is synced to Model S, and the calendar includes an event that takes place within two hours of when you get in your vehicle to drive, Automatic Navigation suggests the location of the event (assuming a valid address is associated with the event).

In addition, if you are Home and get in your vehicle on weekdays (Monday to Friday) from 5:00 AM to 11:00 AM, Automatic Navigation can automatically route you to your specified Work location (see [Recent, Favorite, Home and Work Destinations on page 131](#)). Likewise, if you are at work on weekdays from 3:00 PM to 11:00 PM, Automatic Navigation can automatically route you to your specified Home location.

To enable Automatic Navigation, touch **Controls > Navigation > Automatic Navigation**. You must have your phone's calendar correctly synced to your vehicle with a uniquely specified and valid address for each event (see [Calendar on page 140](#)). Your Automatic Navigation settings are saved to your Driver Profile (see [Driver Profiles on page 37](#)).

NOTE: Navigation instructions that you enter manually, or send to Model S, override routes suggested by Automatic Navigation.



Maps and Navigation

NOTE: Availability of this feature depends on market region and vehicle configuration.

I'm Feeling Lucky, Hungry



In addition to navigating to a destination of your choice, Model S can also suggest nearby locations based on whether you are feeling **Hungry** or **Lucky**. In the navigation search bar, touch **Hungry** or **Lucky**. **Hungry** suggests popular restaurants, whereas **Lucky** suggests popular destinations (such as museums and amusement parks). For a new suggestion, go back and touch **Hungry** or **Lucky** again for different results. When you discover a destination that interests you, touch **Navigate** to proceed to the destination.

This feature requires the latest version of Navigation maps. To download, connect your vehicle to Wi-Fi and navigate to **Controls > Software** to check if an update is available (see [Map Updates on page 132](#)).

NOTE: Availability of this feature depends on market region and vehicle configuration.

Charging Locations

The map always displays Supercharger locations, represented by red pins that you can touch to display more information, navigate to it, or mark it as a favorite. The appearance of the pin itself reveals information about the Supercharger location:

	<p>The Supercharger location is operational. At locations with multiple Superchargers, a row of bars displays above the icon, with each bar representing a Supercharger. If a Supercharger is in use, the bar is filled in to provide a quick visual that indicates how many Superchargers are currently being used at the location. Superchargers that may be out of order in addition to the number available are also displayed.</p> <p>NOTE: A Supercharger pin is colored black if located on your current navigation route.</p>
	<p>The Supercharger location may be out of operation or is operating at a reduced capacity. Touch the pin to display details.</p>

When you touch the pin for a Supercharger location, a popup displays information, including the total number of Superchargers, the number of Superchargers available, the address of the Supercharger location, and its approximate distance from your current location.

The popup also displays amenities that are available at the Supercharger location, including restrooms, restaurants, lodging, shopping, and Wi-Fi.

Touch the map's charging icon to display all nearby charging stations of the map. In addition to the Superchargers, the map displays Tesla's destination chargers, third party fast chargers (see note below), and any public charging stations that you have previously used. Display details about a charging location by touching its pin. You can also filter the types of chargers shown based on max power.

NOTE: In some market regions, third party fast chargers are also included as dark grey pins when you choose to display all charging stations on the map.



The location is equipped with a Tesla Wall Connector. Touch to display more information such as usage restrictions and available charge current. The charging list also displays your proximity to these charging stations.

NOTE: When the map is zoomed out and more than one Tesla Wall Connector is available in an area, the pin is round and displays the number of stations. Touch the pin to zoom in. Then you can touch an individual pins for details about a specific charging location.

NOTE: When navigating to a Supercharger or, in some regions, a third-party fast charger location, Model S may allocate energy to pre-heat the Battery. This ensures you arrive at the Supercharger or third-party fast charger with the optimal Battery temperature, reducing the amount of time it takes to charge. In some circumstances (such as cold weather), it is normal for the front motor to make noise as it generates heat to warm the Battery (see [Warming the Battery Before Supercharging on page 78](#)).

Predicting Energy Usage

When navigating to a destination, Model S helps you anticipate your charging needs by calculating the amount of energy that remains when you reach your destination. The calculation is an estimate based on driving style (predicted speed, etc.) and environmental factors (elevation changes, temperature, etc.). When navigating, the map displays this calculation at the bottom of the expanded turn-by-turn direction list (see [Navigating on page 129](#)). When the turn-by-turn direction list is compressed, touch the top of the list to expand it.

Throughout your route, Model S monitors energy usage and updates the calculation. A popup warning displays at the bottom of the turn-by-turn direction list in these situations:



- A yellow warning displays when you have very little energy remaining to reach your destination and should drive slowly to conserve energy. For tips on conserving energy, see [Getting Maximum Range on page 71](#).
- A red warning displays when you must charge to reach your destination.

If you also want to know if you have enough energy for a round trip, touch the energy calculation to display an estimate of your round trip energy usage.

Online Routing

Model S detects real-time traffic conditions and automatically adjusts the estimated driving and arrival times based on traffic. In situations where traffic conditions will delay your estimated time of arrival and an alternate route is available, the navigation system can reroute you to your destination. To turn this feature on or off, touch the map's settings icon (see [Overview on page 128](#)), then touch **Online Routing**. You can also specify the minimum amount of minutes that must be saved before you are rerouted by touching the arrows associated with the **Re-Route if it saves more than** setting.

Trip Planner

Trip Planner (available in some market regions) helps you take longer road trips with confidence. If reaching your destination requires charging, Trip Planner routes you through the appropriate Supercharger locations. Trip Planner selects a route and provides charging times to minimize the amount of time you spend driving and charging. To enable Trip Planner, touch the map's settings icon (see [Overview on page 128](#)), then touch **Trip Planner**.

When Trip Planner is enabled and charging is required to reach your destination, the turn-by-turn direction list includes Supercharger stops and a recommended charging time at each Supercharger, and an estimate of how much energy will be available when you arrive at the Supercharger.

NOTE: When navigating to a Supercharger or, in some regions, a third-party fast charger using Trip Planner, your vehicle may allocate some energy to pre-heat the Battery. The vehicle arrives at the Supercharger or third-party fast charger with an optimal Battery temperature, reducing the amount of time it takes to charge (see [Warming the Battery Before Supercharging on page 78](#)).

To remove Supercharger stops and display only directions, touch **Remove charging stops** at the bottom of the list of directions (if you remove charging stops, the turn-by-turn direction list may display an alert indicating that charging is needed to reach your destination). To add Supercharger stops to the directions, touch **Add charging stops**.

While charging at a Supercharger, the charging screen displays the remaining charging time needed to drive to your next Supercharger stop, or destination (if no further charging is needed). If you charge for a shorter or longer length of time, the charging time for subsequent Supercharger stops is adjusted.

NOTE: You can also monitor remaining charging time needed in the Tesla Mobile App.

NOTE: If a Supercharger located on your route experiences an outage, Trip Planner displays a notification and reroutes you to a different Supercharger location.

If Trip Planner estimates that you won't have enough energy for your round trip, and there are no Superchargers available on your route, Trip Planner displays an alert at the top of the turn-by-turn direction list notifying you that charging is needed to reach your destination.

Recent, Favorite, Home and Work Destinations

When you touch **Navigate** on the map, a list of **Recent** destinations appear and you can easily navigate to any recent destination by selecting it from the list.

If you frequently drive to a destination, you may want to add it as a favorite to avoid having to enter the location's name or address each time. When you add a destination as a Favorite, you can easily navigate to it by touching **Navigate > Favorites** and then selecting it from the list of favorites.

	<p>To add a destination to your Favorites list touch its pin on the map, then touch the heart icon on the popup window that appears. You will be prompted to name the Favorite. Enter a name (or leave as-is to accept the default name), then touch Add to Favorites. The heart becomes solid gray and the destination is included on the Favorites list.</p>
---	---

To delete a Recent or Favorite destination, touch and hold it down briefly, then touch the **X** that appears.

The top of the navigation list also provides shortcuts for **Home** and **Work** locations. Touch **Set Home** or **Set Work** to set an address to either of these locations. After entering the address, touch **SAVE AS HOME** or **SAVE AS WORK**. Then simply touch these shortcuts whenever you want to navigate home or to work.

To change the location associated with Home or Work, press and hold the shortcut icon and enter the new desired address in the "Set Your Home Address" window. Then, touch **SAVE AS HOME** or **SAVE AS WORK** to save the new address.



Maps and Navigation

To delete a saved Home or Work address, press and hold the shortcut icon, and then touch **CLEAR HOME** or **CLEAR WORK**.

NOTE: Based on your usage patterns, you may be prompted to save a location as Home or Work.

NOTE: Once a Home or Work location is saved, Model S may prompt you to navigate to your Work location in the mornings and to your Home location in the evenings and tell you how long it will take to arrive based on current traffic conditions.

For security reasons, if you sell Model S, it is recommended that you delete your Home and Work Locations. You can delete these individually or you can perform a factory reset to erase all personal data (see [Erasing Personal Data on page 122](#)).

Map Updates

As updated maps become available, they are automatically sent to Model S over Wi-Fi. To ensure you receive them, periodically connect Model S to a Wi-Fi network (see [Connecting to Wi-Fi on page 147](#)). The touchscreen displays a message informing you when new maps are installed.



Overview



Touch the Media Player icon at the bottom of the touchscreen to play various types of media through your vehicle's speaker system. The media options available to you depend on market region and options chosen at time of purchase. For example, you can stream internet radio or podcasts (if equipped with premium connectivity), listen to AM (if equipped), FM radio. You can also play audio files from a Bluetooth or USB-connected device.

Media Player provides three different levels of viewing that you can access by dragging the Media Player window upward or downward. Initially, just the Miniplayer displays. The Miniplayer, which occupies the least amount of space on the touchscreen, displays what's currently playing and provides only the basic functions, mostly associated with what's playing. Drag upward to display Recents and Favorites and access the icons you can use to change your media source (described next). Drag upward again to browse through all available options for the chosen type of source content.

Use the icons across the bottom of Media Player to change your media source (for example, FM, Streaming, or a Bluetooth-connected device). Use the tabs on the left to narrow down the type of content you want to browse through—the associated content displays on the right. For Radio, you can browse through Favorite Stations or you can touch **Direct Tune** to enter the frequency of a specific channel. For Streaming, you can browse through Favorites, Top Stations, DJ Series, and Genres.

Volume Control

Roll the scroll button on the left side of the steering wheel up or down to increase or decrease volume respectively. The scroll button adjusts the volume for media, navigation instructions, or phone calls, based on what is currently being heard through the speakers. You can also adjust the volume by touching the arrows associated with the speaker icon on the bottom of the touchscreen.

To mute the volume, press the left scroll button. Press again to unmute.

NOTE: Pressing the left scroll button during a phone call mutes both the sound and your microphone.

NOTE: If you're playing media and you receive a phone call, or the navigation system is speaking directions, the volume of what you are listening to is temporarily muted.

Searching Media Content



Touch Media Player's magnifying glass icon to search for a particular song, album, artist, podcast, or station. Select a filter to narrow the scope of your search, or leave it at its default setting to include top results from all available source content.

NOTE: Use voice commands to search hands-free (see [Using Voice Commands on page 40](#)).

AM (if equipped) and FM Radio



If available in your market region and location, Media Player provides AM and FM radio stations that you can select from the Radio source. Touch the next or previous arrows to move from one frequency to the next (or previous). Or touch **Direct Tune** to enter a specific frequency.

For easy access to radio stations you listen to frequently, mark it as a favorite so it's readily available in your Favorites list (see [Favorites and Recents on page 134](#)).

Internet Radio and Music Streaming Services (if equipped)

If equipped with premium connectivity, internet radio and music streaming services are available over a data connection. To listen, touch the Media Player icon and choose the streaming service you want to listen to.

You can use your Tesla account or you can sign in with your own account by scrolling to the bottom of the streaming service window and entering your account credentials.

Browse through the available categories and/or stations, then touch what you want to play. When browsing through a large category such as genres, you may need to drag the window upward to enlarge it and view more available options. When you choose an option that displays multiple results on a new window, touch **BACK** at the top of the window to return to the main browse page.

You can also use voice commands to play a specific song, artist, or album from an Internet radio service (see [Using Voice Commands on page 40](#)).

When listening to internet radio or a music streaming service, the options available on Miniplayer can vary depending on what you are listening to:



Media and Audio

- Touch the next (or previous) arrows to play the next (and in some cases previous) available station, episode, or track being provided by the Internet radio service.
- Like or dislike a song or podcast. When you like a song, for example, the radio station plays similar songs. When you dislike a song, the song won't be played again.
- Touch the **DJ** icon (if available) to include commentary for the content you are streaming. DJ commentary includes music history and behind-the-scenes stories.

NOTE: When playing a podcast (if available), you can rewind or fast forward to any location in the show. On the Miniplayer, drag the slider to the desired location or touch the rewind/fast forward icons to move back or forward 15 seconds at a time.

Caraoke



In addition to various streaming services, your vehicle is equipped with Caraoke. To access Caraoke, touch the Music icon near the bottom of the touchscreen. You can browse through various songs and select the song you want to sing. Touch the microphone icon to enable or disable the song's main vocals. Disabling the microphone leaves only the song's instrumentals and background vocals. Touch the lyrics icon (located next to the microphone icon) to enable or disable the song's lyrics.

NOTE: Depending on vehicle configuration and market region, Caraoke may not be available on your vehicle.

WARNING: Never read Caraoke lyrics while driving. You must always pay attention to the road and traffic conditions. When driving, the Caraoke lyrics are intended only for use by a passenger.

Favorites and Recents

For most source content, your favorites display at the top of Media Player's expanded view for easy access.

	To add a currently playing station, podcast, or audio file to your Favorites list, touch the Favorites icon on Miniplayer.
	To remove an item as a favorite, touch the highlighted Favorites icon on Miniplayer. You can also remove multiple favorites by expanding Miniplayer one level to show all favorites for the applicable type of source content. Then press and hold any favorite. An X

appears on all favorites and you can then touch the **X** to remove it from your Favorites list.

To see selections that you have recently played, scroll up one level from Miniplayer and touch **Recent**. Your recently played selections are updated continuously so you don't need to remove them.

NOTE: Selections you play on FM radio are not included in your Recent list.

Playing Media from Devices

	You can play audio files from a Bluetooth-connected device (like a phone) or a USB-connected flash drive. When you connect a Bluetooth-capable device, the name of the device displays when you choose the Phone source. When you connect a USB flash drive, Media Player displays the driver's source content.
---	---

To play the next song in a selected playlist or album, touch the previous or next arrows on Miniplayer, or use the buttons on the left side of the steering wheel (see [Using Left Steering Wheel Buttons on page 39](#)). You can also shuffle tracks in a playlist or repeat a playlist or track using the shuffle/repeat icons (if available).

USB Connected Flash Drives

Connect a flash drive to a front USB connection (see [USB Ports on page 19](#)). Touch **Media Player** > **USB**, and then touch the name of the folder that contains the song you want to play. After you display the contents of a folder on the USB connected flash drive, you can touch any song in the list to play it. Or use the previous and next arrows in Miniplayer to scroll through your songs.

NOTE: To play media from a USB connection, Model S recognizes flash drives only. You can play media from other types of devices (such as an iPod) by connecting the device using Bluetooth.

NOTE: Media Player supports USB flash drives with FAT32 formatting (NTFS and exFAT are not currently supported).

Bluetooth Connected Devices

If you have a Bluetooth-capable device such as a phone that is paired and connected to Model S (see [Pairing a Bluetooth Phone on page 136](#)), you can play audio files stored on it and you can stream music from it. Choose Media Player's **Phone** source, then touch the name of your Bluetooth-connected device, and then touch **CONNECT**.



Your Bluetooth device begins playing the audio file that is currently active on your device, and Media Player displays the Miniplayer view. If no audio file is playing on your device, use your device to choose the audio file you want to listen to. When the chosen file begins to play, you can then use Miniplayer's next and previous icons to play other tracks.

NOTE: To play media from a Bluetooth-connected device, ensure that access to the device's media is turned on (see [Pairing a Bluetooth Phone on page 136](#)).

Audio Settings



Press the settings icon at the bottom corner of Media Player to access audio settings for tone and balance. Other settings may be available based on your vehicle's manufacture date, features, and market region. For example, your vehicle may be equipped with options that you can turn on or off, such as Dolby Surround and DJ Commentary.

To adjust any of the five frequency bands (Bass, Bass/Mid, Mid, Mid/Treble, and Treble) drag the corresponding slider up or down the decibel (dB) bar.

To adjust balance, touch **Balance** and drag the center circle of the cross bars to the location in Model S where you want to focus the sound.

Bluetooth® Compatibility

You can use your Bluetooth-capable phone hands-free in Model S provided your phone is within operating range. Although Bluetooth typically supports wireless communication over distances of up to approximately 9 meters, performance can vary based on the phone you are using.

Before using your phone with Model S, you must pair it. Pairing sets up Model S to work with your Bluetooth-capable phone (see [Pairing a Bluetooth Phone on page 136](#)).

You can pair up to ten Bluetooth phones. Model S always automatically connects to the last phone that was used (provided it is within range). If you want to connect to a different phone, see [Connecting to a Paired Phone on page 136](#).

NOTE: On many phones, Bluetooth turns off if the phone's battery is low.

NOTE: In addition to phones, you can also pair Bluetooth-enabled devices with Model S. For example, you can pair an iPod Touch or an iPad or Android tablet to stream music.

Pairing a Bluetooth Phone

Pairing allows you to use your Bluetooth-capable phone hands-free to make and receive phone calls, access your contact list, recent calls, etc. It also allows you to play media files from your phone. Once a phone is paired, Model S can connect to it whenever the phone is within range.

To pair a phone, follow these steps while sitting inside Model S:

1. Ensure both the touchscreen and the phone are powered on.
2. On your phone, enable Bluetooth and ensure it is discoverable.
NOTE: On some phones, this may require you to go to Bluetooth Settings for the remainder of the procedure.
3. Touch the Bluetooth icon on the top of the touchscreen.
4. On the touchscreen, touch **Add New Device > Start Search**. The touchscreen displays a list of all available Bluetooth devices within operating distance.
5. On the touchscreen, touch the phone with which you want to pair. Within a few seconds, the touchscreen displays a randomly generated number, and your phone should display the same number.
6. Check that the number displayed on your phone matches the number displayed on the touchscreen. Then, on your phone, confirm that you want to pair.

7. If prompted on your phone, specify whether you want to allow Model S to access your contacts and media files.

When paired, Model S automatically connects to the phone, and the touchscreen displays the Bluetooth symbol next to the phone's name to indicate that the connection is active.

At any time, you can display the Bluetooth settings screen to change settings associated with a connected device. For example, you can designate a connected phone as the **Priority Device**. This is useful in situations where you have connected more than one phone, and both phones are frequently used in Model S at the same time. Model S automatically attempts to connect to the priority device before others.

Importing Contacts and Recent Calls

Once paired, you can use the Bluetooth settings screen (touch the Bluetooth icon on the touchscreen's top status bar) to specify whether you want to allow access to your phone's contacts and recent calls. If access is turned on, you can use the phone app to display, and make calls to, people in your list of contacts and on your recent calls lists (see [Using the Phone App on page 137](#)).

NOTE: Before contacts can be imported, you may need to either set your phone to allow syncing, or respond to a popup on your phone to confirm that you want to sync contacts. This varies depending on the type of phone you are using. For details, refer to the documentation provided with your phone.

NOTE: You can turn access to your contacts and recent calls on or off at any time by displaying the Bluetooth settings screen, choosing the phone, and then changing the setting associated with contacts and recent calls.

Unpairing a Bluetooth Phone

If you want to disconnect your phone and use it again later, simply touch **Disconnect** on the Bluetooth settings screen. If you do not want to use your phone with Model S again, touch **Forget This Device**. Once you forget a device, you need to pair it again if you want to use it with Model S (see [Pairing a Bluetooth Phone on page 136](#)).

NOTE: Your phone automatically disconnects whenever you leave Model S.

Connecting to a Paired Phone

Model S automatically connects to a phone that you designated as **Priority Device** on the Bluetooth settings screen. If you have not set a phone as a priority, Model S connects to the last phone to which it was connected, provided it is within operating range and has Bluetooth

turned on. If the last phone is not within range, it attempts to connect with the next phone that it has been paired with.

To connect to a different phone, touch the Bluetooth icon on the top of the touchscreen. The Bluetooth window displays a list of paired phones. Choose the phone you want to connect to, then touch **Connect**. If the phone you want to connect to is not listed, you must pair the phone. See [Pairing a Bluetooth Phone on page 136](#).

When connected, the Model S touchscreen displays the Bluetooth symbol next to the phone name to show that the connection is active.

Using the Phone App

When your phone is connected to Model S using Bluetooth, and you have allowed access to your phone's contacts (see [Importing Contacts and Recent Calls on page 136](#)), you can use the phone app to display and make a hands-free call to anyone listed on your phone:

- **Recent Calls** list. The list displays calls in chronological order with the most recent call listed first. You can display all calls or just those that are missed, incoming, or outgoing.
- **Contacts**: Contacts are listed in alphabetical order and can be sorted by first name or last name. You can also choose a letter on the right side of the list to quickly scroll to the names that begin with the selected character. When you touch a name on your contacts list, the contact's available number(s) displays on the right pane, along with other available information (such as address). Touch the contact's number to make a call.

You can also view, send, and receive text messages on the touchscreen. Instead of typing a text message, touch the microphone to enter text using your voice.

 **WARNING:** To minimize distraction and ensure the safety of vehicle occupants as well as other road users, do not view or send text messages when the vehicle is in motion. Pay attention to road and traffic conditions at all times when driving.

Making a Phone Call

You can make a phone call by:

- Speaking a voice command (English) (see [Using Voice Commands on page 40](#)).
- Selecting a contact or recent call from the menu on your right scroll button (see [Using Right Steering Wheel Buttons on page 40](#)).
- Choosing a number from your contact or recent calls list in the phone app.
- Using the Model S on-screen dialer in the phone app.

NOTE: If it is safe and legal to do so, you can also initiate a call by dialing the number or selecting the contact directly from your phone.

NOTE: You can also make a phone call by touching a pin on the map and choosing the phone number (if available) on the popup window.

Receiving a Phone Call

When your phone receives an incoming call, the instrument panel and touchscreen display the caller's number or name (if the caller is in your phone's contact list and Model S has access to your contacts).

Touch one of the options on the touchscreen, or roll the scroll button on the right side of the steering wheel to **Answer** or **Ignore** the call (see [Using Right Steering Wheel Buttons on page 40](#)).

NOTE: Depending on the phone you are using and what speakers you used for your most recent call, your phone may prompt you to choose which speakers you want to use for the incoming call.

 **WARNING:** Stay focused on the road at all times while driving. Using or programming a phone while driving, even with Bluetooth enabled, can result in serious injury or death.

 **WARNING:** Follow all applicable laws regarding the use of phones while driving, including, but not limited to, laws that prohibit texting and require hands-free operation at all times.

In Call Options

When a call is in progress, you can display the call menu on the instrument panel by pressing the top button on the right side of the steering wheel. Then roll the right scroll button and choose an option (see [Using Right Steering Wheel Buttons on page 40](#)). To adjust the call volume, roll the steering wheel's left scroll button during a call.



Air Suspension

NOTE: When Model S starts, you may hear the sound of the compressor as the air suspension system's reservoir fills with air.

Your Model S is equipped with Adaptive Air Suspension that offers superior ride quality and allows you to choose a softer or firmer ride based on your preference. When carrying loads, the system also maintains a level height between the front and rear. You can manually adjust the ride height to suit your circumstances (for example, you can raise Model S when driving at low speeds when you need extra ground clearance, such as when driving on a steep driveway or ramp, in deep snow, over large speed bumps, parking curbs, etc.). You can also specify a default ride height when driving at higher speeds.

	If a fault is detected that reduces the performance of the air suspension system, a yellow indicator lights up on the instrument panel. If the problem persists, contact Tesla.
	If a fault is detected that disables the air suspension system, a red indicator lights up on the instrument panel. Contact Tesla.

Adjusting Ride Height

CAUTION: Before adjusting the suspension height, ensure Model S is clear of all obstacles, above and below.

You can manually adjust the ride height by pressing the brake pedal and touching **Controls > Suspension** on the touchscreen. The ride height settings that are available depend on your driving speed and other conditions (for example, the suspension does not lower if a door is open). The touchscreen also displays the approximate ground clearance for each setting. Drag the slider to choose from these options:

- **VERY HIGH.** When set to Very High, the suspension automatically lowers to the default ride height* (Standard or Low) after driving approximately 30 meters or when driving speed reaches 24 km/h. To maintain the Very High setting for an unlimited distance until your driving speed reaches the speed threshold, touch **Keep until 24 km/h.**
- **HIGH.** When set to High, the suspension automatically lowers to the default ride height* (Standard or Low) after driving approximately 30 meters or when driving speed reaches 56 km/h. To maintain the High setting for an unlimited distance until your driving speed reaches the speed threshold, touch **Keep until 56 km/h.**
- **STANDARD.** The Standard setting ensures optimum comfort and handling under all loading conditions.

- **LOW.** Lowering the height can improve aerodynamics and make it easier to load or unload cargo and passengers.

*As described in the list above, Model S automatically adjusts the ride height based on your driving speed. If the **DEFAULT RIDE HEIGHT IS LOW** setting is turned off, the ride height is adjusted between Standard and Low to balance ride comfort, handling, and range. To optimize handling and range, turn on the **DEFAULT RIDE HEIGHT IS LOW** setting.

CAUTION: Avoid driving aggressively (hard accelerations, sharp turns, etc.) when the suspension is set to **High** or **Very High**. Doing so can cause vibration and increase the possibility of damage.

Adaptive Suspension Damping

The settings associated with **ADAPTIVE SUSPENSION DAMPING** provide real-time adjustments to the suspension system to optimize both ride and handling. Choose from:

- **COMFORT:** provides a gentler ride for a relaxed driving experience.
- **AUTO:** adjusts to a wide range of roads and driving styles, providing a fluid yet well controlled ride.
- **SPORT:** provides a firmer, more controlled ride that increases driver engagement and connection to the road.
- **ADVANCED:** Fine tune the suspension by dragging individual sliders to adjust **Ride Comfort** and **Handling**.

NOTE: Your chosen Adaptive Suspension Damping settings are saved to your driver profile (see [Driver Profiles on page 37](#)).

Real-time Visualization

The image of your Model S on the Suspension screen provides a real-time visualization of the status of the air suspension system. In addition to visually showing changes to the ride height, it displays Compression and Rebound lines that reflect how the suspension system is controlling the dampers for each wheel based on your chosen settings and changing road conditions. Both are controlled simultaneously. Touch **Show Suspension Data** to display detailed information about the dampers for each wheel, including ride height, compression and rebound values, and body accelerations.



NOTE: The instrument panel can also display a real-time visualization of how the suspension system is dynamically adjusting each wheel's damping to account for changing road conditions. To view, hold the respective steering wheel scroll button briefly until the available options are displayed. Roll the scroll button to highlight **Suspension**, then tap the scroll button.

Auto-Raising Suspension

Auto-raising suspension saves you from manually having to raise the suspension every time you arrive at a frequently-used location where you have previously raised the suspension. Whenever you raise the suspension to **HIGH** or **VERY HIGH**, you can touch **Always Auto-Raise at This Location** to save the location. When you return to the saved location, Model S raises the suspension and the instrument panel displays a message indicating that the suspension is being raised.

NOTE: When returning to a saved location and driving faster than the High and Very High suspension settings allow, the suspension does not raise until Model S slows down.

NOTE: After leaving a saved location, the suspension automatically lowers. However, it may not lower until you are driving faster than the speed threshold at which the suspension lowers.

NOTE: If Model S reaches a saved location and the existing suspension setting is already higher than the level that has been saved for that location, the ride height is not adjusted.

To remove an auto-raising location

If you do not want the suspension to auto-raise at a saved location, touch the **X** in the auto-raising location status message that displays at a saved location. Doing so removes the auto-raise location and the suspension no longer raises automatically when you arrive at the location.

Self-Leveling

A Model S equipped with air suspension automatically self-levels, even when power is off. To prevent damage when jacking or lifting the vehicle, you must activate Jack Mode to disable self-leveling (press the brake pedal and touch **Controls** > **Service** > **Jack Mode**). For more details, see [Jack Mode on page 174](#).

Overview

The Calendar app allows you to view scheduled events from your phone's (iPhone® or Android™) calendar for the current and next day. The Calendar is conveniently integrated with navigation and the Phone app so you can navigate to, or dial into, your next meeting. The Calendar app requires that:

- The Tesla mobile app is running, you are logged in, and the Calendar Sync setting is enabled. The mobile app can then periodically (and automatically) send calendar data from your phone to Model S.

NOTE: To ensure you have access to all features of the Calendar app, it is recommended that you use the most recent version of the mobile app.

- Your phone is connected to Model S via Bluetooth (for privacy reasons, calendar data displays only from a connected phone).
- Mobile access to Model S is turned on (touch **Controls > Safety & Security > Allow Mobile Access**).
- Both your phone and Model S have good connectivity.

When you enter Model S, the touchscreen can display a reminder of the day's events. You can customize if and when your calendar events are displayed by touching the settings icon located in the top left corner of the Calendar app, then choosing from one of the options available for the **Show Calendar Upon Entry** setting.

If a calendar event includes an address, a navigation arrow displays to indicate that you can touch the address to navigate to the event's location (if equipped with Navigation).

If an event has a uniquely specified address and takes place within two hours of you entering your vehicle and preparing to drive, Model S will automatically route you to the event's address (see [Automatic Navigation on page 129](#)).

Touch an event's information icon to display all notes associated with the event. If the notes include one or more phone numbers, the information icon shows a phone icon and the calendar displays the first phone number found. Touch to initiate a phone call. You can also initiate a phone call by touching any number in an event's notes popup window (this is especially useful for conference calls). If the notes contain a web link, you can touch the link to open it in the web browser (if equipped).

If events are displayed from multiple calendars, touch the list icon in the top right corner to filter the list of events to show only those from one or more specified calendars.



About the Security System

If Model S does not detect a key nearby and a locked door or trunk is opened, an alarm sounds and the headlights and turn signals flash. To deactivate the alarm, press any button on the key.

To manually enable or disable the alarm system, touch **Controls > Safety & Security > Security Alarm**. When enabled, Model S activates its alarm one minute after you exit, the doors lock, and a recognized key is no longer detected.

If your Model S is equipped with the security package, a battery-backed siren sounds in situations where a locked door or trunk is opened and Model S does not detect a key nearby. If you also want this siren to sound in situations where Model S detects motion inside the cabin, or is moved or tilted (for example, with a tow truck or jack), turn on the **Tilt/Intrusion** setting (**Controls > Safety & Security > Tilt/Intrusion**).

NOTE: If you plan to leave something that moves inside your locked Model S, remember to turn off **Tilt/Intrusion** (if equipped). If this setting is on, any motion detected inside Model S activates the intrusion alarm.

NOTE: Note: If Model S is in Sentry Mode (see [Sentry Mode on page 141](#)), you must disable Sentry Mode before you can disable the Security alarm or the Tilt/Intrusion alarm.

NOTE: The **Security Alarm** must be on to enable **Tilt/Intrusion**.

NOTE: The Intrusion Sensor automatically disables in situations where the climate control system is operating when you have left your vehicle (see [Keep Climate On, Dog Mode, and Camp Mode on page 126](#)). To override, you can manually turn the Intrusion Sensor on again after choosing Keep Climate On, Dog, or Camp Mode (touch **Controls > Safety & Security > Tilt/Intrusion**).

PIN to Drive

To increase security, you can prevent Model S from being driven until a 4-digit PIN (Personal Identification Number) is entered. To enable this setting, touch **Controls > Safety & Security > PIN to Drive** and follow the on-screen prompts to create a driving PIN.

NOTE: When enabled, in addition to entering the 4-digit driving PIN to drive, you must also use it to enter Valet mode for the first time and create the 4-digit valet PIN that you can use to enter and exit Valet mode. When in Valet mode, Model S can be driven without the need for the valet to enter a driving PIN. In addition, the **PIN to Drive** setting is disabled whenever Valet mode is active.

If you forget your driving PIN, or to disable **PIN to Drive**, return to this setting, touch the link to enter your Tesla login credentials, then follow the on-screen prompts.

NOTE: In the unlikely event that your touchscreen is unresponsive, you may be unable to enter the PIN. In this case, first try to restart the touchscreen (see [Restarting the Touchscreen on page 44](#)). If the touchscreen is still unresponsive, you can still bypass PIN to Drive by turning on Keyless Driving in the Tesla mobile app.

Glovebox PIN

For additional security, you can protect the contents in your glovebox with a 4-digit PIN (Personal Identification Number). To enable this setting, touch **Controls > Safety & Security > Glovebox PIN** and follow the on-screen prompts. When enabled, you are prompted to enter the PIN to open the glovebox. To disable this setting, return to **Safety & Security**, select the toggle to disable and then enter the PIN.

If you forget your glovebox PIN, reset it by entering your Tesla login credentials, then follow the on-screen prompts.

NOTE: When you open the glovebox with both **Glovebox PIN** and Valet mode enabled, you are prompted for the glovebox PIN and taken out of Valet mode after the glovebox opens.

Sentry Mode

In Sentry Mode, cameras and sensors remain powered on and ready to record suspicious activity whenever Model S is locked and in Park.

To turn Sentry Mode on or off, touch the Sentry Mode icon at the top of your touchscreen. Alternatively, you can use voice commands, the mobile app, or you can touch **Controls > Safety & Security > Sentry Mode**. To activate Sentry Mode using voice commands, say "Keep Tesla safe", "Keep my car safe", "Sentry on", or "Enable Sentry" (for details using voice commands, see [Using Voice Commands on page 40](#)).

NOTE: Sentry Mode requires the Battery to be at least 20% charged. If the Battery falls below 20%, Sentry Mode turns off and the mobile app sends you a notification.

NOTE: Power consumption may increase when Sentry Mode is active.

NOTE: Software updates cannot be installed when Sentry Mode is activated.



CAUTION: Do not rely on Sentry Mode to protect Model S from all possible security threats. While it may help deter some threats, no security system can prevent all attacks.



CAUTION: Sentry Mode may not trigger the security alarm in all situations involving damage to the vehicle. The security alarm depends upon multiple factors to be triggered and may not detect all impacts to the vehicle or may not trigger the alarm in all cases.



Security Settings

Standby, Alert, and Alarm States

When in Sentry Mode, Model S may go through three states depending on its surroundings—Standby, Alert, and Alarm:

- **Standby** - Your vehicle automatically enters the Standby state when you activate Sentry Mode. In the Standby state, the cameras constantly monitor the area surrounding Model S for possible security threats.
- **Alert** - If Sentry Mode detects a threat, such as someone leaning on, or very close to, Model S, Sentry Mode switches to the Alert state. The headlights briefly turn on and back off again, and the touchscreen displays a message indicating that cameras are recording the event.
- **Alarm** - For major threats, Sentry Mode triggers the Alarm state. In the Alarm state, the security alarm activates and the audio system generates a loud and unexpected sound. Sentry mode sends an alert to the mobile app on phones that are paired to Model S to inform you that the alarm state is triggered. After 30 seconds, Sentry Mode returns to the Standby state.

When in the Alert or Alarm state, Sentry Mode saves the most recent ten minutes of footage prior to the event that triggered either state, provided that a properly configured USB flash drive is inserted into one of the USB ports. For details on how to configure a flash drive, see [USB Flash Drive Requirements for Videos and Recording on page 143](#).

NOTE: When the Alarm state is triggered, the most recent six seconds prior to the security event may be sent to Tesla for temporary backup for approximately 72 hours. You can enable or disable the collection of this video at any time by touching **Controls > Safety & Security > Data Sharing**.

NOTE: Sentry Mode can operate without a flash drive installed. If your vehicle enters the Alarm state, the security alarm activates and Sentry Mode sends an alert to your phone. However, video recordings of the event are not available.

Location-Based Settings

You can customize Sentry Mode to automatically activate at specific locations where you park Model S:

- **Exclude Home** - When on, Sentry Mode does not automatically activate at the location you set as Home in your Favorites list (see [Recent, Favorite, Home and Work Destinations on page 131](#)), but activates at any other parking location.

NOTE: To set up your Home location, touch **Navigate** and hold down **Home**, then enter your address. Touch **Save as Home**.

- **Exclude Work**- When on, Sentry Mode does not automatically activate at the location you set as Work in your Favorites list, but activates at any other parking location. Set your Work location the same way you set up your Home location, as previously described.
- **Exclude Favorites**- When on, Sentry Mode does not automatically activate at any location in your Favorites list, but activates at any other parking location.

To recognize a location listed as Home, Work, or a Favorite, Sentry Mode requires that Model S is parked within 10 meters of the location listed as a Home, Work, or Favorite.

NOTE: Manually enabling or disabling Sentry Mode using the icon on the touchscreen or controls in the mobile app will override your home, work, and favorite exclusion preferences until the next time you drive your vehicle.

Retrieving Footage

If equipped, you can review Dashcam and Sentry Mode video recordings on your vehicle's touchscreen when Model S is in Park. Touch the Dashcam icon on the touchscreen's status bar and select **Launch Viewer**. Each video, organized by location and timestamp, provides a thumbnail of all video clips. For additional filtering, touch the **Dashcam** or **Sentry** tabs. Touch a thumbnail to view the corresponding video footage from each camera. Pause, rewind, fast forward, and delete video footage as needed.

You can retrieve video footage from the USB flash drive by removing the flash drive from the USB port and using a personal computer or other device to access the files. Navigate to the **TeslaCam** folder.

The **TeslaCam** folder contains three sub-folders:

- **Recent Clips** - The footage in Recent Clips continuously loops in 60-minute cycles whenever the cameras are activated. Therefore, footage is overwritten every hour unless you save it. When an event is recorded, one video is recorded for each of the front, rear (available on vehicles manufactured after approximately February 2018), left, and right cameras.
- **Saved Clips** - Contains all recordings that you have manually saved using Dashcam.
- **Sentry Clips** - Contains the last 10 minutes of footage from all Sentry Mode events that have triggered an Alert or Alarm state. The footage from each event is labelled with a unique timestamp.



NOTE: As the USB flash drive runs out of available space, the oldest footage in Sentry Clips is deleted to make room for new footage. Once deleted, you are unable to retrieve them. When the flash drive is full, Sentry Mode and Dashcam can no longer save video footage. To prevent the flash drive from getting full, you must regularly move saved videos to another device, and delete them from the flash drive.

NOTE: Dashcam recording is paused when the viewer is open.

NOTE: You are responsible for complying with all local laws, regulations, and property restrictions regarding video recordings.

NOTE: The cameras do not record audio.

USB Flash Drive Requirements for Videos and Recording

To store video from your vehicle's cameras, follow these requirements and guidelines for choosing, preparing, and using flash drives:

- The flash drive must have a **sustained** write speed of at least 4 MB/s. A sustained write speed is different from the peak write speed. Check the product details of your flash drive for more information.
- The flash drive must be USB 2.0 compatible. If using a USB 3.0 flash drive, it must be able to support USB 2.0.
- Use a flash drive with as much available storage as possible. Video footage can occupy a large amount of space. Tesla recommends using a flash drive with at least 32 GB of storage. Some personal computer operating systems may be unable to format flash drives larger than 32 GB as FAT 32. Consider using a third party application to format flash drives larger than 32 GB.
- The flash drive must be properly formatted (described below).
- Use a dedicated flash drive exclusively for saving Sentry Mode recordings.

Although not a comprehensive list, Tesla has tested the following flash drives and confirmed that they meet the requirements for using Dashcam and Sentry Mode:

- SanDisk Ultra Fit USB 3.1 Flash Drive
- Samsung MUF-64AB/AM FIT Plus - 200MB/s USB 3.1 Flash Drive

Formatting a USB Flash Drive

To correctly save and retrieve video footage, Model S requires the USB flash drive to be formatted as exFAT, FAT 32 (for Windows), MS-DOS FAT (for Mac), ext3, or ext4. NTFS is currently not supported. In addition, the USB flash drive must contain a base-level folder called "TeslaCam" (without quotation marks).

You can format a USB flash drive from inside Model S or from a personal computer.

To format a flash drive from inside Model S, simply insert a USB flash drive into a front USB port, and touch **Safety & Security > FORMAT USB DEVICE**. Doing so formats the drive as exFAT and automatically creates a **TeslaCam** folder. The USB flash drive is now ready to record and save video footage.



CAUTION: The **FORMAT USB DEVICE** button is available whenever a USB Flash Drive (with one or fewer partitions) is plugged into a front USB port. Choosing **FORMAT USB DEVICE** formats the drive, erasing all existing content. If you have content on a drive that you want to keep, you must move it to a different device before using this feature.

To format a USB flash drive from a personal computer, follow the steps below for your operating system.

For MacOS:

1. Insert the USB flash drive into your personal computer.
2. Navigate to **Utilities > Disk Utility** (or conduct a Spotlight Search).
3. Select your flash drive in the left menu.
4. Navigate to **Erase** in the top menu ribbon.
5. In the pop-up menu, select the correct format (MS-DOS FAT) and click **Erase**.

NOTE: Selecting **Erase** removes all existing content from your flash drive. If you have content that you want to keep, you must move it to a different device before erasing.

6. Once the flash drive is successfully erased, navigate to **Finder** and select your USB flash drive from the left menu. The flash drive should not contain any files.
7. Right-click in the empty space of the flash drive and select **New Folder**. A folder appears in your flash drive space.
8. Right-click on the folder, select **Rename**, and name the folder to "**TeslaCam**" (without quotation marks). Click "Save". This folder will contain all recent and saved clips from Sentry Mode and Dashcam.
9. Properly eject the USB flash drive.



Security Settings

For Windows:

1. Insert the USB flash drive into your personal computer.
2. Navigate to **File Explorer**.
3. Right-click on your USB flash drive and select "Format...".
4. In the pop-up menu, under the File System section, select a support format (such as exFAT, FAT 32, etc.)

NOTE: You can also name your USB flash drive (under Volume Label).

5. Check the **Quick format** box and click **Start**.
6. Go back to File Explorer, click on your flash drive, and right-click to create a folder, or select **New Folder** in the top menu.
7. Name the folder "**TeslaCam**" (without quotation marks) and click **Save**. This folder will contain all recent and saved clips from Sentry Mode and Dashcam.
8. Properly eject the USB flash drive.

Once you have formatted the USB flash drive and created the **TeslaCam** folder, insert it into a USB port in Model S. Do not use the rear USB ports—they are for charging only. It may take Model S up to 15 seconds to recognize the flash drive. When recognized, icons for Dashcam and Sentry Mode appear at the top of your touchscreen (note that you may need to enable Sentry Mode by touching **Controls > Safety & Security > Sentry Mode**). Model S is ready to record video.

Save Clips on Honk

Once a properly formatted USB flash drive is inserted in one of the vehicle's front USB ports, you can choose to save Dashcam clips while driving when you honk the horn on your steering wheel. Navigate to **Controls > Safety and Security > Save Clips on Honk > ON** to enable. The most recent ten minutes of footage is saved. You can also save Dashcam footage by touching the Dashcam icon at the top of the touchscreen.



About HomeLink

If your vehicle is equipped with the HomeLink® Universal Transceiver, you can operate up to three Radio Frequency (RF) devices, including garage doors, gates, lights, and security systems.

NOTE: Depending on date of manufacture, market region, and options selected at time of purchase, some vehicles are not equipped with a HomeLink Universal Transceiver.



WARNING: Do not use the HomeLink Universal Transceiver with a device that does not have safety stop and reverse features. Using a device without these safety features increases the risk of injury or death.

Supported Modes

HomeLink supports three different transmit modes, which is how your vehicle and the RF device communicate. Selecting a transmit mode is determined by your RF device's compatibility:

- **Standard Mode:** Use Standard Mode if your RF device is equipped with a remote and the remote must be used to operate the device (for example, a remote-controlled garage door). This is the most common mode used with devices.
- **D-Mode or UR-Mode:** Use D-Mode or UR-Mode if the RF device does not have a remote, and the receiver has a "Learn" button (may also be called "Program" or "Smart"). D-Mode and UR-Mode function similarly because the vehicle directly communicates with the device's receiver, so you don't have to pair a remote.

NOTE: D-Mode is used mainly in North America while UR-Mode is popular in Europe, the Middle East, and Asia. To determine with which mode your device is compatible, contact HomeLink (www.homelink.com or call 1-800-355-3515).

Each of your devices can be set to a different mode. For example, your garage door can be set to Standard Mode, your front gate can be set to D-Mode, etc. To change a transmit mode, touch the HomeLink icon on the touchscreen's status bar and select the device you want to change. Then, select **Program** and choose the desired mode for your device. Confirm by touching **Set Mode** and follow the onscreen instructions.

For older vehicles, changing the mode for one device changes the mode for all devices, so be careful when changing transmit modes. Devices not compatible with your selected mode may not work. Touch the HomeLink icon on the touchscreen's status bar and touch **Change Transmit Mode**.

NOTE: Check the product information for your garage door, gate, light, etc. to determine which mode is compatible with your device.

Programming HomeLink

To program HomeLink® (if equipped):

1. Park Model S so that the front bumper is in front of the garage door, gate, or light you want to program.



CAUTION: Your device might open or close during programming. Before programming, make sure that the device is clear of any people or objects.

2. Get the device's remote control and ensure it has a healthy battery. Tesla recommends replacing the battery in the device's remote control before Programming HomeLink.
3. Touch the HomeLink icon at the top of the touchscreen.
4. Touch **Create HomeLink**, then select which mode you wish to use: Standard, D-Mode, or UR-Mode.
5. Use the touchscreen to enter a name for your device and touch **Enter** or **Create HomeLink**.
6. Touch **Start** then follow the onscreen instructions.

NOTE: If you see a screen called "Train the receiver" while programming the device, remember that this is a time-sensitive step. After pressing the Learn/Program/Smart button on the device's remote, you only have approximately 30 seconds to return to your vehicle, press **Continue**, and then press the trained HomeLink device name twice. Consider having an assistant help with this step.

7. Once your device is programmed, touch **Save** to complete the HomeLink programming routine.
8. Ensure HomeLink works as expected. In some cases the programming process may require multiple attempts before succeeding.

Once programmed, you can operate the device by touching its corresponding HomeLink icon on the touchscreen's status bar. HomeLink remembers the location of your programmed devices. When you approach a known location, the HomeLink control on the touchscreen automatically drops down. When you drive away, it disappears.

NOTE: For additional assistance or compatibility questions, contact HomeLink (www.homelink.com or call 1-800-355-3515).

Auto Opening and Closing

To operate a HomeLink device without touching the touchscreen, you can automate the device to open as you approach, and close as you drive away:

1. Touch the HomeLink icon at the top of the touchscreen and choose the device you want to automate.



HomeLink Universal Transceiver

2. Select the **Auto-open when arriving** checkbox if you want the device to open as you approach.
3. Touch the arrows to specify the distance you want your vehicle to be from the device before it opens.
4. Select the **Auto-close when leaving** checkbox if you want the device to close as you drive away.

As you approach (or drive away from) a device that is set to operate automatically, the HomeLink status icon displays a count-down message to let you know when the device will automatically open or close. In situations where you don't want the device to automatically open or close, touch **Skip Auto-Open** or **Skip Auto-Close** at any time during the count-down message.

Resetting the Location of the HomeLink Device

If you experience situations in which you sometimes drive up to your HomeLink device and it doesn't open, or the HomeLink icon on the touchscreen's status bar does not display the dropdown when you approach the device, you may need to reset the device's location. To do so, park as close as possible to the HomeLink device (garage door, gate, etc.) and display the HomeLink settings page by touching the HomeLink icon at the top of the touchscreen. Touch the name of the device you want to reset, then **Reset Location**.

Deleting a Device

To delete a HomeLink device, touch the HomeLink icon at the top of the touchscreen. Touch the name of the device you want to delete, then touch **Delete**.

NOTE: You can also perform a factory reset to erase your HomeLink settings, along with all other personal data (saved addresses, music favorites, imported contacts, etc.). See [Erasing Personal Data on page 122](#).

NOTE: For security reasons, delete your HomeLink devices if you sell your Model S.

Troubleshooting HomeLink

Standard Mode

In Standard Mode, Model S records the signal from the remote of your RF device. The touchscreen instructs you to stand in front of the vehicle, point the remote at the front bumper, and press and hold the button until the headlights flash. When the headlights flash, Model S has learned the remote and you can touch **Continue** on the touchscreen. If the headlights do not flash, refer to the following guidelines:

- Check the batteries in the remote. It is a good idea to replace the batteries before you start programming.

- While standing in front of your vehicle, press and hold the button on your device's remote, with the remote approximately 5 cm in front of the Tesla emblem. In some cases you must hold the button on the remote for up to three minutes.
- Certain garage door remotes may require multiple short remote presses (approximately 1 second each press) instead of one long duration press.

D-Mode and UR-Mode

In D Mode and UR-Mode, the device's receiver learns Model S. The touchscreen instructs you to press the "Learn" button (may also be called "Program" or "Smart") on the device's receiver. If this does not work, refer to the following guidelines:

- Park Model S with its bumper as close as possible to the garage door, gate, etc. that you are trying to program.
- Make sure you are pressing the receiver's Learn/Program/Smart button. For instructions on how to put the receiver into learning mode, refer to the product details provided with your RF device that you are trying to program.
- If you see a screen called "Train the receiver" while programming the device, remember that this is a time-sensitive step. After pressing the Learn/Program/Smart button on the device's remote or receiver, you only have approximately 30 seconds to return to your vehicle, press **Continue**, then press the trained HomeLink device name twice. Consider having someone assist you with this step.
- Most devices stay in learning mode for only three to five minutes. Immediately after pressing the device's Learn/Program/Smart button, follow the instructions displayed on the vehicle's touchscreen.

For additional assistance or compatibility questions, contact HomeLink (www.homelink.com or call 1-800-355-3515).



Wi-Fi is available as a data connection method and is often faster than cellular data networks. Connecting to Wi-Fi is especially useful in areas with limited or no cellular connectivity. To ensure fast, reliable delivery of software and map updates, Tesla recommends leaving your vehicle connected to a Wi-Fi network whenever possible (for example, if parked in your garage overnight).

To connect to a Wi-Fi network:

1. Touch the cellular icon (usually **LTE** or **3G**) on the top corner of your touchscreen. Model S will start scanning and display the detected Wi-Fi networks that are within range.
2. Select the Wi-Fi network you want to use, enter the password (if necessary), then touch **Confirm**.
3. Your vehicle connects to the Wi-Fi network and will automatically connect to it whenever the network is within range.

You can also connect to a hidden network that isn't shown on the list of scanned networks. Just touch **Wi-Fi Settings**, enter the name of the network in the resulting dialog box, select the security setting, then touch **Add Network**.

NOTE: If more than one previously connected network is within range, Model S connects to the one most recently used.

NOTE: You can also use a mobile hotspot or your phone's Internet connection via Wi-Fi tethering (subject to fees and restrictions of your mobile carrier).

NOTE: At Tesla Service Centers, Model S automatically connects to the Tesla Service Wi-Fi network.

Loading New Software

Tesla updates your vehicle's software wirelessly, constantly providing new features. Tesla recommends you install software updates as soon as they are available on your vehicle. To ensure the fastest and most reliable delivery of software updates, leave Wi-Fi turned on and connected whenever possible. In most cases, your vehicle must be connected to Wi-Fi to start an update (see [Connecting to Wi-Fi on page 147](#)).

NOTE: On an as-needed basis, Tesla also sends software updates using a cellular connection.

NOTE: Software updates are not performed when Smart Preconditioning, Keep Climate On, Dog Mode, or Camp Mode is active.

 **WARNING:** Do not attempt to use the vehicle while the software is being updated. Vehicle functions, including some safety systems, may be limited or disabled when a software update is in progress and you could damage the vehicle.

When a software update is available, a yellow clock icon appears at the top of the touchscreen. There are three ways you can install software updates:

- Touch the yellow clock icon to display the scheduling window, which prompts you to select a time to install the update (**SET FOR THIS TIME**) or install it now (**INSTALL NOW**). Once scheduled, the yellow clock icon changes to a white clock icon until the update begins. At any time before the update begins, you can touch this clock icon to reschedule the update.
- Go to **Controls > Software** to determine if an update is available for your vehicle. If available, touch **Software Update Available** to navigate to the scheduling window, as mentioned above.
- Start updates using the Tesla mobile app.

NOTE: Some software updates can take up to three hours to complete. Model S must be in Park while the software is being updated. To ensure the fastest and most reliable delivery of software updates, leave the Wi-Fi turned on and connected whenever possible (see [Connecting to Wi-Fi on page 147](#)).

The yellow clock icon becomes a green download icon when a software update is downloading. If a yellow download icon displays, a software update is available but your vehicle is not connected to Wi-Fi. Connect your vehicle to Wi-Fi to start the download.

Software Update Preferences

You can choose how quickly and often you receive software updates. To change your preference, navigate to **Controls > Software > Software Update Preferences** and choose either of these options:

- **STANDARD:** Receive software updates using the normal rollout timeframe for your region and vehicle configuration. When a software release is made available it has generally been running on other customer vehicles for a period of time.
- **ADVANCED:** Receive the latest software updates for your region and vehicle configuration as soon as they are available. Tesla determines how, when, and where to send updates to vehicles based on various factors unique to each release. Keep in mind that although you receive updates as soon as they are available for your specific vehicle, you may not be in the first Tesla group of Tesla owners to receive the update. Choosing Advanced does not enroll your vehicle in Tesla's early access program.

NOTE: Tesla does not update software upon request for those wanting to receive the latest features and improvements. Selecting **ADVANCED** and consistently connecting to Wi-Fi (see [Connecting to Wi-Fi on page 147](#)) is the best way to receive the latest software updates.

NOTE: The software update window persists until you install the update. You must install a software update as soon it becomes available. Any harm resulting from failure to install a software update is not covered by the vehicle's warranty. Failure or refusal to install updates can cause some vehicle features to become inaccessible, digital media devices to become incompatible, and can limit Tesla's ability to diagnose and service your vehicle.

NOTE: Reverting to a previous software version is not possible.

If the touchscreen displays a message indicating that a software update was not successfully completed, contact Tesla.

Software Reinstall

In some situations, such as when a component in your vehicle has been replaced, it may be necessary to reinstall the existing version of software. To do so, touch **Controls > Service > Software Reinstall**. Installation takes approximately 25 minutes to complete. Existing settings are not affected and no new software files are downloaded to Model S.

Charging

If Model S is charging when the software update begins, charging stops. Charging resumes automatically when the software update is complete. If you are driving Model S at the scheduled update time, the update is canceled and must be rescheduled.



Viewing Release Notes

When a software update is complete, read the release notes displayed on the touchscreen to learn about changes or new features. To display release notes about the current version of your vehicle's software at any time, touch the Tesla "T" at the top center of the touchscreen, then touch **Release Notes**. You can also view the release notes by touching **Controls > Software**.

Tesla strongly recommends reading all release notes. They may contain important safety information or operating instructions for your Model S.

The Tesla mobile app allows you to communicate with Model S remotely using your iPhone® or Android™ phone.

To use the mobile app

To set up the Tesla mobile app to communicate with your Model S:

1. Download the Tesla mobile app to your phone.
2. Log in to the Tesla mobile app by entering your Tesla account credentials.
3. Enable mobile access to your Model S by touching **Controls > Safety & Security > Mobile Access** (see [Controls on page 117](#)).

Your smartphone and vehicle must both be actively connected to cellular service to allow the mobile app to communicate with your vehicle. Tesla recommends that you always have a functional physical key readily available if parking in an area with limited or absent cellular service, such as an indoor parking garage.

If multiple vehicles are linked to the Tesla Account, you must switch to the Model S you want to access in the mobile app before the phone can be used as a key. Swipe left or right to change vehicles.

NOTE: In the event that you require lockout assistance from Tesla due to a non-warranty issue, such as having limited cellular connectivity and having no secondary key available, your expenses are not covered under the Roadside Assistance policy.

NOTE: Tesla does not support the use of third party applications to contact Model S.

Overview

The Tesla mobile app's home screen allows you to:

- See the name of your vehicle (if you have one)
- View your vehicle's estimated range.
- See which gear the vehicle is in (driving, park, etc.).
- Enable maximum defrost to warm your vehicle in cold conditions.
- Enable keyless driving.
- Open the front trunk.
- Lock or unlock your vehicle.
- At the bottom, view your vehicle's odometer, VIN, and firmware version it is currently running.

For supported video sources, send videos to play in the Tesla Theater by sharing the link through the mobile app. Navigate to the movie, show, or video you want to play on your smartphone and touch the share button. Share the video with the Tesla app and it will appear on your vehicle's touchscreen if Model S is in Park.

Climate

Check the interior temperature and heat or cool the cabin before driving (even if it's in a garage). You can also turn the seat heaters on (see [Seat Heaters on page 24](#)) and defrost the windshield by touching the windshield defrost icon at the bottom.

Turn Climate On: This allows you to precondition the cabin to your desired temperature and turn on or off the steering wheel and seat heaters.

Defrost helps to melt snow, ice, and frost on the windshield, driver and passenger windows, mirrors.

Using the mobile app to precondition Model S also warms the Battery as needed.

NOTE: In extremely cold weather or icy conditions, it is possible that your charge port latch may freeze in place. In cases where you cannot remove or insert the charge cable, or the vehicle is not Supercharging due to the latch being frozen in place, use your Tesla mobile app to precondition your vehicle on **HI** for approximately 30-45 minutes (you must use your mobile app to precondition the vehicle; setting your climate to **HI** using the touchscreen will not be effective). This can help thaw ice on the charge port latch so the charge cable can be removed or inserted.

Controls

The Controls tab allows you do the following:

- Vent the windows.
- Vent or close the sunroof.
- Lock or unlock Model S from afar.
- Flash the lights or honk the horn to find where Model S is parked.
- Enable Keyless Driving.

NOTE: Keyless Driving can be used when you do not have your key or to bypass PIN to Drive in cases where you forgot your PIN or your touchscreen is unresponsive (see [PIN to Drive on page 141](#)).

- Open the front or rear trunk.
- Open and close your garage door if your vehicle has a programmed HomeLink connection, if available (see [HomeLink Universal Transceiver on page 145](#)).
- Enable or disable valet mode (see [Valet Mode on page 38](#)).
- Enable/disable Sentry Mode (see [Sentry Mode on page 141](#)).
- Enable/disable Speed Limit Mode and receive notifications when the vehicle's driving speed is within approximately 5 km/h of your selected maximum speed (see [Speed Limit Mode on page 122](#)).

Charging

Check charging progress, stop charging, and receive notifications when charging is started, interrupted, almost complete, or complete. You can also view nearby chargers and send the directions to your vehicle's touchscreen.

NOTE: When Supercharging, additional notifications alert you when you will be charged idle fees for parking at a supercharger after charging is complete. The idle fees are waived if your vehicle is moved within five minutes of when the vehicle finishes charging. See [Supercharger Usage Fees and Idle Fees on page 159](#).

Location

Locate Model S with directions, or track its movement across a map.

Summon

You can park or retrieve Model S using Summon (see [Summon on page 103](#)) or Smart Summon (see [Smart Summon on page 106](#)), if equipped.

Upgrades

View and purchase the latest upgrades available for your vehicle, such as full self-driving.

Schedule Service

Scheduling a service visit through the mobile app is easy. After touching **Schedule Service**, select the type of service needed and follow the directions in the mobile app. Provide as much detail as possible, such as:

- Photos, sound recordings, or videos.
- Date(s), time(s), and time zone when the issue occurred.
- Country of use and location.
- Approximate speed the vehicle was traveling (if applicable).
- Environmental conditions (rain, snow, cold, etc.).
- Road name and type of road (if applicable).
- Quality of lane markings (if applicable).
- Applicable vehicle settings.
- Identifiable symptoms.

Settings

In this settings tab located at the top corner of your smartphone's screen (shown as a gear icon), you can:

- Switch to a different vehicle associated with your Tesla account, if you have access to more than one.
- Access the Tesla inbox.
- View Notifications and customize the notifications you receive, such as when your security alarm has been triggered, charging updates, and new software updates. You can start them from afar and check its progress.
- Enable or disable Touch ID.
- Support the Model S Calendar app on the touchscreen by allowing the mobile app to send your phone's calendar data to your vehicle.

NOTE: Some of these features require installation of the latest version of the mobile app.

NOTE: The above list may not represent an exhaustive list of the functions available on the Tesla mobile app. To ensure access to new and improved features, download updated versions of the mobile app as they become available.

Granting Mobile App Access to a Second User

It's easy to grant mobile app access to a second user of your vehicle (such as a family member or friend). Log into your Tesla account and navigate to **Account > Personal Information > Contact > Add Additional Contact**. Add the secondary user's contact information. If the secondary user already has a Tesla account, use the email address associated with their existing Tesla account. They can then access your Model S from the mobile app. If they do not have a Tesla account, a welcome email will be sent to their registered email address. Once the account is created, they can access your vehicle from the mobile app. With mobile app access, secondary users can view and control your vehicle's settings remotely.

To remove access, delete the contact information of the second user.

NOTE: Granting mobile app access to a secondary user allows them to view and control everything your mobile app can control.

NOTE: Tesla currently does not support the addition of third or fourth users.



Electric Vehicle Components

High Voltage Components

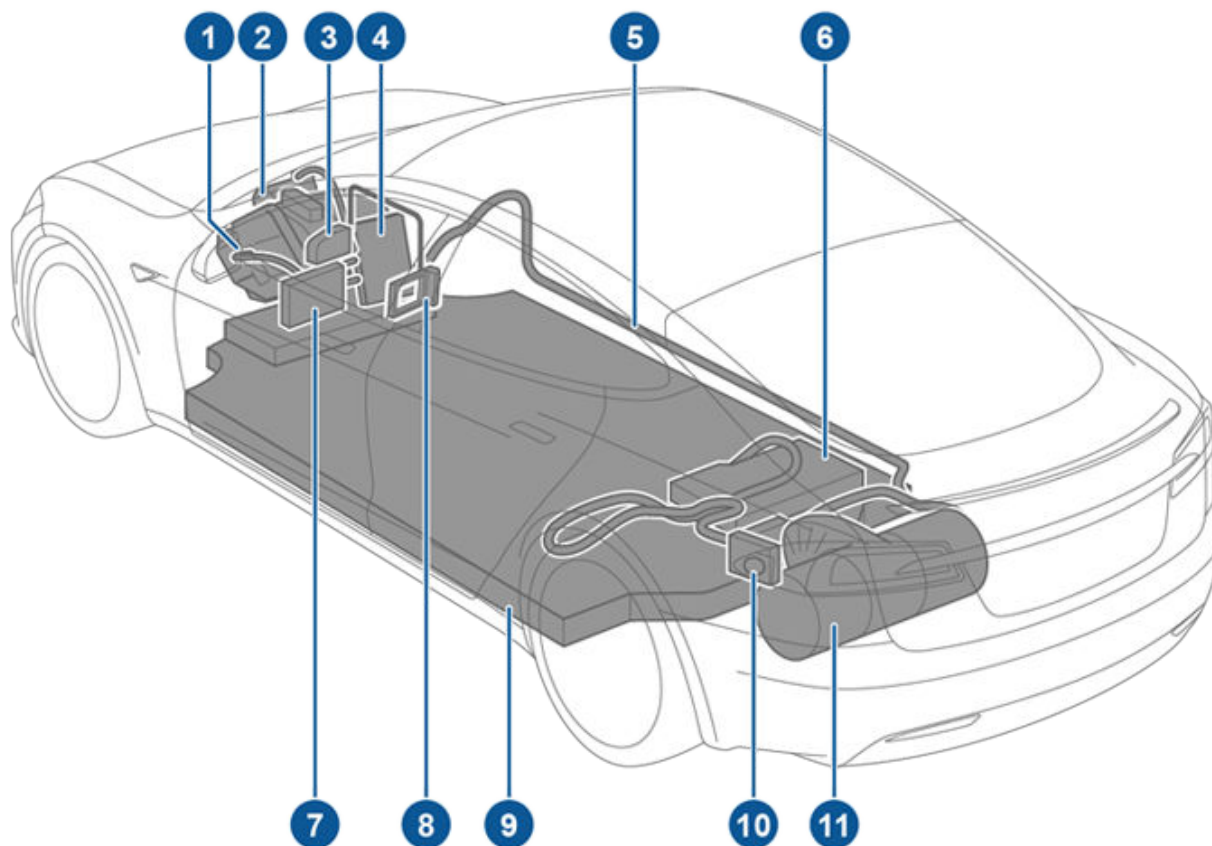

1. Front Motor (All-Wheel Drive vehicles only)
2. Air Conditioning Compressor
3. Battery Coolant Heater
4. Forward Junction Box
5. High Voltage Cabling
6. On-board Charger
7. DC-DC Converter
8. Cabin Heater
9. High Voltage Battery
10. Charge Port
11. Rear Motor

⚠ WARNING: The high voltage system has no user serviceable parts. Do not disassemble, remove or replace high voltage components, cables or connectors. High voltage cables are typically colored orange for easy identification.

⚠ WARNING: Read and follow all instructions provided on the labels that are attached to Model S. These labels are there for your safety.

⚠ WARNING: In the unlikely event that a fire occurs, immediately contact your local fire emergency responders.



Charging Equipment

Charging equipment designed specifically to charge your Model S is available from Tesla. A Tesla Wall Connector, which installs in your garage, is the fastest way to charge Model S at home.

In most market regions, Model S is equipped with a Mobile Connector and the adapter(s) needed to plug into the most commonly used power outlets. When using the Mobile Connector, first plug the Mobile Connector into the power outlet, and then plug in Model S. For more information about your Mobile Connector, see the Mobile Connector Owner's Manual (available on the touchscreen). Additional adapters can be purchased from Tesla.

Tesla offers adapters (for example, J1772, CHAdeMO, and Combined Charging System (CCS)) to allow you to plug into the most commonly used public charging stations in your region. Open the charge port door using the touchscreen (see [Charging Instructions on page 155](#)), plug the adapter into the charging port on Model S, and then connect the station's charging connector to the adapter. For information on the charging equipment available for your region, go to www.tesla.com/en_AU, and then view the available charging options.

More details on public charging station adapters is available at <https://www.tesla.com/chademo>.

About the Battery

Model S has one of the most sophisticated battery systems in the world. The most important way to preserve the Battery is to **LEAVE YOUR VEHICLE PLUGGED IN** when you are not using it. This is particularly important if you are not planning to drive Model S for several weeks. When plugged in, Model S wakes up when needed to automatically maintain a charge level that maximizes the lifetime of the Battery.

NOTE: When left idle and unplugged, your vehicle periodically uses energy from the Battery for system tests and recharging the 12V battery when necessary.

There is no advantage to waiting until the Battery's level is low before charging. In fact, the Battery performs best when charged regularly.

NOTE: If you allow the Battery to discharge to 0%, other components may become damaged or require replacement (for example, the 12V battery). In these cases, you are responsible for repair and/or transporting expenses. Discharge-related expenses are not covered by the warranty or under the Roadside Assistance policy.

The peak charging rate of the Battery may decrease slightly after a large number of DC Fast Charging sessions, such as those at Superchargers. To ensure maximum driving range and Battery safety, the Battery charge rate is decreased when the Battery is too cold, when the Battery's charge is nearly full, and when the Battery conditions change with usage and age. These changes in the condition of the Battery are driven by battery physics and may increase the total Supercharging duration by a few minutes over time.

Battery Care

Never allow the Battery to fully discharge. Even when Model S is not being driven, its Battery discharges very slowly to power the onboard electronics. The Battery can discharge at a rate of approximately 1% per day, though the discharge rate may vary depending on environmental factors (such as cold weather), vehicle configuration, and your selected settings on the touchscreen. Situations can arise in which you must leave Model S unplugged for an extended period of time (for example, at an airport when traveling). In these situations, keep the 1% in mind to ensure that you leave the Battery with a sufficient charge level. For example, over a two week period (14 days), the Battery may discharge by approximately 14%.

Discharging the Battery to 0% may result in damage to vehicle components. To protect against a complete discharge, Model S enters a low-power consumption mode when the displayed charge level drops to approximately 0%. In this mode, the Battery stops supporting the onboard electronics and auxiliary 12V

battery. Once this low-power consumption mode is active, immediately plug in Model S to prevent a jump-start and 12V battery replacement.

NOTE: If the vehicle is unresponsive and will not unlock, open, or charge, then the 12V battery may have become discharged. In this situation, contact Tesla.

Temperature Limits

For better long-term performance, avoid exposing Model S to ambient temperatures above 60° C or below -30° C for more than 24 hours at a time.

Energy Saving Feature

Model S has an energy-saving feature that reduces the amount of energy being consumed by the displays when Model S is not in use. On newer vehicles, this feature is automated to provide an optimal level of energy saving. However, on older vehicles, you can control the amount of energy being consumed by the displays by touching **Controls > Display > Energy Saving**. For more information on maximizing range and saving energy, see [Getting Maximum Range on page 71](#).

Battery Warnings and Cautions



WARNING: The Battery has no parts that an owner or a non-Tesla authorized service technician can service. Under no circumstances should you open or tamper with the Battery. Always contact Tesla to arrange for Battery servicing.



CAUTION: If the Battery's charge level falls to 0%, you must plug it in. If you leave it unplugged for an extended period, it may not be possible to charge or use Model S without jump starting or replacing the 12V battery. Leaving Model S unplugged for an extended period can also result in permanent Battery damage. If you are unable to charge Model S, contact Tesla immediately.



CAUTION: The Battery requires no owner maintenance. Do not remove the coolant filler cap and do not add fluid. If the instrument panel warns you that the fluid level is low, contact Tesla immediately.



CAUTION: Do not use the Battery as a stationary power source. Doing so voids the warranty.



Opening the Charge Port

The charge port is located on the left side of Model S, behind a door that is part of the rear tail light assembly. Before charging, park Model S to ensure that the charge cable easily reaches the charge port.

With Model S unlocked (or a recognized key is within range) and in Park, press and release the button on the Tesla charge cable to open the charge port door.

NOTE: If the charge cable is in range of the charge port door, you can press the button on the charge cable to open the charge port door even when Model S is locked or a recognized key is not in range.



You can also open the charge port door using any of these methods:

- On the touchscreen, use the app launcher to open the Charging app, then touch **Open Charge Port**.
- On the Model S touchscreen, touch **Controls** > **Quick Controls** then touch the charging icon.
- Press the charge port door when Model S is unlocked or a recognized key is nearby.
- On the key, hold down the rear trunk button for 1-2 seconds.

NOTE: The following image is provided for demonstration purposes only. Depending on market region, your charge port may be slightly different.



NOTE: The charge port lights up white when you open the charge port door. If you do not insert a charge cable into the charge port within a few minutes after opening the charge port door, the charge port door closes. If this happens, use the touchscreen to open the charge port door again.

NOTE: In extremely cold weather or icy conditions, it is possible that your charge port latch may freeze in place. In cases where you cannot remove or insert the charge cable, or the vehicle is not Supercharging due to the latch being frozen in place, use your Tesla mobile app to precondition your vehicle on **HI** for approximately 30-45 minutes (you must use your mobile app to precondition the vehicle; setting your climate to **HI** using the touchscreen will not be effective). This can help thaw ice on the charge port latch so the charge cable can be removed or inserted.



CAUTION: Do not try to force the charge port door open.

Plugging In

If desired, use the touchscreen to change the charge limit and the charging current (see [Changing Charge Settings on page 157](#)).

To charge at a public charging station, plug the appropriate adapter into the vehicle's charging port, and then connect the station's charging connector to the adapter. The most commonly used adapter(s) for each market region are provided. Depending on the charging equipment you are using, you may need to start and stop charging using a control on the charging equipment.

If you are using the Mobile Connector, plug it into the power outlet before plugging it into Model S.



Charging Instructions

Align the connector to the charge port and insert fully. When the connector is properly inserted, charging begins automatically after Model S:

- Engages a latch that holds the connector in place;
- Shifts into Park (if it was in any other gear);
- Heats or cools the Battery, if needed. If the Battery requires heating or cooling, you may notice a delay before charging begins.

NOTE: Whenever Model S is plugged in but not actively charging, it draws energy from the wall outlet instead of using energy stored in the Battery. For example, if you are sitting in Model S and using the touchscreen while parked and plugged in, Model S draws energy from the wall outlet instead of the Battery.

 **CAUTION:** The connector end of the charge cable can damage the paint if dropped onto the vehicle.

During Charging

During charging, the charge port light pulses green, and the instrument panel displays the charging status. The frequency at which the charge port light pulses slows down as the charge level approaches full. When charging is complete, the light stops pulsing and is solid green.

NOTE: If Model S is locked, the charge port light does not light up.

If the charge port light turns red while charging, a fault is detected. Check the instrument panel or touchscreen for a message describing the fault. A fault can occur due to something as common as a power outage. If a power outage occurs, charging resumes automatically when power is restored.

NOTE: When charging, particularly at high currents, the refrigerant compressor and fan operate as needed to keep the Battery cool. Therefore, it is normal to hear sounds during charging.

NOTE: Air conditioning performance is generally not affected by charging. However, under certain circumstances (for example, you are charging at high currents during a particularly warm day), the air coming from the vents may not be as cool as expected and a message displays on the instrument panel. This is normal behavior and ensures that the Battery stays within an optimum temperature range while charging to support longevity and optimum performance.

 **WARNING:** Never spray liquid at a high velocity (for example, if using a pressure washer) towards the charge port while charging. Failure to follow these instructions can result in serious injury or damage to the vehicle, charging equipment, or property.

Stopping Charging

Stop charging at any time by disconnecting the charge cable or touching **Stop Charging** on the touchscreen.

NOTE: To prevent unauthorized unplugging of the charge cable, the charge cable latch remains locked and Model S must be unlocked or able to recognize your key before you can disconnect the charge cable.

To disconnect the charge cable using a connector:

1. Press and hold the button on the connector handle to release the latch. Alternatively, unlock the vehicle by opening a door, using a key fob, or touching **Stop Charging** on the touchscreen. These methods unlock the charge port as well.
2. Pull the connector from the charge port.
3. Push the charge port door closed.

To disconnect the charge cable using an adapter at a public charge station:

1. Ensure that Model S is unlocked.
2. While holding the public charging handle in one hand and the adapter in the other hand, press and hold the button on the public charging handle and pull both outwards, removing the handle and adapter at the same time.

NOTE: If the charging station handle separates from the adapter, leaving the adapter in Model S, use the touchscreen to unlock the charge port (touch the charging icon on the overhead view of the vehicle).

3. Press and hold the charging handle button again to release the adapter from the charging handle.

NOTE: If Model S is equipped with a motorized charge port door, it automatically closes shortly after you remove the charge cable.

 **CAUTION:** Tesla strongly recommends leaving Model S plugged in when not in use. This maintains the Battery at the optimum level of charge.

Manually Releasing Charge Cable

If the usual methods for releasing a charge cable from the charge port (using the charge handle release button, touchscreen, or mobile app) do not work, carefully follow these steps:

1. Ensure that Model S is not actively charging by displaying the charging screen on the touchscreen. If necessary, touch **Stop Charging**.
2. Open the rear trunk.
3. Open the flap on the left side of the trunk side trim.



- Press and hold the charge port's manual release lever towards the front of the vehicle to unlatch the charge cable.

WARNING: Do not touch or attempt to remove the orange High Voltage cover. Failure to follow these instructions can result in electric shock and serious injury.

NOTE: If your vehicle does not have a charge port manual release lever, discontinue this procedure and contact your closest Service Center.

NOTE: The orientation of the manual release lever may vary depending on market region.



- Pull the charge cable from the charge port.
- Close the flap on the left side of the trunk side trim.

CAUTION: The release lever is designed for use only in situations where the charge cable cannot be released from the charge port using the usual methods. Continuous use may result in damage to the release lever or charging equipment.

WARNING: Do not perform this procedure while your vehicle is charging or if any orange high voltage conductors are exposed. Failure to follow these instructions can result in electric shock and serious injury or damage to the vehicle. If you have any uncertainty as to how to safely perform this procedure, contact your closest Service Center.

WARNING: Do not attempt to remove the charge cable at the same exact time as you begin to press the release lever towards the front of the vehicle. Always press the release lever towards the front of the vehicle and hold it before you begin to remove the charge cable from the charge port. Failure to follow these instructions can result in electric shock and serious injury.

Charge Port Light

- WHITE:** The charge port door is open. Model S is ready to charge and the connector is not inserted, or the charge port latch is unlocked and the connector is ready to be removed.
- BLUE:** Model S detects that a connector has been plugged in.
- BLINKING BLUE:** Model S is communicating with the connector. Either Model S is preparing to charge, or a charging session is scheduled to begin at a specified future time.
- BLINKING GREEN:** Charging is in progress. As Model S approaches a full charge, the frequency of the blinking slows.
- SOLID GREEN:** Charging is complete.
- SOLID AMBER:** The connector is not fully plugged in. Realign the connector to the charge port and insert fully.
- BLINKING AMBER:** Model S is charging at a reduced current (AC charging only).
- RED:** A fault is detected and charging has stopped. Check the instrument panel or touchscreen for a fault message.

Changing Charge Settings

The charging screen displays on the touchscreen whenever the charge port door is open. To display the charging screen at any time:



Charging Instructions



Touch the Apps icon, then touch the charging icon.

NOTE: The following illustration is provided for demonstration purposes only and may vary slightly depending on software version and market region.

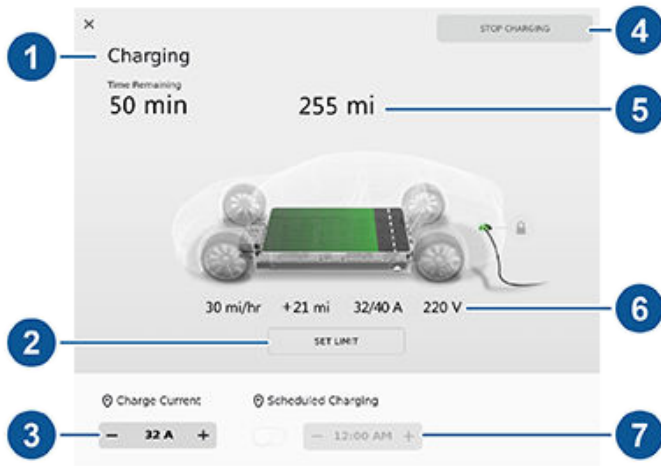

NOTE: If charging at a Tesla Supercharger, and paid supercharging is potentially in effect, the charging screen also displays information about your previous or current Supercharger session (see [Supercharger Usage Fees and Idle Fees on page 159](#)).

NOTE: To reduce congestion at high-usage supercharger sites, you may be automatically limited to a maximum charge of 80% when not using Trip Planner (see [Trip Information on page 70](#)). You can manually increase the limit by tapping “Set Limit” on the touchscreen or mobile app.

1. Charge status messages (such as Charging Scheduled, Charging) display here.
2. To adjust the charge limit, touch **Set Limit**, and drag the arrow to change the charge limit setting. The setting you choose applies to immediate and scheduled charging sessions.
3. The current automatically sets to the maximum current available from the attached charge cable, unless it was previously reduced to a lower level. If needed, touch - or + to change the current (for example, you may want to reduce the current if you are concerned about overloading a domestic wiring circuit shared by other equipment). It is not possible to set the charging current to a level that exceeds the maximum available from the attached charge cable. When you change the current, Model S remembers the location. If you charge at the same location, you do not need to change it again.

NOTE: For 3-phase charging (if applicable in your region), the available current represents the current per phase (up to 32 amps). During charging, the right status flag displays the 3-phase symbol in front of the displayed current.

NOTE: If Model S automatically reduced the current at a charging location because of fluctuations in input power (see the note in [Charging Status on page 159](#)), Tesla recommends charging at the lower current until the underlying problem is resolved and the charging location can provide consistent power.

4. Touch to open the charge port door or to start (or stop) charging.
5. Energy level.
6. Charging rate, estimated increase in driving distance (or energy) achieved so far in this charging session, duration of charging session so far, current supplied/available from the connected power supply, and voltage supplied by the charge cable.
7. Location-specific schedule. With Model S in Park, set a specific time to begin charging at the current location (see [Scheduled Charging and Scheduled Departure on page 158](#)).

Scheduled Charging and Scheduled Departure

There are two ways in which you can schedule your vehicle’s charging:

- **Scheduled Charging:** When you set a scheduled charging time, Model S displays the set time to begin charging when you are parked at the scheduled location. If, at the scheduled time, Model S is not plugged in at the location, charging starts as soon as you plug it in, provided you plug it in within six hours of the scheduled time. If plugged in after six hours, charging does not start until the scheduled time on the next day. To override this setting, touch **Start Charging** or **Stop Charging**. When you set a scheduled charging time, Model S displays the set time on the instrument panel and touchscreen.
- **Scheduled Departure:** For any location, such as Home, you can simply plug in Model S and select a time for when you want your vehicle to be ready to drive. Once your specified time is set, Model S prepares itself by determining the best time to start charging to optimize energy costs, Battery longevity, and ensure charging completes in time for your drive. Your vehicle also preconditions the cabin to a comfortable temperature and warms the Battery. To set up a scheduled departure time, go to **Charging > Scheduled Departure > Schedule** and follow the onscreen instructions to customize your schedule.

Scheduled Charging is best used to determine when your vehicle should start charging; Scheduled Departure is best used to determine when charging should complete for your drive.



NOTE: Your vehicle aims to finish charging before 6am (end of off-peak hours). If given sufficient time to charge, charging may stop at 6am, even if your scheduled departure is later. The vehicle warms the Battery and preconditions the cabin shortly before your scheduled departure time. If the vehicle does not have enough time to complete charging before 6am, it will continue to charge until it reaches the target Battery percentage.

NOTE: If your vehicle is not plugged into a charger, Scheduled departure will not precondition the cabin or battery.

Charging Status

The following illustration is provided for demonstration purposes only and may vary slightly depending on the software version and market region.

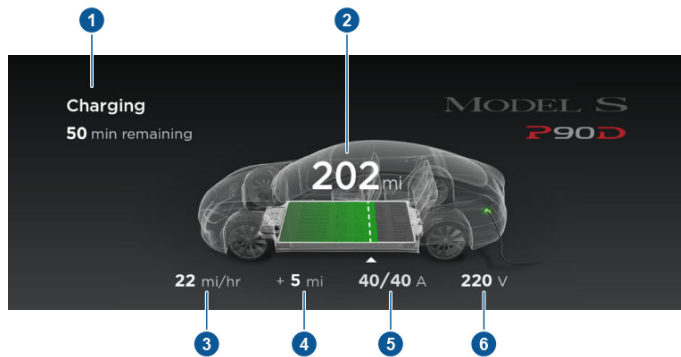

1. Charging status information. For example, when Model S is charging, it displays the time remaining until fully charged at the currently selected charge level. When a charging session is scheduled, it displays when charging starts.
2. Total estimated driving distance (or energy) available. To choose between displaying distance or energy percentage, touch **Controls > Display > Energy Display**.

NOTE: A portion of the battery image may appear blue. This indicates that a small portion of the energy stored in the battery is not available because the battery is cold. This is normal and no reason for concern. When the battery warms up, the blue portion no longer displays.

3. Charging rate per hour.
4. Estimated increase in driving distance (or energy) achieved so far in this charging session.
5. Current supplied/available from the connected power supply (see [Changing Charge Settings on page 157](#)).

3 If connected to a 3-phase power supply (if applicable in your region), the available current represents the current per phase and the 3-phase symbol displays.

6. Voltage supplied by the charge cable.

NOTE: If Model S is charging and detects unexpected fluctuations in input power, the charging current is automatically reduced by 25%. For example, a 40 amp current is reduced to 30 amps. This automatic current reduction increases robustness and safety in situations when an external problem exists (for example, a home wiring system, receptacle, adapter or cord is unable to meet its rated current capacity). As a precaution, when Model S automatically reduces current, it saves the reduced current at the charging location. Although you can manually increase it, Tesla recommends charging at the lower current until the underlying problem is resolved and the charging location can provide consistent power.

Supercharger Usage Fees and Idle Fees

When charging using a Tesla supercharger, **SUPERCHARGING** information displays at the bottom of the charging screen. This information includes the location, the time that charging started, and an estimate of how much the session will cost. When you stop supercharging, the estimated cost of that session displays until a new supercharging session begins. If free charging is applicable, the estimated cost displays as zero.

NOTE: Estimated pricing is displayed for your convenience only and may not reflect the actual final price you will be charged for that supercharging session. Final pricing for supercharging sessions can be found in your Tesla Account.

When charging at a Tesla supercharger, you are subject to idle fees. Idle fees are designed to encourage drivers to move their vehicle from the Supercharger when charging is complete. Idle fees are in effect only when half or more of the Superchargers at a site are occupied. The Tesla mobile app notifies you when charging nears completion, and again when charging is complete. Additional notifications are sent if idle fees are incurred. Idle fees are waived if you move your vehicle within five minutes of charging completion.

Log into your Tesla Account to view fees and details about Supercharger sessions, track the remaining balance of free credits, set up a payment method, and make payments. Once a payment method is saved, fees are automatically paid from your account.



Service Intervals

Your vehicle should generally be serviced on an as-needed basis. However, Tesla recommends the following maintenance items and intervals, as applicable to your vehicle, to ensure continued reliability and efficiency of your Model S.

- Brake fluid health check every 2 years (replace if necessary).
- A/C desiccant bag replacement every 2 years
- Cabin air filter replacement every 2 years
- HEPA filter replacement every 3 years
- Clean and lubricate brake calipers every year or 12,500 miles (20,000 km) if in an area where roads are salted during winter
- Rotate tires every 10,000 km or if tread depth difference is 1.5 mm or greater, whichever comes first

NOTE: The above intervals are based on normal driving behaviors and scenarios. Additionally, the above list should not be considered comprehensive and does not include consumable parts such as windshield wipers, brake pads, etc.

NOTE: Damages or failures caused by maintenance or repairs performed by non-Tesla certified technicians are not covered by the warranty.

Daily Checks

- Check the Battery's charge level, displayed on the instrument panel or mobile app.
- Check the condition and pressure of each tire (see [Tire Care and Maintenance on page 162](#)).
- Check that all exterior lights, horn, turn signals, and wipers and washers are working.
- Check for any unexpected indicator lights or vehicle alerts on the touchscreen or instrument panel.
- Check the operation of the brakes, including the parking brake.
- Check the operation of the seat belts (see [Seat Belts on page 25](#)).
- Look for abnormal fluid deposits underneath Model S that might indicate a leak. It is normal for a small pool of water to form (caused by the air conditioning system's dehumidifying process).
- Look around the exterior of Model S and immediately remove any corrosive substances (such as bird droppings, tree resin, tar spots, dead insects, industrial fallout, etc.) to prevent damage to the paint (see [Cleaning on page 167](#)).

Monthly Checks

- Check windshield washer fluid level and top up if necessary (see [Topping Up Windshield Washer Fluid on page 172](#)).
- Check that the air conditioning system is operating correctly (see [Climate Controls on page 123](#)).

NOTE: In addition to cooling the interior, the air conditioning compressor also cools the Battery. Therefore, in hot weather, the air conditioning compressor can turn on even if you turned it off. This is normal because the system's priority is to cool the Battery to ensure it stays within an optimum temperature range to support longevity and optimum performance. Also, even when not in use, you may hear Model S emit a whining noise or the sound of water circulating. These sounds are normal and occur when the internal cooling systems turn on to support various vehicle functions, such as maintaining the 12V battery and balancing the temperature of the high voltage Battery.



WARNING: Contact Tesla immediately if you notice any significant or sudden drop in fluid levels or uneven tire wear.

Fluid Replacement Intervals

Your Battery coolant does not need to be replaced for the life of your vehicle under most circumstances. Brake fluid should be checked every 2 years, replacing if necessary.



NOTE: Any damage caused by opening the Battery coolant reservoir is excluded from the warranty.

High Voltage Safety

Your Model S has been designed and built with safety as a priority. However, be aware of these precautions to protect yourself from the risk of injury inherent in all high-voltage systems:

- Read and follow all instructions provided on the labels that are attached to Model S. These labels are there for your safety.
- The high voltage system has no user-serviceable parts. Do not disassemble, remove or replace high voltage components, cables or connectors. High voltage cables are colored orange for easy identification.
- If a collision occurs, do not touch any high voltage wiring, connectors, or components connected to the wiring.
- In the unlikely event that a fire occurs, immediately contact your local fire emergency responders.



-  **WARNING:** Always disconnect the charge cable before working underneath Model S, even if charging is not in progress.
-  **WARNING:** Keep your hands and clothing away from cooling fans. Some fans operate even when Model S is powered off.
-  **WARNING:** Some fluids (battery acid, Battery coolant, brake fluid, windshield washer additives, etc.) used in vehicles are poisonous and should not be inhaled, swallowed, or brought into contact with open wounds. For your safety, always read and follow instructions printed on fluid containers.



Tire Care and Maintenance

Maintaining Tire Pressures

Keep tires inflated to the pressures shown on the Tire and Loading Information label, even if it differs from the pressure printed on the tire itself. The Tire and Loading Information label is located on the center door pillar and is visible when the front door is open.



The Tire Pressure indicator light on the instrument panel alerts you if one or more tires is under- or over-inflated.

The Tire Pressure indicator light does not immediately turn off when you adjust tire pressure. After inflating the tire to the recommended pressure, you must drive over 25 km/h for more than 10 minutes to activate the Tire Pressure Monitoring System (TPMS), which turns off the Tire Pressure indicator light.

If the indicator light flashes for one minute whenever you power on Model S, a fault with the TPMS is detected (see [TPMS Malfunction on page 165](#)).

On newer vehicles, you can display tire pressures on the instrument panel by choosing to display **Car Status** using the right or left steering wheel buttons (see [Using Left Steering Wheel Buttons on page 39](#) or [Using Right Steering Wheel Buttons on page 40](#)). You can also choose whether you want to display tire pressures using BAR or PSI by touching **Controls > Display > Tire Pressure**.



WARNING: Under-inflation is the most common cause of tire failures and can cause a tire to overheat, resulting in severe tire cracking, tread separation, or blowout, which causes unexpected loss of vehicle control and increased risk of injury. Under-inflation also reduces the vehicle's range and tire tread life.



WARNING: Check tire pressures using an accurate pressure gauge when tires are cold. It takes only about 1.6 kms of driving to warm up the tires sufficiently to affect tire pressures. Parking the vehicle in direct sunlight or in hot weather can also affect tire pressures. If you must check warm tires, expect increased pressures. Do not let air out of warm tires in an attempt to match recommended cold tire pressures. A hot tire at or below the recommended cold tire inflation pressure is dangerously under-inflated.



WARNING: Do not use any tire sealant other than the type provided in a Tesla tire repair kit. Other types can cause tire pressure sensors to malfunction. If your Model S did not include a tire repair kit, you can purchase one from Tesla.

Checking and Adjusting Tire Pressures

Follow these steps when tires are cold and Model S has been stationary for over three hours:

1. Refer to the Tire and Loading Information label located on the driver's center door pillar for the target tire pressure.
2. Remove the valve cap.
3. Firmly press an accurate tire pressure gauge onto the valve to measure pressure.
4. If required, add or remove air to reach the recommended pressure.

NOTE: You can release air by pressing the metal stem in the center of the valve.
5. Re-check pressure using the accurate tire gauge.
6. Repeat steps 3 and 4 as necessary until the tire pressure is correct.
7. Reinstall the valve cap to prevent dirt from entering. Periodically check the valve for damage and leaks.

Inspecting and Maintaining Tires

Regularly inspect the tread and side walls for any sign of distortion (bulges), foreign objects, cuts or wear.



WARNING: Do not drive Model S if a tire is damaged, excessively worn, or inflated to an incorrect pressure. Check tires regularly for wear, and ensure there are no cuts, bulges or exposure of the ply/cord structure.



Tire Wear

Adequate tread depth is important for proper tire performance. Tires with a tread depth less than 3 mm are more likely to hydroplane in wet conditions and should not be used. Tires with a tread depth less than 4 mm do not perform well in snow and slush and should not be used when driving in winter conditions.

Model S is originally fitted with tires that have wear indicators molded into the tread pattern. When the tread has been worn down to 3 mm, the indicators start to appear at the surface of the tread pattern, producing the effect of a continuous band of rubber across the width of the tire. For optimal performance and safety, Tesla recommends replacing tires before the wear indicators are visible.

Tire Rotation, Balance, and Wheel Alignment

Tesla recommends rotating the tires every 10,000 km or if tread depth difference is 1.5 mm or greater, whichever comes first.

Unbalanced wheels (sometimes noticeable as vibration through the steering wheel) affect vehicle handling and tire life. Even with regular use, wheels can get out of balance. Therefore, they should be balanced as required.

If tire wear is uneven (on one side of the tire only) or becomes abnormally excessive, check the alignment of wheels.

NOTE: When replacing only two tires, install the new tires on the rear if your vehicle's front and rear tires are the same size.

Punctured Tires

A puncture eventually causes the tire to lose pressure, which is why it is important to check tire pressures frequently. Permanently repair or replace punctured or damaged tires as soon as possible.

Your tubeless tires may not leak when penetrated, provided the object remains in the tire. If, however, you feel a sudden vibration or ride disturbance while driving, or you suspect a tire is damaged, immediately reduce your speed. Drive slowly, while avoiding heavy braking or sharp steering and, when safe to do so, stop the vehicle. Arrange to have Model S transported to a Tesla Service Center, or to a nearby tire repair center.

NOTE: In some cases, you can temporarily repair small tire punctures (under 6 mm) using an optional tire repair kit available from Tesla. This allows you to slowly drive Model S to Tesla or to a nearby tire repair facility.



WARNING: Do not drive with a punctured tire that has not been repaired, even if the puncture has not caused the tire to deflate. A punctured tire can deflate suddenly at any time.

Flat Spots

If Model S is stationary for a long period, tires can form flat spots. When Model S is driven, these flat spots cause a vibration which gradually disappears as the tires warm up and regain their original shape.

To minimize flat spots during storage, inflate tires to the maximum pressure indicated on the tire wall. Then, before driving, release air to adjust tire pressure to the recommended levels.

Improving Tire Mileage

To improve the mileage you get from your tires, maintain tires at the recommended tire pressures, observe speed limits and advisory speeds, and avoid:

- Pulling away quickly, or hard acceleration.
- Fast turns and heavy braking.
- Potholes and objects in the road.
- Hitting curbs when parking.
- Contaminating tires with fluids that can cause damage.

Replacing Tires and Wheels

Tires degrade over time due to the effects of ultraviolet light, extreme temperatures, high loads, and environmental conditions. It is recommended that tires are replaced every six years, or sooner if required, even if tread depth is above the minimum.

Wheel and tires are matched to suit the handling characteristics of the vehicle. Replacement tires must comply with the original specification. If tires other than those specified are used, ensure that the load and speed ratings marked on the tire (see [Understanding Tire Markings on page 186](#)) equal or exceed those of the original specification.

Ideally, you should replace all four tires at the same time. If this is not possible, replace the tires in pairs, placing the new tires on the rear. Always balance the wheel and tire after replacing a tire.

If you replace a wheel, the TPMS (Tire Pressure Monitoring System) sensors need to be reset to ensure they provide accurate warnings when tires are under- or over-inflated (see [Resetting the TPMS Sensors on page 164](#)).

For the specification of the original wheels and tires installed on Model S, see [Wheels and Tires on page 184](#).



WARNING: For your safety, use only tires and wheels that match the original specification. Tires that do not match the original specification can affect the operation of the TPMS.



Tire Care and Maintenance

WARNING: Never exceed the speed rating of your vehicle's tires. The speed rating is shown on the sidewall of your tires (see [Understanding Tire Markings on page 186](#)).

Asymmetric Tires

Model S tires are asymmetric and must be mounted on the wheel with the correct sidewall facing outward. The sidewall of the tire is marked with the word **OUTSIDE**. When new tires are installed, make sure that the tires are correctly mounted on the wheels.



WARNING: Road holding is seriously impaired if the tires are incorrectly installed on the wheels.

Wheel Configuration

If you are installing new wheels or swapping them for different ones, update your vehicle's wheel configuration by touching **Controls > Service > Wheel Configuration**. This allows Model S to learn the new wheels and provide more accurate status updates on your vehicle. Select a wheel from the drop down menu that matches the new wheels you plan to install on Model S. Selecting new wheels in the wheel configuration also changes the wheels that appear on your vehicle's avatar on the touchscreen.

Ensure you are aware if your vehicle is equipped with staggered wheels, meaning the wheels are different sizes in the front and rear. Check the front and rear tire sizes marked on the tire sidewall to see if they match or are different sizes. If the wheels are staggered, take extra precaution to ensure the new wheels you install are staggered in the same way as the previous wheels.

NOTE: Changing your vehicle's wheel configuration can impact range estimates, tire pressure warning levels, and vehicle visualization.

WARNING: Only use Tesla-approved wheels when installing or swapping wheels. Using non Tesla-approved wheels can cause serious damage. Tesla is not liable for damage caused by using wheels not approved by Tesla.

Tire Pressure Monitoring

Each tire should be checked monthly when cold and inflated to the recommended pressures that are printed on the Tire and Loading Information label located on the driver's door pillar (see [Maintaining Tire Pressures on page 162](#)). If your vehicle has tires of a different size

than the size indicated on the vehicle placard or tire inflation pressure label, determine the proper tire inflation pressure for those tires.

As an added safety feature, your vehicle has been equipped with a TPMS that displays a tire pressure telltale (Tire Pressure Warning) on the instrument panel when one or more of your tires is significantly under- or over-inflated. Accordingly, when the Tire Pressure indicator light displays on the instrument panel to alert you about tire pressure, stop and check your tires as soon as possible, and inflate them to the proper pressure (see [Maintaining Tire Pressures on page 162](#)). Driving on a significantly under-inflated tire causes the tire to overheat and can lead to tire failure. Under-inflation also reduces range efficiency and tire tread life, and may affect the vehicle's handling and stopping ability.



If Model S detects a fault with the TPMS, this indicator flashes for one minute whenever you power on Model S.

NOTE: Installing accessories that are not approved by Tesla can interfere with the TPMS.

WARNING: The TPMS is not a substitute for proper tire maintenance, including manually checking tire pressures and regularly inspecting the condition of tires. It is the driver's responsibility to maintain correct tire pressure, even if under- or over-inflation has not reached the level for the TPMS to trigger the Tire Pressure Warning on the instrument panel.

Resetting the TPMS Sensors

After replacing one or more wheels (but not after replacing a tire or rotating wheels), the TPMS sensors need to be reset to ensure tire pressure warnings are accurate.

On newer versions of Model S, the TPMS sensors are reset automatically after driving over 25 km/h for longer than 10 minutes. But for older versions, follow these steps:

1. Inflate all tires to their recommended pressures, as indicated on the Tire and Loading Information label located on the door pillar.
2. Get ready to drive for ten minutes, then touch **Controls > Service > Reset TPMS**.
3. Follow the onscreen instructions.



⚠ CAUTION: Selecting the incorrect wheel size may result in false tire pressure warnings. If a tire pressure warning displays, exit the vehicle, close the rear trunk and all doors, wait for the touchscreen to go black, then re-enter the vehicle and ensure that the correct wheel size is selected before touching **Reset TPMS**.

NOTE: On some older versions of Model S, when changing to 21" wheels, the TPMS may generate false tire pressure warnings. Bring Model S to a Tesla Service Center for further adjustment.

⚠ WARNING: Do not reset the TPMS sensors in an attempt to clear tire pressure warnings.

Replacing a Tire Sensor

If the Tire Pressure warning indicator displays frequently, contact Tesla to determine if a tire sensor needs to be replaced. If a non-Tesla Service Center repairs or replaces a tire, the tire sensor may not work until Tesla performs the setup procedure.

TPMS Malfunction

Model S has also been equipped with a TPMS malfunction indicator to indicate when the system is not operating properly.



The TPMS malfunction indicator is combined with the tire pressure indicator light. When the system detects a malfunction, the indicator flashes for approximately one minute, then remains continuously lit. This sequence continues upon subsequent vehicle start-ups as long as the malfunction exists. When the TPMS malfunction indicator is on, the system might not be able to detect or signal under- or over-inflated tires as intended.

TPMS malfunctions can occur for a variety of reasons, including installing replacement or alternate tires or wheels that prevent the TPMS from functioning properly. Always check the TPMS malfunction indicator light after replacing one or more tires or wheels on your vehicle to ensure that the replacement tires or wheels allow the TPMS to continue to function properly.

NOTE: If a tire has been replaced or repaired using a different tire sealant than the one available from Tesla, and a low tire pressure is detected, it is possible that the tire sensor has been damaged. Contact Tesla to have the fault repaired as soon as possible.

Seasonal Tire Types

Summer Tires

Your vehicle may be originally equipped with high performance summer tires or all season tires. Tesla recommends using winter tires if driving in cold temperatures or on roads where snow or ice may be present. Contact Tesla for winter tire recommendations.

⚠ WARNING: In cold temperatures or on snow or ice, summer tires do not provide adequate traction. Selecting and installing the appropriate tires for winter conditions is important to ensure the safety and optimum performance of your Model S.

All-Season Tires

Your Model S may be originally equipped with all-season tires. These tires are designed to provide adequate traction in most conditions year-round, but may not provide the same level of traction as winter tires in snowy or icy conditions. All-season tires can be identified by "ALL SEASON" and/or "M+S" (mud and snow) on the tire sidewall.

Winter Tires

Use winter tires to increase traction in snowy or icy conditions. When installing winter tires, always install a complete set of four tires at the same time. Winter tires must be the same diameter, brand, construction and tread pattern on all four wheels. Contact Tesla for winter tire recommendations.



Winter tires can be identified by a mountain/snowflake symbol on the tire's sidewall.

When driving with winter tires, you may experience more road noise, shorter tread life, and less traction on dry roads.

Driving in Low Temperatures

Tire performance is reduced in low ambient temperatures, resulting in reduced grip and an increased susceptibility to damage from impacts. Performance tires can temporarily harden when cold, causing you to hear rotational noise for the first few kilometers until the tires warm up.



Using Tire Chains

Tesla has tested and approved Maggie Group Trak Sport P217 tire chains to increase traction in snowy conditions. These chains should only be installed on rear 19" tires. Do not use chains on 21" tires or on front tires. The approved tire chains can be purchased from Tesla.

When installing tire chains, follow the instructions and warnings provided by the tire chain manufacturer. Mount them evenly and as tight as possible.

When using tire chains:

- Inspect the tire chains for loose fittings and damaged links before each use.
- Ensure air suspension is set to STANDARD and Suspension Lowering is set to NEVER for vehicles equipped with air suspension (see [Air Suspension on page 138](#)).
- Avoid heavily loading Model S (heavy loads can reduce the clearance between the tires and the body).
- Do not drive the vehicle without the chains properly installed.
- Drive slowly. Do not exceed 48 km/h.
- Remove the tire chains as soon as conditions allow.

NOTE: Tire chains are prohibited in some jurisdictions. Check local laws before installing tire chains.

 **CAUTION:** Vehicles equipped with air suspension should remain in the STANDARD ride height setting to avoid damage.

 **CAUTION:** Using non-recommended tire chains, or using tire chains on other sized tires can damage the suspension, body, wheels, and/or brake lines. Damage caused by using non-recommended tire chains, or incorrectly installing tire chains, is not covered by the warranty.

 **CAUTION:** Do not use chains on a Model S equipped with 21" tires and do not use tire chains on front tires.

 **CAUTION:** Never deflate your tires to put on tire chains. When re-inflated, the chains might fit too tightly and cause tire damage.

 **CAUTION:** Ensure that the tire chains cannot touch suspension components or brake lines. If you hear the chains making unusual noises that would indicate contact with Model S, stop and investigate immediately.

Cleaning the Exterior

To prevent damage to the paint, immediately remove corrosive substances (bird droppings, tree resin, dead insects, tar spots, road salt, industrial fallout, etc.). Do not wait until Model S is due for a complete wash. If necessary, use denatured alcohol to remove tar spots and stubborn grease stains, then immediately wash the area with water and a mild, non-detergent soap to remove the alcohol.

Keep the exterior cameras free of dirt, condensation, or obstructions. Occasionally remove any buildup of dirt by wiping the components with a soft cloth dampened with warm water. These substances can cause autopilot and safety features to stop working (see [Cleaning Cameras and Sensors on page 81](#)).

Follow these steps when washing the exterior of Model S:

1. Rinse Thoroughly

Before washing, flush grime and grit from the vehicle using a hose. Flush away accumulations of mud in areas where debris easily collects (such as wheel wells and panel seams). If salt has been used on the highways (such as during winter months), thoroughly rinse all traces of road salt from the underside of the vehicle, wheel wells, and brakes.

2. Hand Wash

Hand wash Model S using a clean soft cloth and cold or lukewarm water containing a mild, high-quality car shampoo.

 **CAUTION:** Some cleaners and car shampoos contain chemicals that can cause damage or discoloration, especially to plastic trim pieces, lamps, or camera lenses. For example, some car cleaning formulas contain hydroxide or other highly alkaline or caustic ingredients that can damage exterior components. Damage or discoloration resulting from cleaning products is not covered by the warranty.

3. Rinse with Clean Water











After washing, rinse with clean water to prevent soap from drying on the surfaces.

4. Dry Thoroughly and Clean Exterior Glass

After washing and rinsing, dry thoroughly with a chamois. If necessary, dry the brakes by going on a short drive and applying the brakes multiple times.

Clean windows and mirrors using an automotive glass cleaner. Do not scrape, or use any abrasive cleaning fluid on glass or mirrored surfaces.

Cautions for Exterior Cleaning

-  **CAUTION:** Do not wash in direct sunlight.
-  **CAUTION:** Do not use windshield treatment fluids. Doing so can interfere with wiper friction and cause a chattering sound.
-  **CAUTION:** Do not use hot water, detergents, or highly alkaline or caustic cleaning products, especially those containing hydroxide.
-  **CAUTION:** If using a pressure washer, maintain a distance of at least 30 cm between the nozzle and the surface of Model S. Avoid aiming the water jet directly on the camera(s) or parking sensors (if equipped). Also do not clean a sensor or camera lens with a sharp or abrasive object that can scratch or damage its surface. Keep the nozzle moving and do not concentrate the water jet on any one area.
-  **CAUTION:** Do not aim water hoses directly at windows, door, or hood seals or at electronic modules or exposed cabling.
-  **CAUTION:** To avoid corrosive damage that may not be covered by the warranty, rinse away any road salt from the underside of the vehicle, wheel wells, and brakes. After cleaning the vehicle, dry the brakes by going on a short drive and applying the brakes multiple times.
-  **CAUTION:** Avoid using tight-napped or rough cloths, such as washing mitts. A high-quality microfiber cleaning cloth is recommended.
-  **CAUTION:** If washing in an automatic car wash, use touchless car washes only. These car washes have no parts (brushes, etc.) that touch the surfaces of Model S. Some touchless car washes use caustic solutions that, over time, can cause discoloration of decorative exterior trim. Avoid exposure to soaps and chemicals above pH 13. If unsure, check the product label or ask the staff at the car wash. Damage caused by improper washing is not covered by the warranty.
-  **CAUTION:** Ensure the wipers are off before washing Model S to avoid the risk of damaging the wipers.
-  **CAUTION:** Do not use chemical based wheel cleaners or pre-wash products. These can damage the finish on the wheels.
-  **WARNING:** Never spray liquid at a high velocity (for example, if using a pressure washer) towards the charge port while Model S is charging. Failure to follow these instructions can result in serious injury or damage to the vehicle, charging equipment, or property.

Cleaning the Interior

Frequently inspect and clean the interior to maintain its appearance and to prevent premature wear. If possible, immediately wipe up spills and remove marks. For general cleaning, wipe interior surfaces using a soft cloth (such as microfiber) dampened with a mixture of warm water and mild non-detergent cleaner (test all cleaners on a concealed area before use). To avoid streaks, dry immediately with a soft lint-free cloth.

Interior Glass

Do not scrape, or use any abrasive cleaning fluid on glass or mirrored surfaces. This can damage the reflective surface of the mirror and the heating elements in the rear window.

Airbags

Do not allow any substance to enter an airbag cover. This could affect correct operation.

Dashboard and Plastic Surfaces

Do not polish the upper surfaces of the dashboard. Polished surfaces are reflective and could interfere with your driving view.

Leather Seats

Leather is prone to dye-transfer which can cause discoloration, particularly on light colored leather. White and tan leather is coated with an anti-soiling treatment. Wipe spills as soon as possible using a soft cloth moistened with warm water and non-detergent soap. Wipe gently in a circular motion. Then wipe dry using a soft, lint-free cloth. Using detergents or commercially available leather cleaners and conditioners is not recommended because they can discolor or dry out the leather.

Polyurethane Seats

Wipe spills as soon as possible using a soft cloth moistened with warm water and non-detergent soap. Wipe gently in a circular motion. After cleaning, allow the seats to air dry.

Be careful with dyes, such as from clothing or denim, that come into contact with the seats. Dyes can diffuse into the seat material over time and cause staining.

 **CAUTION:** Aftermarket, non-Tesla seat covers may inhibit the sensitivity of seat sensors and may cause staining or damage.

Cloth Seats

Wipe spills as soon as possible using a soft cloth moistened with warm water and non-detergent soap. Wipe gently in a circular motion. Then wipe dry using a soft, lint-free cloth. Vacuum the seats as needed to remove any loose dirt.

Carpets

Avoid over-wetting carpets. For heavily soiled areas, use a diluted upholstery cleaner.

Seat Belts

Extend the belts to wipe. Do not use any type of detergent or chemical cleaning agent. Allow the belts to dry naturally while extended, preferably away from direct sunlight.





Touchscreen and Instrument Panel

Clean the touchscreen and instrument panel using a soft lint-free cloth specifically designed to clean monitors and displays. Do not use cleaners (such as a glass cleaner) and do not use a wet wipe or a dry statically-charged cloth (such as a recently washed microfiber). To wipe the touchscreen without activating buttons and changing settings, you can enable Screen Clean Mode. Touch **Controls > Display > Screen Clean Mode**. The display darkens to make it easy to see dust and smudges. To exit Screen Clean Mode, press and hold **HOLD TO EXIT**.

Chrome and Metal Surfaces

Polish, abrasive cleaners or hard cloths can damage the finish on chrome and metal surfaces.

Cautions for Interior Cleaning

-  **CAUTION:** Using solvents (including alcohol), bleach, citrus, naphtha, or silicone-based products or additives on interior components can cause damage.
-  **CAUTION:** Statically-charged materials can cause damage to the touchscreen or instrument panel.
-  **WARNING:** If you notice any damage on an airbag or seat belt, contact Tesla immediately.
-  **WARNING:** Do not allow any water, cleaners, or fabric to enter a seat belt mechanism.
-  **WARNING:** Exposure to chemical cleaners can be hazardous and can irritate eyes and skin. Read and observe the instructions provided by the manufacturer of the chemical cleaner.

Polishing, Touch Up, and Body Repair

To preserve the cosmetic appearance of the body, you can occasionally treat the paint surfaces with an approved polish containing:

- Very mild abrasive to remove surface contamination without removing or damaging the paint.
- Filling compounds that fill scratches and reduce their visibility.
- Wax to provide a protective coating between the paint and environmental elements.

Regularly inspect the exterior paint for damage. Treat minor chips and scratches using a paint touch-up pen (available for purchase from Tesla). Use the touch-up pen after washing but before polishing or waxing.

Repair rock chips, fractures or scratches. Refer to <https://www.tesla.com/support/body-shop-support> for more information on repair locations and available services.

 **CAUTION:** Do not use cutting pastes, color restoration compounds, or polishes containing harsh abrasives. These can scour the surface and permanently damage the paint.

 **CAUTION:** Do not use chrome polish or other abrasive cleaners.

Using a Car Cover

To preserve the cosmetic appearance of the body when Model S is not being used, use a genuine Tesla car cover. Car covers can be purchased from Tesla. See [Parts and Accessories on page 175](#).

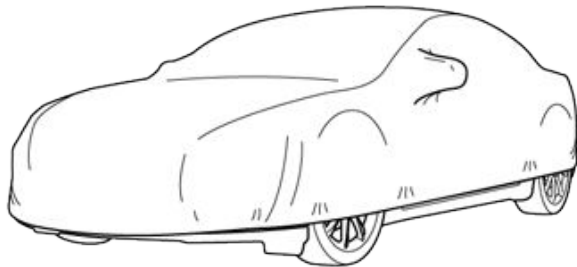

 **CAUTION:** Use only a Tesla-approved car cover when Model S is plugged in. Using a non-Tesla car cover can prevent the Battery from being adequately cooled during charging.

Floor Mats

To extend the life of your carpet and make them easier to clean, use genuine Tesla floor mats (see [Parts and Accessories on page 175](#)). Maintain floor mats by regularly cleaning them and checking that they are properly attached. Replace floor mats if they become excessively worn.

 **WARNING:** To avoid potential interference with a foot pedal, ensure that the driver's floor mat is securely fastened, and never place an additional floor mat on top of it. Floor mats should always rest on top of the vehicle carpeting surface and not on another floor mat or other covering.



Wiper Blades and Washer Jets

Checking and Cleaning Wiper Blades

Periodically clean the edge of the wiper blades and check the rubber for cracks, splits, and roughness. If damaged, replace the blade immediately to prevent damage to the glass and improve visibility.

Contaminants on the windshield, or on the wiper blades, can reduce the effectiveness of the wipers. Contaminants include ice, wax spray from car washes, washer fluid with bug and/or water repellent, bird droppings, tree sap, and other organic substances.

Follow these guidelines for cleaning:

- Clean the windshield and wiper blades using washer fluid, isopropyl (rubbing) alcohol, or non-abrasive glass cleaner approved for use on automotive glass and rubber. Inappropriate products can cause damage or smears, and create glare on the windshield.
- Lift the wiper arm a short distance away from the windshield, just far enough to access the wiper blade. Do not lift a wiper arm beyond its intended position.

If the wipers remain ineffective after cleaning, replace the wiper blades.

Replacing Wiper Blades

For optimum performance, replace the wiper blades at least once a year.

NOTE: Only install replacement blades that are identical to the original blades. Using inappropriate blades can affect the operation of the rain sensor and damage the wiper system and windshield.

To replace the wiper blades:

1. Shift into Park and turn off the wipers.
2. Touch **Controls > Service > Wiper Service Mode > ON** to move the wipers to the service position.
3. Lift the wiper arm a short distance away from the windshield, just far enough to access the wiper blade.



CAUTION: Wiper blades do not lock into a lifted position. Do not lift a wiper arm beyond its intended position.

4. Place a towel between the wiper arm and windshield to avoid scratching or cracking the windshield.
5. Hold the wiper arm and press the locking tab while sliding the blade down the arm.

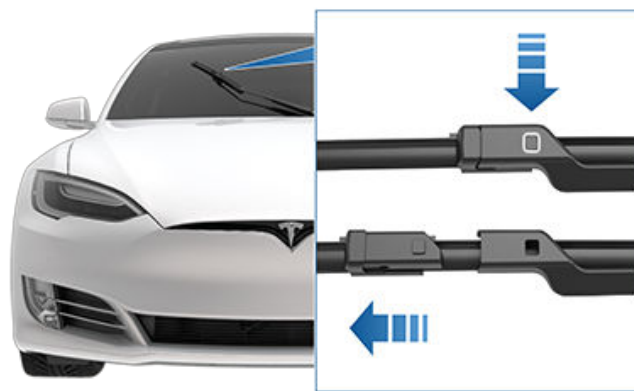

6. Align the new wiper blade on the wiper arm and slide it toward the end of the wiper arm until it locks into place.
7. Turn Wiper Service Mode off to return the wipers to their normal position.

Cleaning Washer Jets

The position of the windshield washers is set at the factory and should never need adjusting.

If a windshield washer becomes blocked, use a thin strand of wire to clear any blockages from the nozzles.

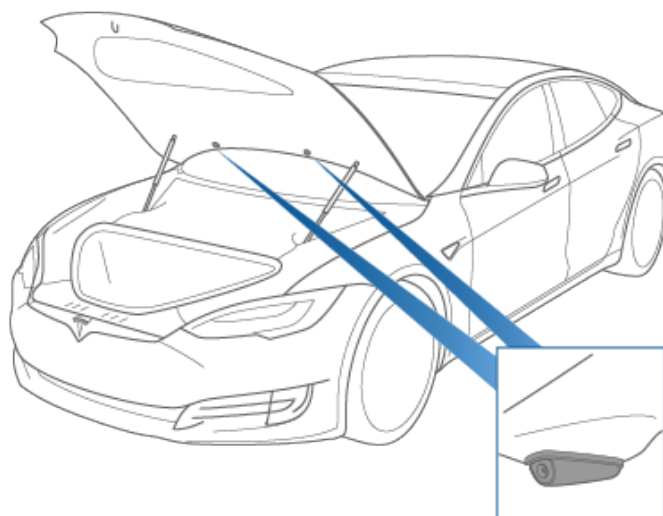

WARNING: Do not operate the washers while cleaning Model S. Windshield washer fluid can irritate eyes and skin. Read and observe the washer fluid manufacturer's instructions.

Removing the Maintenance Panel

To check fluid levels, remove the maintenance panel:

1. Open the hood.
2. Pull the maintenance panel upward to release the clips that hold it in place.



⚠ CAUTION: The maintenance panel protects the front trunk from water. When re-attaching, make sure it is fully seated.

Checking Battery Coolant

Your Battery coolant should not need to be replaced for the life of your vehicle under most circumstances. However, if the quantity of fluid in the cooling system drops below the recommended level, the instrument panel displays a warning message. Stop driving Model S as soon as safety permits and contact Tesla.

Fluid Level Check

On a Rear Wheel Drive Model S, you can check the fluid level visually. **BUT DO NOT REMOVE THE FILLER CAP AND DO NOT ADD FLUID.** Doing so can result in damage not covered by the warranty. To check the fluid level, park Model S on level ground. When Model S is cool, remove the maintenance panel (see [Removing the Maintenance Panel on page 171](#)). The fluid level can be seen by looking at the outside marks on the side of the reservoir.

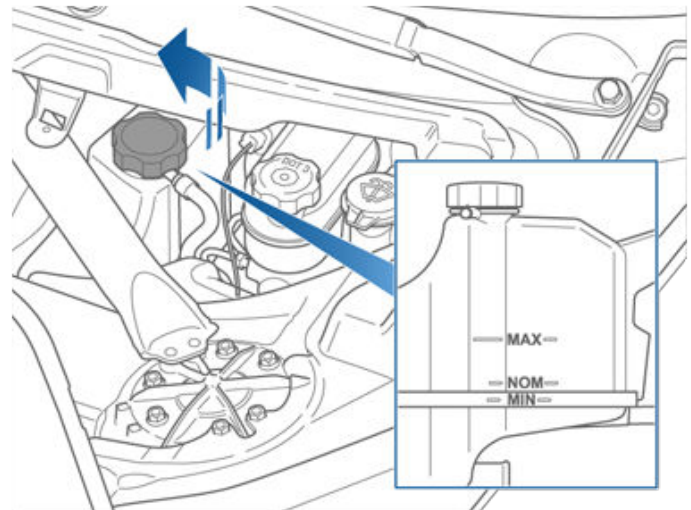

The fluid level should be between the **MIN** and the **MAX** marks. If you notice that the fluid level has dropped significantly, contact Tesla before using Model S.

Do Not Top Up Battery Coolant

⚠ WARNING: Battery coolant can be hazardous and can irritate eyes and skin. Under no circumstances should you remove the filler cap and/or add coolant. If the instrument panel warns you that the fluid level is low, contact Tesla immediately.

To maximize the performance and life of the Battery, the cooling system uses a specific mixture of G-48 ethylene-glycol coolant (HOAT). Contact Tesla for more specific information about the coolant.

Checking Brake Fluid

⚠ WARNING: Contact Tesla immediately if you notice increased movement of the brake pedal or a significant loss of brake fluid. Driving under these conditions can result in extended stopping distances or complete brake failure.



A red brake indicator on the instrument panel alerts you if the quantity of fluid in the brake reservoir drops below the recommended level. If it displays while driving, stop as soon as safety permits by gently applying the brakes. Do not continue driving. Contact Tesla immediately.

Fluid Level Check

Tesla checks the brake fluid level and health at the regularly scheduled maintenance intervals. To check the fluid level yourself, park Model S on level ground. When Model S is cool, remove the maintenance panel (see [Removing the Maintenance Panel on page 171](#)).



Fluid Reservoirs

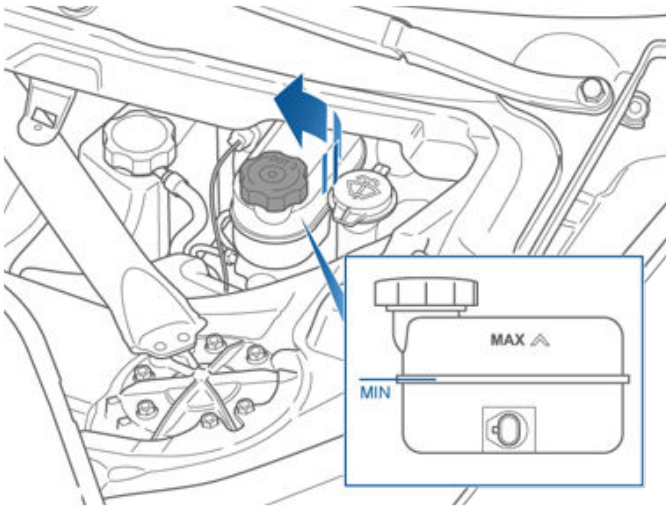

Check the fluid level visually by looking at the outside marks on the side of the reservoir without removing the filler cap.

The brake fluid level should always be between the **MIN** and the **MAX** marks.

NOTE: Although brake fluid level drops slightly during normal use as a result of brake pad wear, it should not drop below the MIN mark.

Topping Up the Brake Fluid

Do not top up your brake fluid. The following instructions are provided for information purposes and future reference only:

1. Clean the filler cap before removing it to prevent dirt from entering the reservoir.
2. Unscrew the cap and remove it.
3. Top up the reservoir to the **MAX** mark using the appropriate brake fluid.
4. Replace the filler cap, ensuring it is fully secured.

WARNING: Only use new fluid from a sealed airtight container. Never use previously used fluid or fluid from a previously opened container—fluid absorbs moisture which decreases braking performance.

WARNING: Brake fluid is highly toxic. Keep containers sealed and out of the reach of children. In the event of accidental consumption, seek medical attention immediately.

CAUTION: Brake fluid damages painted surfaces. Immediately soak up any spills with an absorbent cloth and wash the area with a mixture of car shampoo and water.

Topping Up Windshield Washer Fluid

The only reservoir into which you can add fluid is the windshield washer fluid reservoir, which is located behind the front trunk. When the level is low, a message displays on the instrument panel.

To top up the washer fluid:

1. Open the hood.
2. Clean around the filler cap before opening it to prevent dirt from entering the reservoir.
3. Open the filler cap.

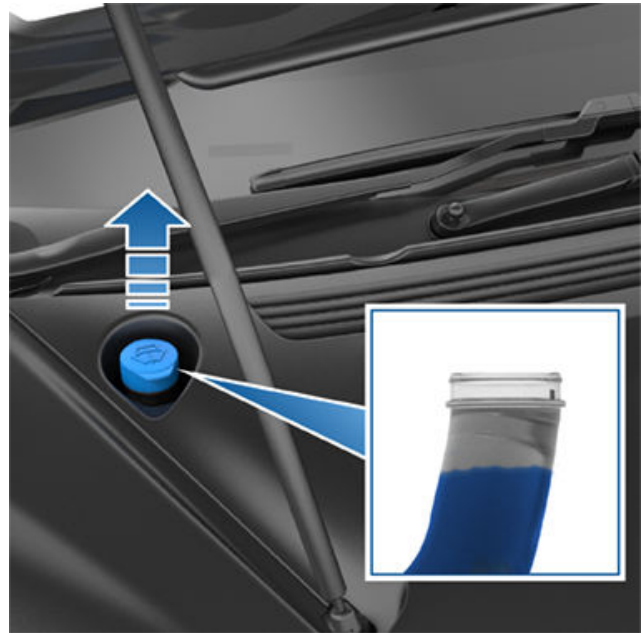

4. While avoiding spilling, fill the reservoir until the fluid level is visible just below the filler neck.
5. Wipe up any spills immediately and wash the affected area with water.
6. Replace the filler cap.

NOTE: Some national or local regulations restrict the use of Volatile Organic Compounds (VOCs). VOCs are commonly used as antifreeze in washer fluid. Use a washer fluid with limited VOC content only if it provides adequate freeze resistance for all climates in which you drive Model S.

CAUTION: Do not add formulated washer fluids that contain water repellent or bug wash. These fluids can cause streaking, smearing, and squeaking or other noises.

WARNING: In temperatures below 4° C, use a washer fluid with antifreeze. In cold weather, using a washer fluid without antifreeze can impair visibility through the windshield.



 **WARNING:** Windshield washer fluid can irritate eyes and skin. Read and observe the instructions provided by the washer fluid manufacturer.

Jacking Procedure

Follow the steps below to lift Model S. Ensure that any non-Tesla repair facility is aware of these lifting points.

1. Position Model S centrally between the lift posts.
2. If your Model S is equipped with air suspension, it automatically self-levels, even when power is off (see [Jack Mode on page 174](#)). Use the touchscreen to set the suspension as follows:
 - Touch **Controls** > **Suspension**.
 - Press the brake pedal, then touch **Very High** to maximize the height of the suspension.
 - Touch **Controls** > **Service** > **Jack Mode** to disable self-leveling.
3. Position the lift arm pads under the designated body lift points at the locations shown.

 **WARNING: DO NOT** position the lift arm pads under the Battery or side rails, as shown in red.

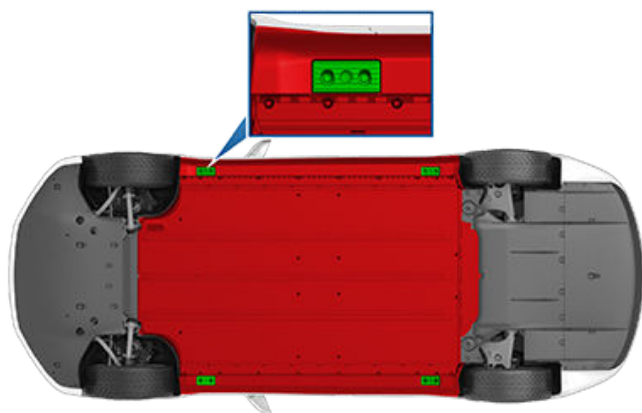



4. Adjust the height and position of the lift arm pads to ensure that they are correctly located.
5. With assistance, raise the lift to the desired height, ensuring the lift arm pads remain in their correct positions.
6. Engage any lift safety locks. Follow the lift manufacturer's instructions.

NOTE: Jack mode cancels when Model S is driven over 7 km/h.

NOTE: Jack mode may be unexpectedly enabled in situations where an object is supporting the vehicle's weight (for example the bumper of the vehicle is resting on a curb).

 **WARNING:** If your Model S is equipped with air suspension, it automatically self-levels, even when power is off. You **MUST** disable this system by engaging Jack mode before lifting or jacking. If you do not disable air suspension, Model S can attempt to self-level, causing serious damage, bodily injury, or death.

 **WARNING:** Never raise Model S when the charge cable is connected, even if charging is not in progress.

 **WARNING:** Do not work on an incorrectly supported vehicle. Doing so can cause serious damage, bodily injury, or death.

 **CAUTION:** **DO NOT** lift from under the Battery or side rails. Place the lift arm pads under the designated body lift points only. The locations shown are the only approved lifting points for Model S. Lifting at any other points can cause damage. Damage caused by incorrectly lifting Model S is not covered by the warranty.

Jack Mode

If Model S is equipped with air suspension, it automatically self-levels, even when power is off. To prevent damage when jacking or lifting the vehicle, you must activate Jack Mode to disable self-leveling. Jack mode prevents the self-leveling that occurs even when Model S is powered off.

Press the brake pedal, then touch **Controls** > **Service** > **Jack Mode**.

To deactivate, touch **Jack** again.

NOTE: Jack mode automatically cancels when you drive over 7 km/h.

NOTE: Model S also sets Jack mode automatically if it detects that the vehicle cannot lower to its target height, or if it detects that an object is supporting the vehicle's weight (for example the bumper of the vehicle is resting on a curb).



Parts, Accessories, and Modifications

Use only genuine Tesla parts and accessories. Tesla performs rigorous testing on parts to ensure their suitability, safety, and reliability. Purchase these parts from Tesla, where they are professionally installed and where you can receive expert advice about modifications to Model S. Accessories are available for purchase from Tesla stores or online at www.tesla.com/en_AU.

NOTE: Some accessories may not be available in your market region.

Tesla is unable to assess parts manufactured by other distributors and therefore accepts no responsibility if you use non-Tesla parts on Model S.

- ⚠ WARNING:** Installing non-approved parts and accessories, or performing non-approved modifications, can affect the performance of Model S and the safety of its occupants. Any damage caused by using or installing non-approved parts, or by performing non-approved modifications, is not covered by the warranty.
- ⚠ WARNING:** Tesla does not accept liability for death, personal injury or damage that occurs if you use or install non-approved accessories or make non-approved modifications.

Body Repairs

If your Model S is in a collision, contact Tesla or a Tesla-approved Body Shop to ensure that it is repaired with genuine Tesla parts. Tesla has selected and approved body shops that meet strict requirements for training, equipment, quality, and customer satisfaction.

Some repair shops and insurance companies might suggest using non-original equipment or salvaged parts to save money. However, these parts do not meet Tesla's high standards for quality, fit and corrosion resistance. In addition, non-original equipment and salvaged parts (and any damage or failures they might cause) are not covered by the warranty.

Using RFID Transponders

Model S has a metallic coating on the windshield that can interfere with signals sent from RFID transponders used by many toll systems. Most Model S vehicles, depending on date of manufacture, include an area in the windshield in which the metallic coating is cut out to accommodate transponders. This area, located on the right side of the rear view mirror, is the best location to mount a transponder. If your vehicle does not include this cut out area, mount the transponder to the rear window.

NOTE: You can also attach a weather-proof transponder to the front license plate.

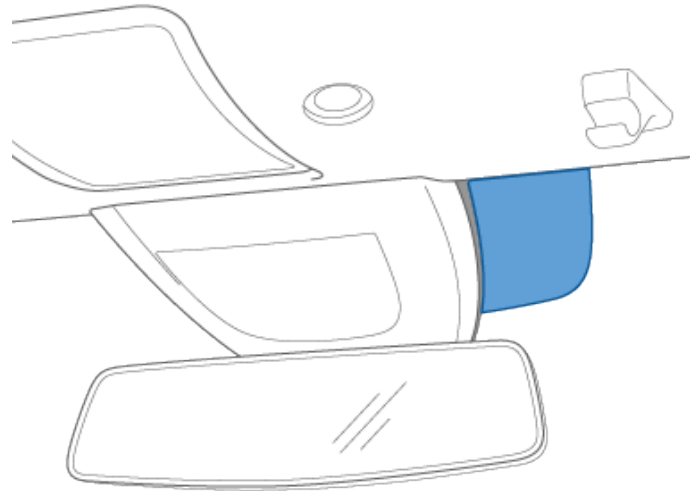



Identification Labels

Vehicle Identification Number

You can find the VIN at the following locations:

- Touch the Tesla "T" at the top center of the touchscreen. The popup window displays the VIN.
- Stamped on a plate located at the top of the dashboard. Can be seen by looking through the windshield.
- Printed on the Identification Plate, located on the door pillar. Can be seen when the front door is open.

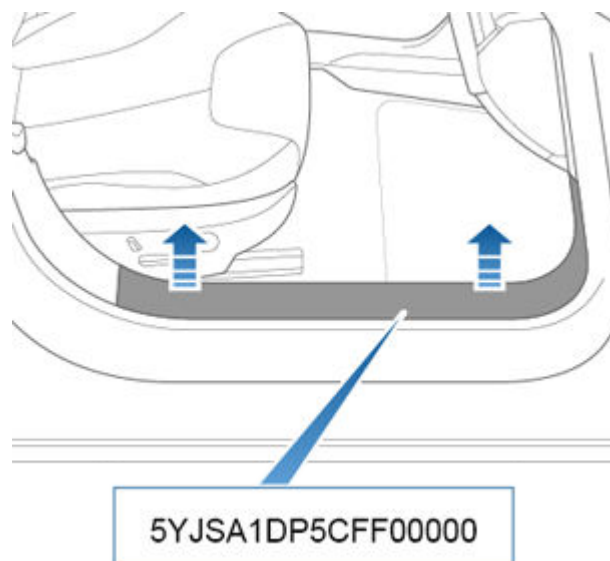
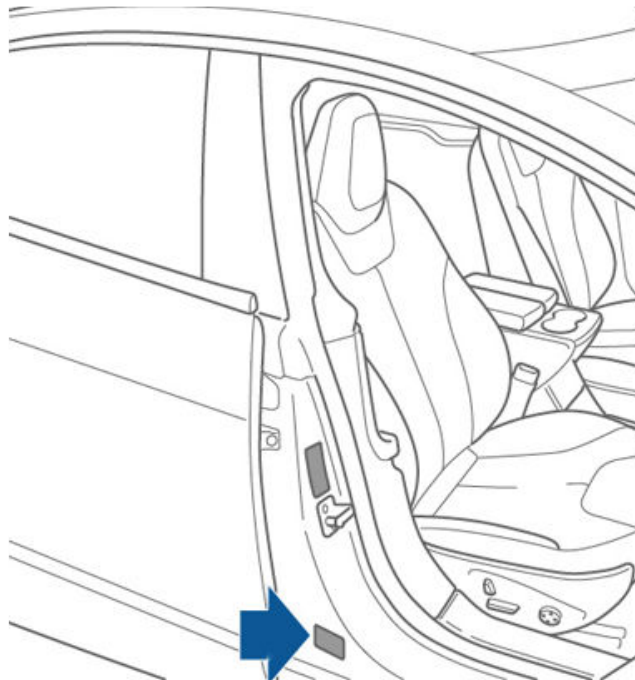

- On vehicles manufactured as of August 2015, the VIN is stamped on the chassis and can be seen by removing the sill panel on the driver's door by gently prying it upward using a flat-bladed tool.

⚠ CAUTION: Removing the sill panel to view the VIN is not recommended because damage is likely to occur. The panel is held in place with fragile clips that break easily. Damage caused by removing the sill panel is not covered by the warranty.



Load Capacity Labeling

It is important to understand how much weight your Model S can safely carry. This weight is called the vehicle capacity weight and includes the weight of all occupants, cargo and any additional equipment added to your Model S since it was manufactured.

Two labels attached to the center door pillar indicate how much weight Model S can safely carry. Labels are visible when the front door is open.

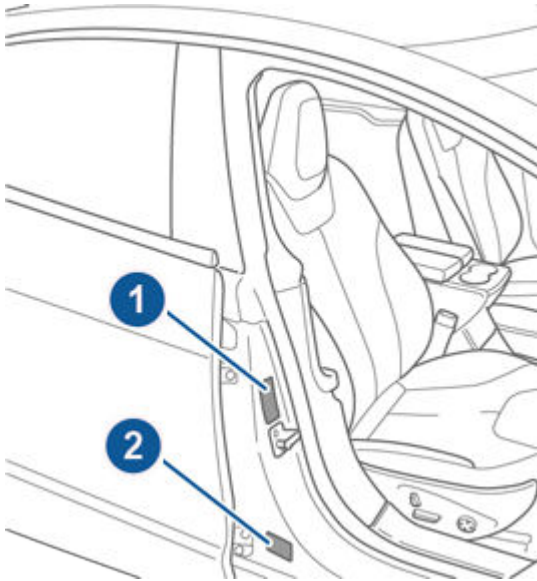

1. Tire and Loading Information Label
2. Identification Plate

- ⚠ WARNING:** Overloading Model S has an adverse effect on braking and handling, which can compromise your safety or cause damage.
- ⚠ CAUTION:** Never load more than 300 lbs (136 kg) in the front trunk. Doing so can cause damage.
- ⚠ CAUTION:** Never load more than 175 lbs (80 kg) on the rear load floor (above the lower trunk compartment) or more than 285 lbs (130 kg) in the lower trunk compartment. Doing so can cause damage.
- ⚠ CAUTION:** Never store large amounts of liquid in Model S. A significant spill can cause electrical components to malfunction.

Tire and Loading Information Label

The Tire and Loading Information label provides:

- The maximum number of occupant seating positions.
- The maximum vehicle capacity weight.
- The size of the original tires.

- The cold inflation pressures for the original front and rear tires. These pressures are recommended to optimize ride and handling characteristics.

TIRE AND LOADING INFORMATION RENSEIGNEMENTS SUR LES PNEUS ET LE CHARGEMENT			
SEATING CAPACITY/NOMBRE DE PLACES - TOTAL 5 FRONT/AVANT 2 REAR/ARRIÈRE 3			
THE COMBINED WEIGHT OF OCCUPANTS AND CARGO SHOULD NEVER EXCEED xxx KG OR xxx LBS LE POIDS TOTAL DES OCCUPANTS ET DU CHARGEMENT NE DOIT JAMAIS DÉPASSER xxx KG OU xxx LBS			
TIRE/PNEU	FRONT/AVANT	REAR/ARRIÈRE	SPARE/DE SECOURS
ORIGINAL TIRE SIZE/ TAILLE DES PNEUS D'ORIGINE	XXXX/XXXXX	XXXX/XXXXX	NONE/AUCUN
COLD TIRE PRESSURE/ PRESSION DES PNEUS À FROID	xxx kPa, xx psi	xxx kPa, xx psi	NONE/AUCUN

SEE OWNER'S MANUAL FOR ADDITIONAL INFORMATION. VOIR LE MANUEL DE L'USAGER POUR PLUS DE RENSEIGNEMENTS.

Never change this label, even if you use different tires in the future.

NOTE: If Model S is loaded to its full capacity, double check all tires to ensure they are inflated to their recommended pressure levels.

Identification Plate

In addition to the VIN, the Identification Plate provides certification that Model S complies with the Motor Vehicle Standards Act.

APPROVAL No: 46163	CATEGORY: MA	
TESLA MOTORS, INC.		
MAKE MODEL		
MM/YY	SEATS: 5	
VIN: XXXXXXXXXXXXXXXXX		
THIS VEHICLE WAS MANUFACTURED TO COMPLY WITH THE MOTOR VEHICLE STANDARDS ACT 1989.		

- ⚠ CAUTION:** To prevent damage, never load Model S so that it is heavier than GVWR or exceeds the individual GAWR weights.

Calculating Load Limits

1. Locate the statement "The combined weight of occupants and cargo should never exceed XXX kg" on the "Tire and Loading Information" label.
2. Determine the combined weight of all occupants that will ride in the vehicle.
3. Subtract the combined weight of the occupants from XXX kg (see Step 1).
4. The resulting figure equals the available cargo load capacity. For example, if the "XXX" amount equals 635 kg and there will be five 68 kg passengers in the vehicle, the amount of available cargo capacity is 295 kg (635 - 340 (5 x 68) = 295 kg).
5. Determine the combined cargo weight being loaded on the vehicle. That weight must not exceed the available cargo load capacity calculated in Step 4.



Vehicle Loading

WARNING: Trunks are the preferred places to carry objects. In a collision, or during hard braking and sharp turns, loose items in the cabin could injure occupants.

Example Load Limit Calculations

How much cargo Model S can carry depends on the number and weight of passengers. The following calculated load limit examples assume passengers weigh 68 kg. If passengers weigh more or less, available cargo weight decreases or increases respectively.

Driver and one passenger

Description	Total
Vehicle capacity weight	433 kg
Subtract occupant weight (2 x 68 kg)	136 kg
Available cargo weight	297 kg

Driver and four passengers

Description	Total
Vehicle capacity weight	433 kg
Subtract occupant weight (5 x 68 kg)	340 kg
Available cargo weight	93 kg

The cargo weight should be distributed between the front and rear trunks.

- CAUTION:** Do not exceed the maximum front trunk load weight of 136 kg.
- CAUTION:** Never load more than 80 kg on the rear load floor (above the lower trunk compartment) or more than 130 kg in the lower trunk compartment. Doing so can cause damage.

Towing a Trailer

- WARNING:** Do not use Model S for towing purposes. Model S does not support a trailer hitch. Installing one could cause damage and increase the risk of a collision.
- CAUTION:** Using Model S for towing may void the warranty.

Roof Racks

If Model S is equipped with a sunroof or a panoramic roof, you can carry up to 165 lbs (75 kg) using a Tesla-approved roof rack (see [Parts and Accessories on page 175](#)). A Model S equipped with a solid body color roof is incompatible with roof racks.

- CAUTION:** Do not use roof racks, or place any load, on the roof of a Model S that is equipped with a solid roof. Doing so can cause significant damage.



Exterior Dimensions

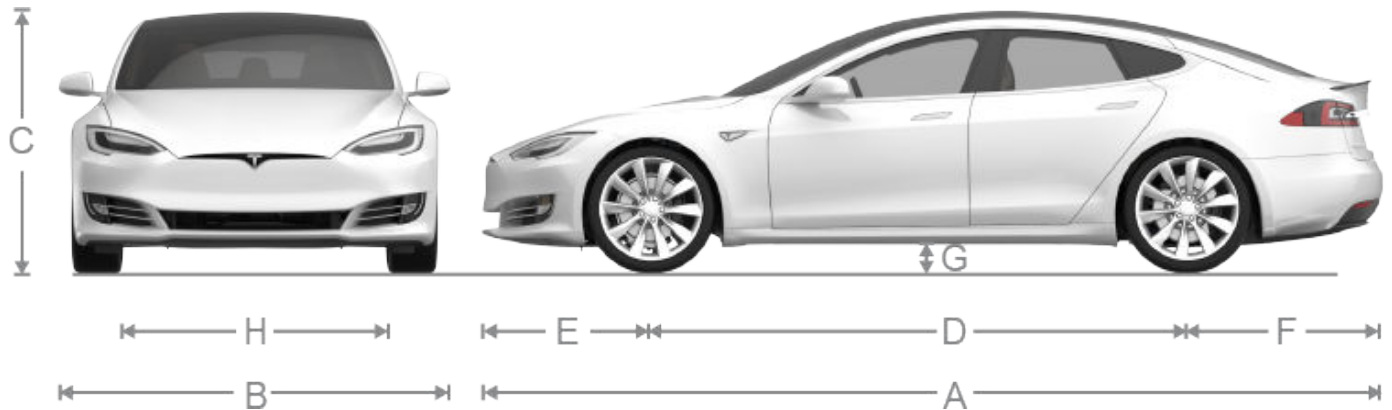

A	Overall Length	196 in	4,970 mm
B	Overall Width (including mirrors)	86.2 in	2,189 mm
	Overall Width (excluding mirrors)	77.3 in	1,964 mm
C	Overall Height	56.9 in*	1,445 mm*
D	Wheel Base	116.5 in	2,960 mm
E	Overhang - Front	36.9 in	929 mm
F	Overhang - Rear	42.55 in	1,081 mm
G	Ground Clearance - Coil Suspension (Rear Wheel Drive vehicle)	5.5 in*	139.7 mm*
G	Ground Clearance - Coil Suspension (All-Wheel Drive vehicle)	5.3 in*	134.6 mm*
G	Ground Clearance - Air Suspension	4.6 - 6.3 in	116.8 - 160 mm
H	Track - Front	65.4 in	1,662 mm
	Track - Rear	66.9 in	1,700 mm

*Values are approximate. Dimensions can vary depending on a vehicle's options and various other factors.

Interior Dimensions

Head Room	Front	38.8 in	986 mm
	Rear	35.3 in	897 mm
Leg Room	Front	42.7 in	1,085 mm
	Rear	35.4 in	899 mm
Shoulder Room	Front	57.7 in	1,466 mm
	Rear	55 in	1,397 mm
Hip Room	Front	55 in	1,397 mm
	Rear	54.7 in	1,389 mm



Dimensions and Weights

Cargo Volume

Total cargo volume (rear seats not folded)	28.4 cu ft	804.2 L
Rear cargo volume	26.3 cu ft	744.7 L
Rear cargo volume (with seats folded down)	58.1 cu ft	1,645.2 L
Front cargo volume	2.1 cu ft	59.5 L

Weights

	Long Range	Performance
Mass in running order (includes driver) (kg)	Total: 2255 Front: 1176 Rear: 1079	Total: 2307 Front: 1167 Rear: 1140
Maximum mass of optional equipment (kg)	Total: 19 Front: 9.5 Rear: 9.5	Total: 19 Front: 9.5 Rear: 9.5
TPMLM* (kg)	Total: 2574 Front: 1270 Rear: 1304	Total: 2626 Front: 1261 Rear: 1365
TPMAM** (kg)	Front: 1300 Rear: 1450	Front: 1300 Rear: 1450
Towing Capacity	Towing is not permissible	

*TPMLM = Technically permissible maximum laden mass

**TPMAM = Technically permissible maximum mass on the axle

NOTE: Values are approximate. Weights can vary depending on a vehicle's options.

Motor Type

Front Motor	AC permanent magnet synchronous motor, liquid-cooled, with variable frequency drive
Rear Motor	AC induction motor, liquid-cooled, with variable frequency drive
Nominal Voltage	320 volts

Maximum Motor Power

	Rated Max Power*	
Standard Range	Front Rear	205 kW 210 kW
Long Range	Front Rear	205 kW 210 kW
Performance	Front Rear	205 kW 375 kW

*Tested in accordance with ECE R85.

Maximum Motor Torque

	Nm	
Standard Range	Front Rear	420 335
Long Range	Front Rear	420 335
Performance	Front Rear	420 720

Transmission

Type	Single speed fixed gear
Overall Final Drive Ratio	Small motor: 9.325:1 Large motor: 9.734:1
Reverse Gear	Reverse direction of motor, limited to 24 km/h

Steering

Type	Rack and pinion with electronic power steering, speed sensitive
Number of turns lock to lock	2.05
Turning Circle (curb to curb)	11.8 meters

Brakes

Type	4-wheel anti-lock braking system (ABS) with Electronic Brake Force Distribution, Integrated Advanced Stability Control and Electronic Accelerator pedal actuated regenerative braking system
Calipers	Front: Four piston, fixed Rear: Single piston, floating
Rotor Diameters (ventilated)	Front: 13.98"/355 mm Rear: 14.37"/365 mm
Front Rotor thickness	New: 1.26"/32 mm Service limit: 1.18"/30 mm
Rear Rotor thickness	New: 1.10"/28 mm Service limit: 1.02"/26 mm
Front Brake Pad Thickness (excluding back plate)	0.346"/8.8 mm
Rear Brake Pad Thickness (excluding back plate)	0.354"/9 mm
Parking brake	Electrically actuated parking brake calipers

Suspension

Front	Independent, double wishbone, air spring or coil spring/telescopic damper, sway bar
Rear	Independent, multi-link, air spring or coil spring/telescopic damper, sway bar (air suspension vehicles only)

Battery - 12V

Rating	33 amp hour or higher
Voltage and Polarity	12V negative (-) ground

Battery - High Voltage

Type	Liquid-cooled lithium ion (Li-ion)
Nominal Voltage	350 V DC

Temperature Range	Do not expose Model S to ambient temperatures above 60° C or below -30° C for more than 24 hours at a time.
-------------------	---



Wheel Specifications (Factory)

Wheel Type	Location	Size	Offset	
19"	Front	8.0J x 19	1.575" 40 mm	
	Rear	8.0J x 19	1.575" 40 mm	
19"	Front	8.5J x 19	1.378" 35 mm	
	21" - Silver (standard)	Front	8.5J x 21	1.575" 40 mm
21" - Grey (standard)	Rear	8.5J x 21	1.575" 40 mm	
21" - Silver and Grey (optional) Performance Plus vehicles	Rear	9.0J x 21	1.575" 40 mm	
Lug Nut Torque	129 lb. ft (175 Nm)			
Lug Nut Socket Size	21 mm			
NOTE: For instructions on how to jack/lift Model S, see Jacking and Lifting on page 174 .				

Tire Specifications (Factory)

Tire Type	Location	Size
19" wheels	All	P245/45R19
21" wheels	Front	P245/35R21
	Rear	P265/35R21*
*On a Performance All-Wheel Drive vehicle, the width of the rear tires may vary depending on date of manufacture. Some vehicles may be equipped with P245/35R21 tires on both front and rear.		
Tire pressures vary depending on the type of tires fitted. Refer to the tire pressures printed on the Tire and Loading Information label. This label is located on the center door pillar and is visible when the driver's door is open (see Maintaining Tire Pressures on page 162).		



Tire Type	Location	Size
Winter tires can be purchased from a Tesla service center or may be available for purchase on the Tesla web site.		



Understanding Tire Markings

Laws require tire manufacturers to place standardized information on the sidewall of all tires. This information identifies and describes the fundamental characteristics of the tire.



1	Tire category. P indicates that the tire is for passenger vehicles.
2	Tire width. This 3-digit number is the width (in millimeters) of the tire from sidewall edge to sidewall edge.
3	Aspect ratio. This 2-digit number is the sidewall height as a percentage of the tread width. So, if the tread width is 205 mm, and the aspect ratio is 50, the sidewall height is 102 mm.
4	Tire construction. R indicates that the tire is of Radial ply construction.
5	Wheel diameter. This 2-digit number is the diameter of the wheel rim in inches.
6	Load index. This 2 or 3-digit number is the weight each tire can support. This number is not always shown.



7	Speed rating. When stated, indicates the maximum speed (in mph) at which the tire can be used for extended periods. Q=99 mph (160 km/h), R=106 mph (170 km/h), S=112 mph (180 km/h), T=118 mph (190 km/h), U=124 mph (200 km/h), H=130 mph (210 km/h), V=149 mph (240 km/h), W=168 mph (270 km/h), Y=186 mph (300 km/h).
8	Tire composition and materials. The number of plies in both the tread area and the sidewall area indicates how many layers of rubber coated material make up the structure of the tire. Information is also provided on the type of materials used.
9	Maximum tire load. The maximum load which can be carried by the tire.
10	Maximum permissible inflation pressure. This pressure should not be used for normal driving.
11	U.S. DOT Tire Identification Number (TIN). Begins with the letters DOT and indicates that the tire meets all federal standards. The next 2 digits/letters represent the plant code where it was manufactured, and the last 4 digits represent the week and year of manufacture. For example, the number 1712 is used to represent the 17th week of 2012. The other numbers are marketing codes used at the manufacturer's discretion. This information can be used to contact consumers if a tire defect requires a recall.
12	Treadwear grade. This number indicates the tire's wear rate. The higher the treadwear number is, the longer it should take for the tread to wear down. A tire rated at 400, for example, lasts twice as long as a tire rated at 200.
13	Traction grade. Indicates a tire's ability to stop on wet roads. A higher graded tire should allow you to stop your vehicle in a shorter distance than a tire with a lower grade. Traction is graded from highest to lowest as AA, A, B, and C.
14	Temperature grade. The tire's resistance to heat is grade A, B, or C, with A indicating the greatest resistance. This grading is provided for a correctly inflated tire, which is being used within its speed and loading limits.



Contacting Tesla Roadside Assistance

Tesla Roadside Assistance is available to you 24 hours a day, 365 days a year, for the duration of your warranty period. Tesla Roadside Assistance is also available to speak with roadside service professionals to answer any questions and explain the proper procedure for transporting your vehicle.

When contacting Tesla Roadside Assistance, please provide:

- The Vehicle Identification Number (VIN). The VIN is displayed when you touch the Tesla "T" at the top of the touchscreen. The VIN can also be seen on the upper dashboard by looking through the driver's side of the windshield.
- Your exact location.
- The nature of the problem.

If available in your region, you can also expedite your request, by choosing the Roadside Assistance option in the Tesla mobile app.

NOTE: For a detailed description of Tesla's Roadside Assistance policy, go to the support page on the Tesla web site for your region.

Regional Phone Number(s)

Australia: [1800-64-6952](tel:1800-64-6952)

NOTE: The phone number is also available by touching the Tesla "T" at the top center of the touchscreen.



DO NOT TRANSPORT WITH WHEELS ON THE GROUND

The front motor in Model S generates power when the wheels spin. Always transport Model S with all four tires off the ground. Ensure that the tires are unable to spin at any time during transport.

⚠ WARNING: NEVER TRANSPORT YOUR VEHICLE WITH THE TIRES IN A POSITION WHERE THEY CAN SPIN. DOING SO CAN LEAD TO SIGNIFICANT DAMAGE AND OVERHEATING. IN RARE CASES EXTREME OVERHEATING MAY CAUSE THE SURROUNDING COMPONENTS TO IGNITE.



Do not transport Model S using any method that is not specified by Tesla. Adhere to the instructions provided in the following sections and observe all warnings and cautions provided. Damage caused by improper transporting of your vehicle is not covered by the warranty.

NOTE: Tesla is not liable or responsible for reimbursing services not dispatched through Tesla Roadside Assistance.

Approved Methods for Transporting

NOTE: The tires are allowed to rotate slowly (under 5 km/h) and for a very short distance (less than 10 meters) only when Transport Mode is enabled (see [Activate Transport Mode on page 190](#)) while the vehicle is being winched onto a flatbed truck or pulled out of a parking space for repositioning. Exceeding these boundaries can lead to significant damage and overheating that is not covered by the warranty.

A flatbed truck or comparable transport vehicle is the recommended method of transporting Model S. The vehicle can face either direction when using a flatbed.



If Model S must be transported without a flatbed truck, then wheel lifts and dollies must be used to ensure that all four wheels are off the ground. This method may only be used for a maximum of 55 km, and must not exceed the manufacturer speed rating of the dollies. With this method, Tesla recommends the vehicle facing forward so that the front wheels are lifted and the rear wheels are on dollies.

NOTE: Transporting Model S with the front wheels on dollies is not recommended, but may be done if an external steering wheel lock is applied and care is taken to prevent the front wheels from spinning. **DO NOT TRANSPORT YOUR VEHICLE IF THERE IS ANY CHANCE OF THE FRONT WHEELS SPINNING.**



⚠ CAUTION: Enable Transport Mode (see [Activate Transport Mode on page 190](#)) before winching Model S onto a flatbed truck (see [Pull onto the Flatbed Truck - With Tow Eye on page 190](#)). If Transport Mode is not available or the touchscreen is not accessible, self-loading dollies or tire skates must be used to load the vehicle into the approved transportation position. Tesla is not responsible for any damage caused by or during the transport of Model S, including personal property damage or damage caused by using self-loading dollies or tire skates.

⚠ WARNING: Model S is equipped with high voltage components that may be compromised as a result of a collision (see [High Voltage Components on page 152](#)). Before transporting Model S, it is important to assume these components are energized. Always follow high voltage safety precautions (wearing personal protection equipment, etc.) until emergency response professionals have evaluated the vehicle and can accurately confirm that all high voltage systems are no longer energized. Failure to do so may result in serious injury.

Disable the Self-Leveling Air Suspension System

If Model S is equipped with the air suspension system, it automatically self-levels, even when power is off. To prevent damage, you must activate Jack Mode to disable self-leveling:



Instructions for Transporters

1. Touch **Controls** > **Suspension** on the touchscreen.
2. Press the brake pedal, then touch **Very High** to maximize height.
3. Touch **Controls** > **Service** > **Jack Mode**.

	When Jack Mode is active, Model S displays this red indicator light on the instrument panel, along with a message telling you that active suspension is disabled.
--	---

NOTE: Jack Mode cancels when driving speed exceeds 7 kph.

WARNING: Failure to activate Jack Mode on a vehicle equipped with the air suspension system can result in the vehicle becoming loose during transport, which may cause significant damage.

Activate Transport Mode

Transport Mode keeps the parking brake disengaged while winching Model S onto a flatbed truck. When active, Transport Mode displays a message indicating that the vehicle will remain free-rolling. The following are required to enable Transport Mode:

- 12V power is required. You are unable to use the touchscreen to activate Transport Mode if Model S has no power.
- Model S must detect a key. Transport Mode is available only when a key is detected.

To activate Transport Mode:

1. Ensure the vehicle is in Park.
2. Chock the tires or otherwise ensure Model S is secure.
3. Press and hold the brake pedal, then on the touchscreen, touch **Controls** > **Service** > **Towing**. The touchscreen displays a message reminding you how to properly transport Model S.
4. Press and hold the **Transport Mode** button until it turns blue. Model S is now free-rolling and can slowly be rolled (no faster than walking speed) or winched.

To cancel Transport Mode, shift Model S into Park.

NOTE: If Model S loses 12V power after Transport Mode is enabled, Transport Mode cancels.

CAUTION: If the electrical system is not working, and you therefore cannot use the touchscreen to activate Transport Mode, use self-loading dollies or tire skates. Before doing so, always check the manufacturer's specifications and recommended loading capacity.

Pull onto the Flatbed Truck - With Tow Eye

1. Locate the tow eye.
2. Remove the tow eye cover by inserting a small flat screwdriver into the slot located along the top of the cover, then prying gently to release the cover from the top snap.



NOTE: Keep the tow eye cover in a safe place so you can replace it when towing is complete.

3. Fully insert the tow eye into the opening, then turn it counter-clockwise until securely fastened.



4. Attach the winch cable to the tow eye.



⚠ CAUTION: Before pulling, make sure the tow eye is securely fastened.

5. Activate Transport Mode by touching **Controls > Service > Towing**.
6. Pull Model S slowly onto the flatbed truck.

Pull onto the Flatbed Truck - Without Tow Eye

It is strongly recommended that you connect the winch to your vehicle's tow eye, as described previously. However, if a situation arises in which the tow eye is not available (lost, misplaced, etc.), the following instructions describe how to attach tow straps.

1. Attach the tow straps to each of the lower suspension arms underneath the front of the vehicle.



2. To protect the underbody from damage, place a protective barrier (such as a piece of wood) between the tow strap and underbody.
3. Activate Transport Mode by touching **Controls > Service > Towing**.
4. Pull Model S slowly onto the flatbed truck.

Secure the Tires

The vehicle's tires must be secured onto the truck using the eight-point tie-down method.

- Ensure any metal parts on the tie-down straps do not contact painted surfaces or the face of the wheels.
- Do not place tie-down straps over body panels or through the wheels.

⚠ CAUTION: Attaching the tie-down straps to the chassis, suspension or other parts of the vehicle's body may cause damage.





Easter Eggs

But wait, there's more! Below is a list of the Easter Eggs that have been discovered so far and how to access them. To access all discovered Easter Eggs, touch the Toybox icon in the application launcher (see [Touchscreen Overview on page 5](#)).

For This...	Do This...
Arcade	Feeling nostalgic? While in Park, access games from the app launcher or your Easter Egg tray then select a game from the menu to play. Note that, depending on the game, you may need to use your steering wheel buttons or a USB controller to play. NOTE: Depending on vehicle configuration or market region, Entertainment, Arcade, and/or Theater may not be available on your vehicle.
Santa Mode	"What have you been longing for?" Enjoy the holidays year-round with this one! Simply initiate a voice command and say "Ho Ho Ho". Or, if you are feeling extra sour, you can say "Ho Ho Ho Not Funny" instead.
Rainbow Road	Need more cowbell? Visit Rainbow Road by pulling the Autopilot stalk toward you four times in quick succession while Autosteer is enabled.
Sketchpad	Triple-tap the Tesla "T" (top center of the touchscreen) and channel your inner Picasso. Show us what you got! Touch Publish to submit your artistic compositions to Tesla for critiquing.
Mars	Press and hold the Tesla "T" (top center of the touchscreen) then enter mars in the access code popup. The map shows your Model S as a rover on the Martian landscape, and the About Your Tesla box displays SpaceX's interplanetary spaceship.
007 (air suspension vehicles only)	Press and hold the Tesla "T" (top center of the touchscreen) and enter 007 in the access code popup. You are no longer a "Driver", you're a "Diver"! Touch Controls > Suspension to change your depth.
Ludicrous Speed (P100D vehicles only)	Press and hold the Ludicrous setting (Controls > Driving > Acceleration > Ludicrous) for approximately five seconds. Touch Yes, bring it on! if you want to go fast. To display power and acceleration readings on the instrument panel, press either scroll button briefly until the available options are displayed. Then, roll the scroll button to highlight Readout then press the scroll button again.
The Answer to the Ultimate Question of Life, The Universe, and Everything	Rename your car to 42 (see Naming Your Vehicle on page 122) and notice the new name of your Model S.
Rainbow Charge Port	When Model S is locked and charging, press the button on the mobile connector ten times in quick succession. Neat, huh?
Romance Mode	You can't roast chestnuts by an open fire in your car, but you can still cozy up with your loved ones by this virtual fireplace. While in Park, access Romance Mode from your Easter Egg tray. Queue the music and get your romance on!
Emissions Testing Mode	Holiday fun can come in surprising ways. Access Emissions Testing Mode from your Easter Egg tray, then select your preferred fart style and a target seat. Activate by pressing the left scroll wheel button when you're ready to "release" your prank.
TRAX	It's never too late to follow your dream of becoming a world-famous DJ. With TRAX, you can turn your vehicle into your own personal music studio. While in Park, choose from an array of instruments and unique sounds to create the next hit song. Access TRAX through your Easter Egg tray on the touchscreen and get jamming. Microphone and headset not included (depending on vehicle configuration and market region, this may not be available on your vehicle).



Document Applicability

Owner information is updated regularly to reflect updates to your vehicle. However, in some cases, recently released features may not be described. To display information about recently released features, view the Release Notes on the touchscreen. Release Notes are displayed on the touchscreen after a software update, and can be displayed at any time by touching the Tesla "T" at the top of the touchscreen, then touching the Release Notes link. Release notes can also be accessed by navigating to **Controls > Software**. If information related to how to use the touchscreen conflicts with information in the Release Notes, the Release Notes take precedence.

Illustrations

Illustrations are provided for demonstration purposes only. Depending on vehicle options, software version, region of purchase, and specific settings, your vehicle may appear slightly different. Although the owner information is applicable to both right-hand drive and left-hand drive vehicles, many illustrations show only left-hand drive vehicles. However, the essential information that the illustrations are providing is correct.

Feature Availability

Some features are available only on some vehicle configurations and/or only in specific market regions. Options or features mentioned in the owner information does not guarantee they are available on your specific vehicle.

Errors or Inaccuracies

All specifications and descriptions are known to be accurate at time of publishing. However, because continuous improvement is a goal at Tesla, we reserve the right to make product modifications at any time. To communicate any inaccuracies or omissions, or to provide general feedback or suggestions regarding the quality of this owner information, send an email to OwnersManualFeedback@Tesla.com.

Location of Components

Owner information may specify the location of a component as being on the left or right side of the vehicle. As shown, left (1) and right (2) represent the side of the vehicle when sitting inside.

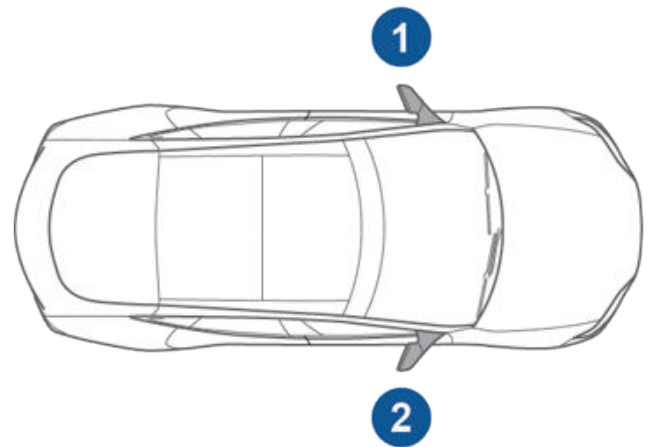

Copyrights and Trademarks

© 2013-2020 Tesla, Inc. All information in this document and all vehicle software is subject to copyright and other intellectual property rights of Tesla, Inc. and its licensors. This material may not be modified, reproduced or copied, in whole or in part, without the prior written permission of Tesla, Inc. and its licensors. Additional information is available upon request. Tesla uses software created by the Open Source community. Please visit Tesla's Open Source software website at www.tesla.com/opensource. HD Radio is a registered trademark of iBiquity Digital Corporation. The following are trademarks or registered trademarks of Tesla, Inc. in the United States and other countries:

TESLA

TESLA MOTORS

TESLA ROADSTER

MODEL S

MODEL X

MODEL 3

MODEL Y

T E S L A



All other trademarks contained in this document are the property of their respective owners and their use herein does not imply sponsorship or endorsement of their products or services. The unauthorized use of any trademark displayed in this document or on the vehicle is strictly prohibited.



Vehicle Telematics

Model S is equipped with electronic modules that monitor and record data from various vehicle systems, including the motor, Autopilot components, Battery, braking and electrical systems. The electronic modules record information about various driving and vehicle conditions, including braking, acceleration, trip and other related information regarding your vehicle. These modules also record information about the vehicle's features such as charging events and status, the enabling/disabling of various systems, diagnostic trouble codes, VIN, speed, direction and location.

The data is stored by the vehicle and may be accessed, used and stored by Tesla service technicians during vehicle servicing or periodically transmitted to Tesla wirelessly through the vehicle's telematics system. This data may be used by Tesla for various purposes, including, but not limited to: providing you with Tesla telematics services; troubleshooting; evaluation of your vehicle's quality, functionality and performance; analysis and research by Tesla and its partners for the improvement and design of our vehicles and systems; to defend Tesla; and as otherwise may be required by law. In servicing your vehicle, Tesla can potentially resolve issues remotely simply by reviewing your vehicle's data log.

Tesla's telematics system wirelessly transmits vehicle information to Tesla on a periodic basis. The data is used as previously described and helps ensure the proper maintenance of your vehicle. Additional Model S features may use your vehicle's telematics system and the information provided, including features such as charging reminders, software updates, and remote access to, and control of, various systems of your vehicle.

Tesla does not disclose the data recorded in your vehicle to any third party except when:

- An agreement or consent from the vehicle's owner (or the leasing company for a leased vehicle) is obtained.
- Officially requested by the police or other authorities.
- Used as a defense for Tesla.
- Ordered by a court of law.
- Used for research purposes without disclosing details of the vehicle owner or identification information.
- Disclosed to a Tesla affiliated company, including their successors or assigns, or our information systems and data management providers.

For additional information regarding how Tesla processes data collected from your vehicle, please review Tesla's Privacy Notice at <http://www.tesla.com/about/legal>.

Data Sharing

For quality assurance and to support the continuous improvement of advanced features such as Autopilot, your Model S may collect analytics, road segment, diagnostic, and vehicle usage data and send to Tesla for analysis. This analysis helps Tesla improve products and services by learning from the experience of billions of miles that Tesla vehicles have driven. Although Tesla shares this data with partners that contribute similar data, the collected information does not identify you personally and can be sent to Tesla only with your explicit consent. In order to protect your privacy, personal information is either not logged at all, is subject to privacy preserving techniques, or is removed from any reports before being sent to Tesla. You have control over what data you share by touching **Controls > Safety & Security > Data Sharing**.

For additional information regarding how Tesla processes data collected from your vehicle, please review Tesla's Privacy Notice at <http://www.tesla.com/about/legal>.

NOTE: Although Model S uses GPS in connection with driving and operation, as discussed in this owner's manual, Tesla does not record or store vehicle-specific GPS information, except the location where a crash occurred. Consequently, Tesla is unable to provide historical information about a vehicle's location (for example, Tesla is unable to tell you where Model S was parked/traveling at a particular date/time).

Quality Control

You might notice a few km on the odometer when you take delivery of your Model S. This is a result of a comprehensive testing process that ensures the quality of your Model S.

The testing process includes extensive inspections during and after production. The final inspection takes place at Tesla and includes a road test conducted by a technician.



Contacting Tesla

For detailed information about your Model S, go to www.tesla.com, and log on to your Tesla Account, or sign up to get an account.

If you have any questions or concerns about your Model S, call Tesla. To find the number for your region, go to www.tesla.com, then view contact information.

NOTE: You can also use voice commands to provide feedback to Tesla. Say "Note", "Report", "Bug note", or "Bug report" (in the English language) followed by brief comments in your language of choice. Model S takes a snapshot of its systems, including your current location, vehicle diagnostic data, and screen captures of the touchscreen and instrument panel. Tesla periodically reviews these notes and uses them to continue improving Model S.



Declarations of Conformity

Key and Passive Unlocking System

FCC Certification

Model Number	Mfr	Frequency	Tested For
A-0749G02	Pektron	315 MHz	USA Canada Mexico Taiwan
A-0749G12	Pektron	315 MHz	USA Canada Mexico Taiwan
WC1	Tesla	127.7 KHz	Global

The devices listed above comply with Part 15 of the FCC rules, Industry Canada's license-exempt RSS Standard(s) and EU Directive 2014/53/EU.

1. This device may not cause harmful interference, and
2. This device must accept any interference received, including interference that may cause undesired operation.

Changes or modifications not expressly approved by Tesla could void your authority to operate the equipment.

Radiation Exposure Statement

The product complies with the FCC/IC RF Exposure for Low Power Consumer Wireless Power Transfer. The RF exposure limit set forth for an uncontrolled environment and are safe for intended operation as described in this manual. The furthest RF exposure that compliance was demonstrated at 20cm and greater separation from the user body or set the device to lower output power if such function is available.

MIC Certification

Model Number	Mfr	MHz	Tested For
A-0749G04/A-0749G14	Pektron	315	Japan

CE Certification

Model #	Mfr	MHz	Tested For
A-0749G01 and A-0749G11	Pektron	433	Europe Australia New Zealand Singapore South Korea
A-0749G05 and A-0749G15	Pektron	433	China



Model #	Mfr	MHz	Tested For
			Hong Kong
			Korea

The devices listed above comply with CE standards.
Operation is subject to the following two conditions:

1. This device may not cause harmful interference, and
2. This device must accept any interference received, including interference that may cause undesired operation.

Changes or modifications not expressly approved by Tesla could void your authority to operate the equipment.

Device Approval - Australia



Media Control Unit

Device Approval - Australia



Tire Pressure Monitoring System

FCC IDs: TZSTPMS201, Z9F-201FS43X

IC ID: 11852A-201FS4X

The tire pressure monitoring system (TPMS) complies with Part 15 of the FCC rules and RSS-210 of Innovation, Science and Economic Development Canada. Operation is subject to the following two conditions:

1. This device may not cause harmful interference, and
2. This device must accept any interference received, including interference that may cause undesired operation.

Changes or modifications not expressly approved by Tesla could void your authority to operate the equipment.



HomeLink

This device complies with Part 15 of the FCC rules, RSS-210 Industry Canada, and with EU Directive 2014/53/EU.

Operation is subject to the following conditions:

- This device may not cause harmful interference.
- This device must accept any interference received, including interference that may cause undesired operation.

Any changes or modifications to the device not expressly approved by the manufacturer or Tesla could void your authority to operate the equipment.

Radio Frequency Information

This equipment has been tested and found to comply with the limits for a Class B digital device, pursuant to Part 15 of the FCC Rules. These limits are designed to provide reasonable protection against harmful interference in a residential installation. This equipment generates, uses and can radiate radio frequency energy and, if not installed and used in accordance with the instructions, may cause harmful interference to radio communications. However, there is no guarantee that interference will not occur in a particular installation. If this equipment does cause harmful interference to radio or television reception, which can be determined by turning the equipment off and on, try to correct the interference by one or more of the following measures:

- Reorient or relocate the receiving antenna.
- Increase the separation between the equipment and receiver.
- Connect the equipment into an outlet on a circuit different from that to which the receiver is connected.
- Consult the dealer or an experienced radio/TV technician for help.



RF Modules

The devices described above comply with CE standards. Operation is subject to the following two conditions:

1. This device may not cause harmful interference, and
2. This device must accept any interference received, including interference that may cause undesired operation.

Changes or modifications not expressly approved by Tesla could void your authority to operate the equipment.

Description	Frequency Band	Power Level	Antenna Location
Keyfob	Transmit - 433.9 MHz Receive - 134.2 kHz	10 mW (0.285µW ERP) @433.9 MHz	n/a
Body/Security Controller	Transmit - 134.2 kHz Receive - 433.9 MHz	n/a (magnetic field)	Front passenger footwell
TPMS Sensor	433.9 MHz	2.5 mW	Each wheel
TPMS Module/Antenna	Receive - 433.9 MHz	n/a (Receive only)	Left side C-pillar
AM/FM	522-1620 kHz 88-108 MHz	n/a (Receive only)	Rear Window
DAB	174-241 MHz	n/a (Receive only)	Rear Window
Homelink	433.9 MHz	10 mW	Above front bumper beam
Passive Entry	Transmit - 134.2 kHz Receive - 433.9 MHz	n/a	2 in instrument panel end caps 1 in rear bumper
Bluetooth	2402-2480 MHz	2.5 mW max.	B-header in the middle ceiling
GSM (band 5/8)	Transmit - 824-849, 880-915 MHz Receive - 864-894, 925-960 MHz	2 W	Transmit - Right side mirror Receive - Right side mirror
GSM (band 2/3)	Transmit - 1710-1785, 1850-1910 MHz Receive - 1805-1880, 1930-1990 MHz	1 W	Transmit - Right side mirror Receive - Right side mirror
WCDMA (Band 5/6/19/8)	Transmit - 824-849, 880-915 MHz Receive - 864-894, 925-960 MHz	250 mW	Transmit - Right side mirror Receive - Right side mirror



Declarations of Conformity

Description	Frequency Band	Power Level	Antenna Location
WCDMA (Band 1/2/3/4)	Transmit - 1710-1785, 1850-1910, 1920-1980 MHz Receive - 1805-1880, 1930-1990, 2110-2170 MHz	250 mW	Transmit - Right side mirror Receive - Right side mirror
LTE (band 5/19/26/8/20/28)	Transmit - 703-748, 814-849, 832-862, 880-915 MHz Receive - 758-803, 791-821, 859-894, 925-960 MHz	200 mW	Transmit - Right side mirror Receive - Right side mirror
LTE (band 21/32)	Transmit - 1447.9-1462.9 MHz Receive - 1452-1510.9 MHz	200 mW	Transmit - Right side mirror Receive - Right side mirror
LTE (band 1/2/3/4)	Transmit - 1710-1785, 1850-1910, 1920-1980 MHz Receive - 1805-1880, 1930-1990, 2110-2170 MHz	200 mW	Transmit - Right side mirror Receive - Right side mirror
LTE (band 7)	Transmit - 2500-2570 MHz Receive - 2620-2690 MHz	200 mW	Transmit - Right side mirror Receive - Right side mirror
Wi-Fi	2400-2483.5 MHz 5180-5825 MHz	100 mW	Left side mirror Left side mirror/B-header in the middle ceiling
GPS	1563-1587 MHz	n/a (Receive only)	Between windshield and rear view mirror



(APP_w207) Autosteer temporarily unavailable

Autosteer is currently unavailable. This could be a temporary condition due to external conditions that include:

- Missing or faded lane markers
- Narrow or winding roads
- Poor visibility due to rain, snow, fog, or other weather conditions
- Extremely hot or cold temperatures
- Bright light due to other vehicle headlights, direct sunlight, or other light sources

If the alert is caused by a temporary factor like these, no action or service is typically needed. Continue to your destination. The alert will clear and Autosteer will be available once the condition is no longer present.

Please note that the minimum speed to initiate Autosteer when there is no vehicle detected ahead of you and while driving on a road with visible lane markings is 18 mph (30 km/h), unless certain vehicle and environmental conditions are met. If a vehicle is detected ahead of you:

- You can initiate Autosteer at any speed under 90 mph (150 km/h).
- You can even initiate Autosteer when stationary, provided the other vehicle is at least 5 feet (150 cm) in front of you.

This alert will be present if you have temporarily exceeded 90 mph (150 km/h) with Autosteer active, and Autosteer will not be available for the rest of your current drive.

- **Note:** If this alert becomes active while you are driving in Germany, Autosteer should again be available once your vehicle is traveling below 90 mph (150 km/h).

If Autosteer is not available by the time you reach your destination, and remains unavailable during your next planned drive, the problem might be one of these issues:

- Damage or obstruction caused by mud, ice, snow, or other environmental factors
- Obstruction caused by an object mounted on the vehicle, like a bike rack
- Obstructions caused by adding paint or adhesive products like wraps, stickers, or rubber coatings to your vehicle
- A damaged or misaligned bumper

The solution might be as simple as washing your vehicle. If you do not find any obvious obstructions or you find damage to the vehicle, schedule service at your convenience. Your vehicle is OK to drive in the meantime.

For more information, see [Autosteer on page 87](#).

(APP_w218) Autosteer speed limit exceeded Take control of steering wheel

Autosteer is unavailable because your vehicle has exceeded the maximum speed limit for this driver assistance feature. Autosteer is only available at speeds up to 90 mph (150 km/h).

Take immediate control of the steering wheel and maintain control until you reach your destination. Your vehicle is OK to drive.

In most cases, Autosteer will not be available for the rest of your current drive. To reset it, you will need to bring the vehicle to a complete stop and shift into Park. When you shift into Drive to travel to your next destination, Autosteer should again be available.

However, there is one exception. If this alert becomes active while you are driving in Germany, Autosteer should again be available once your vehicle is traveling below 90 mph (150 km/h).

If Autosteer is not available during your next drive, and remains unavailable throughout subsequent drives, contact Tesla Service at your convenience. Your vehicle is OK to drive in the meantime.

For more information, see [Autosteer on page 87](#).

(APP_w221) Cruise control unavailable Reduced front radar visibility

Traffic-Aware Cruise Control and Autosteer are unavailable because the radar located in the front bumper area of your vehicle has no or low visibility. Continue to your destination. Your vehicle is OK to drive.

Traffic-Aware Cruise Control and Autosteer will remain unavailable as long as the radar lacks adequate visibility. This could be a temporary obstruction caused by factors like snow, ice, dirt, or mud. If the alert is caused by a temporary factor like these, no action might be needed: the condition might clear during your drive.

If the alert persists throughout your drive, examine the front bumper before your next planned drive and attempt to clear any obstruction.



Troubleshooting Alerts

- See the [About Autopilot on page 79](#) sections “How It Works” and “Cleaning Cameras and Sensors” for more on the radar location and care needed if clearing dirt / debris from that area of the vehicle.
- See [Cleaning on page 167](#) for general cleaning tips and cautions.

Once the radar regains adequate visibility, the alert will clear and both Traffic-Aware Cruise Control and Autosteer should again be available.

If this alert persists throughout subsequent drives but no obstruction is visible on the front bumper where the radar is located, contact Tesla Service at your earliest convenience. Your vehicle is OK to drive in the meantime.

(APP_w222) Cruise control unavailable Reduced front camera visibility

Traffic-Aware Cruise Control and Autosteer are unavailable because one or more of the front cameras in your vehicle is blocked or blinded by external conditions. Continue to your destination. Your vehicle is OK to drive.

Traffic-Aware Cruise Control and Autosteer will remain unavailable while a front camera lacks adequate visibility. Cameras can be blocked or blinded due to many factors that include:

- Dirt or debris on the camera surface
- Environmental conditions like rain, fog, snow, or dew
- Bright sunlight or glare from another light source
- Condensation (water droplets or mist) on the camera surface

This is often a temporary issue that will clear up when condensation evaporates or a particular environmental condition is no longer present.

If the alert does not clear by the end of your drive, inspect and clean the front camera area at the top center of the windshield before your next planned drive. Check the camera surface for condensation, dirt, or other debris and attempt to clear any obstruction. See the [About Autopilot on page 79](#) sections “How It Works” and “Cleaning Cameras and Sensors” for more on front camera location and tips for careful cleaning.

Although condensation on the inside of the front camera enclosure cannot be wiped clean, you can usually clear it quicker by following these steps:

1. Pre-condition the cabin with the temperature set to High and A/C turned ON.
2. Turn on the front windshield defroster.

Once all front cameras regain adequate visibility, the alert will clear and both Traffic-Aware Cruise Control and Autosteer should again be available.

If this alert persists throughout subsequent drives but no front camera obstruction is visible, contact Tesla Service at your earliest convenience. Your vehicle is OK to drive in the meantime.

(APP_w224) Cruise control unavailable Continue driving to allow cameras to calibrate

Traffic-Aware Cruise Control and Autosteer are unavailable because the cameras on your vehicle are not fully calibrated. Continue to your destination. Your vehicle is OK to drive.

Traffic-Aware Cruise Control and Autosteer will remain unavailable until camera calibration is complete.

Your vehicle must maneuver with great precision when features like Traffic-Aware Cruise Control and Autosteer are active. Before these features can be used for the first time, the cameras must complete an initial self-calibration. Occasionally, one or more cameras can become uncalibrated.

For your convenience, a calibration progress indicator is displayed on the touchscreen. Calibration typically completes after your vehicle has driven 20-25 miles (32-40 km), but the distance varies depending on road and environmental conditions. For example, driving on a straight road with highly visible lane markings helps the cameras calibrate quicker.

See [Drive to Calibrate Cameras on page 80](#) for more information.

When calibration is complete, Traffic-Aware Cruise Control and Autosteer should be available.

If the alert persists and camera calibration has not completed after your vehicle has driven 100 miles (160 km) or more, or Traffic-Aware Cruise Control and Autosteer remain unavailable despite successful camera calibration, contact Tesla Service at your earliest convenience. Your vehicle is OK to drive in the meantime.

(APP_w304) Camera blocked or blinded Clean camera or wait for it to regain visibility

One or more of the vehicle cameras is blocked or blinded due to external conditions. When the cameras cannot provide accurate visual information, some or all Autopilot features may be temporarily restricted.



Cameras can be blocked or blinded due to many factors that include:

- Dirt or debris on the camera surface
- Environmental conditions like rain, fog, snow, or dew
- Bright sunlight or glare from another light source
- Condensation (water droplets or mist) on the camera surface

Continue to your destination. This is often a temporary issue that will clear up when condensation evaporates or a particular environmental condition is no longer present.

If the alert does not clear by the time you reach your destination, check the camera surface for condensation, dirt, or other debris.

For camera locations, see [About Autopilot on page 79](#).

Clean the camera as necessary before your next planned drive by gently wiping the camera lens with a soft damp cloth.

If you continue to see this alert after cleaning the cameras, check the inside surfaces of the door pillar camera enclosures for condensation.

Although condensation on the inside of the camera enclosures cannot be wiped clean, you can usually clear it quicker by following these tips:

1. Pre-condition the cabin with the temperature set to High and A/C turned ON.
2. Turn on the front windshield defroster.
3. Direct the air vents toward the door pillar cameras.

For more information on cleaning cameras and removing condensation, see [Cleaning Cameras and Sensors on page 81](#).

If the alert does not clear by the end of your next planned drive, despite camera cleaning and following the tips above to remove condensation, schedule service at your convenience. The vehicle is OK to drive in the meantime.

(CC_f001) **Unable to charge – Insufficient grounding** **Check outlet or wiring for proper grounding**

What this alert means:

No ground connection detected in the Wall Connector.

What to do:

Make sure the Wall Connector is properly grounded. If uncertain, consult your electrician to ensure proper grounding at your circuit breaker or power distribution box and that appropriate connections are made to the Wall Connector.

(CC_f002) **Unable to charge – Insufficient grounding** **Disconnect and retry or use different equipment**

What this alert means:

Ground fault. Current is leaking through an unsafe path. Possible Line to ground or Neutral to ground fault.

What to do:

Try again by disconnecting the Wall Connector from the vehicle and reconnecting. If the problem persists, turn OFF the circuit breaker servicing the Wall Connector, wait 10 seconds, turn the circuit breaker ON again, then try reconnecting the Wall Connector to the vehicle. If the problem persists, contact Tesla.

(CC_f003) **Unable to charge – Wall Connector GFCI tripped** **Disconnect and retry or use different equipment**

What this alert means:

Ground fault. Current is leaking through an unsafe path. Possible Line to ground or Neutral to ground fault.

What to do:

Try again by disconnecting the Wall Connector from the vehicle and reconnecting. If the problem persists, turn OFF the circuit breaker servicing the Wall Connector, wait 10 seconds, turn the circuit breaker ON again, then try reconnecting the Wall Connector to the vehicle. If the problem persists, contact Tesla.

(CC_f004) **Unable to charge – Wall Connector issue** **Wall Connector needs service**

What this alert means:

Wall Connector hardware issue. Possible issues include:

1. Contactor not working



2. Self-test of internal ground fault monitoring circuit failed
3. Thermal sensor disconnected
4. Other hardware component issues

What to do:

An internal issue was detected by the Wall Connector.

1. Try charging again by disconnecting the Wall Connector from the vehicle and reconnecting.
2. If the issue persists, turn OFF the circuit breaker for the Wall Connector, wait 10 seconds, and turn the circuit breaker ON again. Then try reconnecting the Wall Connector to the vehicle.
3. If the issue persists, check for loose connections.
 - a. Make sure there is no power to the Wall Connector.
 - b. Remove the face plate and inspect the wiring terminals for any loose connections.
 - c. Contact an electrician if necessary to make sure all wires are properly connected and torqued according to the instructions in the Wall Connector Installation Manual.
4. Once all connections have been checked and made secure, restore power to the Wall Connector and try charging again by reconnecting to the vehicle.
5. If the issue persists, the Wall Connector needs service. Schedule a service appointment through your Mobile App.

(CC_f005) Unable to charge - Wall Connector GFCI tripped Disconnect and retry or use different equipment

What this alert means:

Ground fault. Current is leaking through an unsafe path. Possible Line to ground or Neutral to ground fault.

What to do:

Try again by disconnecting the Wall Connector from the vehicle and reconnecting. If the problem persists, turn OFF the circuit breaker servicing the Wall Connector, wait 10 seconds, turn the circuit breaker ON again, then try reconnecting the Wall Connector to the vehicle. If the problem persists, contact Tesla.

(CC_f006) Unable to charge - Wall Connector overcurrent Disconnect and retry or use different equipment

What this alert means:

Over current protection.

What to do:

Reduce the vehicle's charge current setting. If the problem persists and the attached vehicle is manufactured by Tesla, contact Tesla. If the problem persists and If the attached vehicle is not manufactured by Tesla, contact the original manufacturer.

(CC_f007) Unable to charge - Voltage too high Check voltage is within Wall Connector rating

What this alert means:

Over or under voltage protection.

What to do:

Consult your electrician to ensure appropriate voltage on the circuit breaker that services the Wall Connector.

(CC_f008) Unable to charge - Voltage too low Check voltage is within Wall Connector rating

What this alert means:

Over or under voltage protection.

What to do:

Consult your electrician to ensure appropriate voltage on the circuit breaker that services the Wall Connector.

(CC_f009) Unable to charge - Input wired incorrectly Reconnect Wall Connector wiring correctly

What this alert means:



Input miswired: possibly Line and Neutral are swapped.

What to do:

The wiring between the wall power and the Wall Connector has been incorrectly installed. Consult your electrician.

(CC_f010)
Unable to charge - Wall Connector issue
Wall Connector needs service

What this alert means:

Wall Connector hardware issue. Possible issues include:

1. Contactor not working
2. Self-test of internal ground fault monitoring circuit failed
3. Thermal sensor disconnected
4. Other hardware component issues

What to do:

An internal issue was detected by the Wall Connector.

1. Try charging again by disconnecting the Wall Connector from the vehicle and reconnecting.
2. If the issue persists, turn OFF the circuit breaker for the Wall Connector, wait 10 seconds, and turn the circuit breaker ON again. Then try reconnecting the Wall Connector to the vehicle.
3. If the issue persists, check for loose connections.
 - a. Make sure there is no power to the Wall Connector.
 - b. Remove the face plate and inspect the wiring terminals for any loose connections.
 - c. Contact an electrician if necessary to make sure all wires are properly connected and torqued according to the instructions in the Wall Connector Installation Manual.
4. Once all connections have been checked and made secure, restore power to the Wall Connector and try charging again by reconnecting to the vehicle.
5. If the issue persists, the Wall Connector needs service. Schedule a service appointment through your Mobile App.

(CC_f011)
Unable to charge - Wall Connector too hot
Let Wall Connector cool and try again

What this alert means:

Over temperature protection (latchoff).

What to do:

Make sure the Wall Connector is not covered by anything and that there is no heat source nearby. If the problem persists in normal ambient temperatures (under 38°C), contact Tesla.

(CC_f012)
Unable to charge - Wall connection too hot
Check outlet or Wall Connector wiring

High temperature detected by Wall Connector alerts indicate the building connection to the Wall Connector is getting too warm, so charging has stopped to protect the wiring and Wall Connector.

This is not typically an issue with your vehicle or your Wall Connector, but rather an issue with the building wiring. This may be caused by a loose building wiring connection to the Wall Connector and can be fixed quickly by an electrician.

To regain normal charge operation, try the following steps.

If the Wall Connector is plugged into a wall outlet, make sure:

- The plug is fully inserted into the receptacle / outlet
- The plug / outlet area is not blocked or covered by anything
- There is no heat source nearby

If the issue persists or the Wall Connector is hard-wired, contact an electrician to inspect the building wiring connection to the Wall Connector. They should make sure that all wires are properly connected and torqued according to the installation guide for the Wall Connector.

Wall Connector installation guides can be found [here](#).

(CC_f013)
Unable to charge - Charge handle too hot
Check charge handle or charge port for debris

What this alert means:

Over temperature protection (latchoff).

What to do:

Make sure the connector is fully inserted into the charge inlet in the vehicle's charging port, is not covered by anything, and there is no heat source nearby. If the problem persists in normal ambient temperatures (under 38°C), contact Tesla.

(CC_f014)
Unable to charge - Wall Connector issue
Wall Connector needs service

What this alert means:

Wall Connector hardware issue. Possible issues include:

1. Contactor not working
2. Self-test of internal ground fault monitoring circuit failed
3. Thermal sensor disconnected
4. Other hardware component issues

What to do:

An internal issue was detected by the Wall Connector.

1. Try charging again by disconnecting the Wall Connector from the vehicle and reconnecting.
2. If the issue persists, turn OFF the circuit breaker for the Wall Connector, wait 10 seconds, and turn the circuit breaker ON again. Then try reconnecting the Wall Connector to the vehicle.
3. If the issue persists, check for loose connections.
 - a. Make sure there is no power to the Wall Connector.
 - b. Remove the face plate and inspect the wiring terminals for any loose connections.
 - c. Contact an electrician if necessary to make sure all wires are properly connected and torqued according to the instructions in the Wall Connector Installation Manual.

4. Once all connections have been checked and made secure, restore power to the Wall Connector and try charging again by reconnecting to the vehicle.
5. If the issue persists, the Wall Connector needs service. Schedule a service appointment through your Mobile App.

(CC_f015)
Unable to charge - Vehicle connection issue
Insert charge handle fully into charge port

What this alert means:

A communication error occurred between the Wall Connector and the vehicle.

What to do:

Try again by disconnecting the Wall Connector from the vehicle and reconnecting. If possible, plug the vehicle into another Wall Connector or a Mobile Connector to determine if the vehicle is able to communicate with other charging equipment. If the problem persists, contact Tesla.

(CC_f016)
Unable to charge - Vehicle connection issue
Insert charge handle fully into charge port

What this alert means:

A communication error occurred between the Wall Connector and the vehicle.

What to do:

Try again by disconnecting the Wall Connector from the vehicle and reconnecting. If possible, plug the vehicle into another Wall Connector or a Mobile Connector to determine if the vehicle is able to communicate with other charging equipment. If the problem persists, contact Tesla.

(CC_f017)
Unable to charge - Vehicle connection issue
Insert charge handle fully into charge port

What this alert means:



A communication error occurred between the Wall Connector and the vehicle.

What to do:

Try again by disconnecting the Wall Connector from the vehicle and reconnecting. If possible, plug the vehicle into another Wall Connector or a Mobile Connector to determine if the vehicle is able to communicate with other charging equipment. If the problem persists, contact Tesla.

(CC_f018)

Unable to charge – Vehicle connection issue Insert charge handle fully into charge port

What this alert means:

A communication error occurred between the Wall Connector and the vehicle.

What to do:

Try again by disconnecting the Wall Connector from the vehicle and reconnecting. If possible, plug the vehicle into another Wall Connector or a Mobile Connector to determine if the vehicle is able to communicate with other charging equipment. If the problem persists, contact Tesla.

(CC_f019)

Unable to charge – Vehicle connection issue Insert charge handle fully into charge port

What this alert means:

A communication error occurred between the Wall Connector and the vehicle.

What to do:

Try again by disconnecting the Wall Connector from the vehicle and reconnecting. If possible, plug the vehicle into another Wall Connector or a Mobile Connector to determine if the vehicle is able to communicate with other charging equipment. If the problem persists, contact Tesla.

(CC_f020)

Unable to charge – Wall Connector issue Wall Connector needs service

What this alert means:

Wall Connector hardware issue. Possible issues include:

1. Contactor not working
2. Self-test of internal ground fault monitoring circuit failed
3. Thermal sensor disconnected
4. Other hardware component issues

What to do:

An internal issue was detected by the Wall Connector.

1. Try charging again by disconnecting the Wall Connector from the vehicle and reconnecting.
2. If the issue persists, turn OFF the circuit breaker for the Wall Connector, wait 10 seconds, and turn the circuit breaker ON again. Then try reconnecting the Wall Connector to the vehicle.
3. If the issue persists, check for loose connections.
 - a. Make sure there is no power to the Wall Connector.
 - b. Remove the face plate and inspect the wiring terminals for any loose connections.
 - c. Contact an electrician if necessary to make sure all wires are properly connected and torqued according to the instructions in the Wall Connector Installation Manual.
4. Once all connections have been checked and made secure, restore power to the Wall Connector and try charging again by reconnecting to the vehicle.
5. If the issue persists, the Wall Connector needs service. Schedule a service appointment through your Mobile App.

(CC_f021)

Unable to charge – No Master Wall Connector Check that Master is powered and available

What this alert means:

Circuit Breaker Sharing Network: Need one (and only one) Wall Connector set to Master.

What to do:

Only one Wall Connector can be set to a master configuration. All other linked Wall Connectors must be set to paired (position F). Set one of the Wall Connectors to Master and all others to paired.

(CC_f022) Unable to charge - More than 1 Master Ensure only 1 Wall Connector is set as Master

What this alert means:

Circuit Breaker Sharing Network: Need one (and only one) Wall Connector set to Master.

What to do:

Only one Wall Connector can be set to a master configuration. All other linked Wall Connectors must be set to paired (position F). Set one of the Wall Connectors to Master and all others to paired.

(CC_f023) Unable to charge - Too many Wall Connectors Ensure no more than 3 units paired to Master

What this alert means:

Circuit Breaker Sharing Network: More than three Wall Connectors are paired with the same Master.

What to do:

One or more paired Wall Connectors must be moved to a different circuit and disconnected (unpaired) from this Circuit Breaker Sharing Network.

(CC_f024) Unable to charge - Low Wall Connector current Increase Master current or unpair other units

What this alert means:

Incorrect rotary switch setting.

What to do:

Make sure there is no power to the Wall Connector. Remove the face plate and adjust the rotary switch to a valid operating current setting. The correlation between switch setting and current is printed on the inside of the Wall Connector. You can also refer to the Set the Operating Current section in the Wall Connector Installation Manual. If the Wall Connector is set up for load sharing (paired with other Wall Connectors), the rotary switch of the master unit must be set to an operating current setting that allows each paired Wall Connector to receive at least 6A of charge current. Example: Three Wall Connectors are paired for load sharing. The master unit needs to be set to a current of at least $3 * 6A = 18A$ or greater.

(CC_f025) Unable to charge - Wall Connector issue Wall Connector needs service

What this alert means:

Wall Connector hardware issue. Possible issues include:

1. Contactor not working
2. Self-test of internal ground fault monitoring circuit failed
3. Thermal sensor disconnected
4. Other hardware component issues

What to do:

An internal issue was detected by the Wall Connector.

1. Try charging again by disconnecting the Wall Connector from the vehicle and reconnecting.
2. If the issue persists, turn OFF the circuit breaker for the Wall Connector, wait 10 seconds, and turn the circuit breaker ON again. Then try reconnecting the Wall Connector to the vehicle.
3. If the issue persists, check for loose connections.
 - a. Make sure there is no power to the Wall Connector.
 - b. Remove the face plate and inspect the wiring terminals for any loose connections.
 - c. Contact an electrician if necessary to make sure all wires are properly connected and torqued according to the instructions in the Wall Connector Installation Manual.
4. Once all connections have been checked and made secure, restore power to the Wall Connector and try charging again by reconnecting to the vehicle.
5. If the issue persists, the Wall Connector needs service. Schedule a service appointment through your Mobile App.



(CC_f026)
Unable to charge - Wall Connector issue
Wall Connector needs service

What this alert means:

Wall Connector hardware issue. Possible issues include:

1. Contactor not working
2. Self-test of internal ground fault monitoring circuit failed
3. Thermal sensor disconnected
4. Other hardware component issues

What to do:

An internal issue was detected by the Wall Connector.

1. Try charging again by disconnecting the Wall Connector from the vehicle and reconnecting.
2. If the issue persists, turn OFF the circuit breaker for the Wall Connector, wait 10 seconds, and turn the circuit breaker ON again. Then try reconnecting the Wall Connector to the vehicle.
3. If the issue persists, check for loose connections.
 - a. Make sure there is no power to the Wall Connector.
 - b. Remove the face plate and inspect the wiring terminals for any loose connections.
 - c. Contact an electrician if necessary to make sure all wires are properly connected and torqued according to the instructions in the Wall Connector Installation Manual.
4. Once all connections have been checked and made secure, restore power to the Wall Connector and try charging again by reconnecting to the vehicle.
5. If the issue persists, the Wall Connector needs service. Schedule a service appointment through your Mobile App.

(CC_f027)
Unable to charge - Wall Connector issue
Wall Connector needs service

What this alert means:

Wall Connector hardware issue. Possible issues include:

1. Contactor not working
2. Self-test of internal ground fault monitoring circuit failed

3. Thermal sensor disconnected
4. Other hardware component issues

What to do:

An internal issue was detected by the Wall Connector.

1. Try charging again by disconnecting the Wall Connector from the vehicle and reconnecting.
2. If the issue persists, turn OFF the circuit breaker for the Wall Connector, wait 10 seconds, and turn the circuit breaker ON again. Then try reconnecting the Wall Connector to the vehicle.
3. If the issue persists, check for loose connections.
 - a. Make sure there is no power to the Wall Connector.
 - b. Remove the face plate and inspect the wiring terminals for any loose connections.
 - c. Contact an electrician if necessary to make sure all wires are properly connected and torqued according to the instructions in the Wall Connector Installation Manual.
4. Once all connections have been checked and made secure, restore power to the Wall Connector and try charging again by reconnecting to the vehicle.
5. If the issue persists, the Wall Connector needs service. Schedule a service appointment through your Mobile App.

(CC_f028)
Unable to charge - Incorrect switch setting
Adjust rotary switch setting in Wall Connector

What this alert means:

Incorrect rotary switch setting.

What to do:

Make sure there is no power to the Wall Connector. Remove the face plate and adjust the rotary switch to a valid operating current setting. The correlation between switch setting and current is printed on the inside of the Wall Connector. You can also refer to the Set the Operating Current section in the Wall Connector Installation Manual. If the Wall Connector is set up for load sharing (paired with other Wall Connectors), the rotary switch of the master unit must be set to an operating current setting that allows each paired Wall Connector to receive at least 6A of charge current. Example: Three Wall Connectors are paired for load sharing. The master unit needs to be set to a current of at least $3 * 6A = 18A$ or greater.

(CC_f029) Unable to charge - Vehicle connection issue Insert charge handle fully into charge port

What this alert means:

A communication error occurred between the Wall Connector and the vehicle.

What to do:

Try again by disconnecting the Wall Connector from the vehicle and reconnecting. If possible, plug the vehicle into another Wall Connector or a Mobile Connector to determine if the vehicle is able to communicate with other charging equipment. If the problem persists, contact Tesla.

(CC_f030) Unable to charge - Master / paired mismatch Make Wall Connector current ratings match

What this alert means:

Circuit Breaker Sharing Network: The paired Wall Connectors have different maximum current capabilities.

What to do:

Only Wall Connectors with the same maximum current capabilities can be paired in a load-sharing (circuit breaker sharing) network. Inspect the type labels on the Wall Connectors to make sure the current capabilities match. It is further recommended to only pair Wall Connectors with the same part number, as an easy way to make sure paired units are compatible.

(CC_f041) Charging speed reduced High temperature detected by Wall Connector

High temperature detected by Wall Connector alerts indicate the building connection to the Wall Connector is getting too warm, so charging has been slowed to protect the wiring and Wall Connector.

This is not typically an issue with your vehicle or your Wall Connector, but rather an issue with the building wiring. This may be caused by a loose building wiring connection to the Wall Connector and can be fixed quickly by an electrician.

To regain normal charge speed, contact an electrician to inspect the building wiring connection to the Wall Connector. They should make sure that all wires are properly connected and torqued according to the installation guide for the Wall Connector.

Wall Connector installation guides can be found [here](#).

(CHG_f091) Charging equipment not recognized Try again or try different equipment

The charge port is unable to detect whether a charge cable is inserted or the type of charge cable connected.

If this alert appears while a charge cable **is** connected, it should be determined whether the issue is caused by the charging equipment or the vehicle. Try charging the vehicle using different external charging equipment (charge cable, charging station, charging stall, etc.).

- If the vehicle begins charging, the issue was likely with the equipment.
- If the vehicle still does not charge, the issue may be with the vehicle.

If this alert appears while a charge cable is **not** connected or if the issue is suspected to be with the vehicle, inspect the charge port inlet and the charge cable connector for any obstructions (use a flashlight as necessary). Debris, moisture, and/or foreign objects present in the charge port inlet or the charge cable connector can prevent the charge port from properly detecting charge cables. If any obstruction is found:

1. Remove the debris / foreign object or dry any moisture.
2. Try re-inserting the cable into the charge port. Charging should now be possible.

As this alert is usually specific to external charging equipment and power sources, and it does not typically indicate an issue with your vehicle that can be resolved by scheduling service, it is recommended that you:

- Try charging with multiple, different types of charging equipment.
- Make sure any charge port inlet obstruction has been removed.

You can also try charging your vehicle using a Tesla Supercharger or Destination Charging location, all of which can be located through the map on your vehicle's touchscreen display. See [Range Assurance on page 72](#) for more details. Additional third-party charging stations may also be available in your area to help you to pinpoint the issue.



For more information on troubleshooting Mobile Connector or Wall Connector status lights, refer to the product's Owner's Manual at [Charging & Adapter Product Guides](#). If using other external charging equipment, refer to the manufacturer's provided documentation for troubleshooting tips.

For more information on charging, see [Charging Instructions on page 155](#).

(CHG_u001) Charge rate reduced Check for an extension cord or bad utility wiring

Charging speed has been reduced because the onboard charger in your vehicle has detected a large voltage drop during charging.

Likely causes of this issue include:

- Problems with the building wiring and/or the wall outlet.
- An extension cord or other wiring that cannot support the requested charge current.

This issue can also result from turning on electric devices that draw a lot of power from the same branch circuit while the vehicle is charging.

If this issue has occurred multiple times at your normal charging location, contact an electrician to inspect the electrical installation. They should check the following:

- Any installed charging equipment and its connection to the building wiring.
- The building wiring, including any wall outlet used with a Mobile Connector.
- The electrical connection to the power utility line where it enters the building.

Discuss with the electrician whether the charge current on the vehicle should be lowered, or if the installation should be upgraded to support a higher charge current.

As this alert is usually specific to external charging equipment and power sources, and it does not typically indicate an issue with your vehicle that can be resolved by scheduling service, it is recommended that you:

- Try charging with multiple, different types of charging equipment at different locations.
- Contact an electrician to inspect the wiring and equipment at your normal charging location.

You can also try charging your vehicle using a Tesla Supercharger or Destination Charging location, all of which can be located through the map on your vehicle's touchscreen display. See [Range Assurance on page 72](#) for more details. Additional third-party charging stations may also be available in your area to help you to pinpoint the issue.

For more information on troubleshooting Mobile Connector or Wall Connector status lights, refer to the product's Owner's Manual at [Charging & Adapter Product Guides](#). If using other external charging equipment, refer to the manufacturer's provided documentation for troubleshooting tips.

(CHG_u002) Unable to charge Check for an extension cord or bad utility wiring

Charging has been interrupted because the onboard charger in your vehicle has detected an unusually large voltage drop.

Likely causes of this issue include:

- Problems with the building wiring and/or the wall outlet.
- An extension cord or other wiring that cannot support the requested charge current.

This issue can also result from turning on electric devices that draw a lot of power from the same branch circuit while the vehicle is charging.

If this issue has occurred multiple times at your normal charging location, contact an electrician to inspect the electrical installation. They should check the following:

- Any installed charging equipment and its connection to the building wiring.
- The building wiring, including any wall outlet used with a Mobile Connector.
- The electrical connection to the power utility line where it enters the building.

Discuss with the electrician whether the charge current on the vehicle should be lowered, or if the installation should be upgraded to support a higher charge current.

As this alert is usually specific to external charging equipment and power sources, and it does not typically indicate an issue with your vehicle that can be resolved by scheduling service, it is recommended that you:

- Try charging with multiple, different types of charging equipment at different locations.
- Contact an electrician to inspect the wiring and equipment at your normal charging location.

You can also try charging your vehicle using a Tesla Supercharger or Destination Charging location, all of which can be located through the map on your vehicle's touchscreen display. See [Range Assurance on page 72](#) for more details. Additional third-party charging stations may also be available in your area to help you to pinpoint the issue.

For more information on troubleshooting Mobile Connector or Wall Connector status lights, refer to the product's Owner's Manual at [Charging & Adapter Product Guides](#). If using other external charging equipment, refer to the manufacturer's provided documentation for troubleshooting tips.

(CHG_u004) AC charging interrupted Check power source and charging equipment

Power has been lost during charging. This could result from the charging equipment losing power from the source (for example, a wall outlet) or from an issue with the charging equipment.

This alert is often accompanied by other alerts that can help you identify and troubleshoot the issue. Start by investigating any other displayed alerts that relate to charging issues.

Alternatively, you can check Mobile Connector or Wall Connector status lights to confirm power to the device, and also refer to the product owner's manual for troubleshooting information based on blink codes. If using other (non-Tesla) external charging equipment, check for a display or other user interface that provides troubleshooting help.

If there is clearly no power to the charging equipment, check the circuit breaker for the wall outlet / Wall Connector to make sure it has not tripped.

Further troubleshooting tips based on equipment type:

- If using a Mobile Connector, try charging the vehicle with a different wall outlet.
 - If the vehicle starts to charge, the issue was likely with the original wall outlet. It is recommended that you contact an electrician to inspect the building wiring connection to that outlet.
 - If the vehicle still does not charge, the issue may be with the Mobile Connector.
- If using a Wall Connector, try charging the vehicle with different charging equipment like a Mobile Connector powered by a separate wall outlet.

- If the vehicle starts to charge, the issue was likely with the Wall Connector. Contact an electrician to inspect the building wiring connection to the Wall Connector. They should make sure that all wires are properly connected and torqued according to the installation guide for the Wall Connector.

As this alert is usually specific to external charging equipment and power sources, and it does not typically indicate an issue with your vehicle that can be resolved by scheduling service, it is recommended that you:

- Try charging with different wall outlets.
- Try charging with different charging equipment.

You can also try charging your vehicle using a Tesla Supercharger or Destination Charging location, all of which can be located through the map on your vehicle's touchscreen display. See [Range Assurance on page 72](#) for more details. Additional third-party charging stations may also be available in your area to help you to pinpoint the issue.

For more information on troubleshooting Mobile Connector or Wall Connector status lights, refer to the product's Owner's Manual at [Charging & Adapter Product Guides](#). If using other external charging equipment, refer to the manufacturer's provided documentation for troubleshooting tips.

(CHG_u005) Unable to charge - Charge station not powered Check power source or try a different station

Charging cannot begin because the charging equipment is not ready. A charge handle is detected, but the charging station is not communicating with the vehicle. This issue could occur because:

- The charging station is not powered.
- The control pilot signal between the charging station and the vehicle is interrupted.

Try charging the vehicle with different charging equipment or at a different charging station.

If the vehicle starts to charge, the issue was likely with the equipment.

If using a Tesla Mobile Connector or Wall Connector, first check the status lights on the front. If no status lights are visible, check the power source and contact an electrician to inspect the building wiring connection to the wall outlet or the Wall Connector to confirm that all wires are properly connected and torqued.



If using other external charging equipment, consult the product's owner's manual to learn how to confirm that the station is powered. Contact an electrician to inspect the building wiring and charging equipment as necessary.

If the vehicle still does not charge, the issue may be with the vehicle.

As this alert is usually specific to external charging equipment and power sources, and it does not typically indicate an issue with your vehicle that can be resolved by scheduling service, it is recommended that you:

- Try charging with different charge equipment / at different stations.

You can also try charging your vehicle using a Tesla Supercharger or Destination Charging location, all of which can be located through the map on your vehicle's touchscreen display. See [Range Assurance on page 72](#) for more details. Additional third-party charging stations may also be available in your area to help you to pinpoint the issue.

For more information on troubleshooting Mobile Connector or Wall Connector status lights, refer to the product's Owner's Manual at [Charging & Adapter Product Guides](#). If using other external charging equipment, refer to the manufacturer's provided documentation for troubleshooting tips.

(CHG_u007) Charging equipment reports error Check equipment for error code or message

Charging was interrupted because the external charging equipment has reported a fault that prevents the vehicle from charging.

Inspect the external charging equipment and look for status lights, displays, or other status indicators on the equipment. Consult the equipment owner's manual for further troubleshooting instructions.

Try charging the vehicle with different charging equipment or at a different charging station.

- If the vehicle starts to charge, the issue was likely with the equipment.
- If the vehicle still does not charge, the issue may be with the vehicle.

As this alert is usually specific to external charging equipment and power sources, and it does not typically indicate an issue with your vehicle that can be resolved by scheduling service, it is recommended that you:

- Try charging with different charge equipment / at different stations.

You can also try charging your vehicle using a Tesla Supercharger or Destination Charging location, all of which can be located through the map on your vehicle's touchscreen display. See [Range Assurance on page 72](#) for more details. Additional third-party charging stations may also be available in your area to help you to pinpoint the issue.

For more information on troubleshooting Mobile Connector or Wall Connector status lights, refer to the product's Owner's Manual at [Charging & Adapter Product Guides](#). If using other external charging equipment, refer to the manufacturer's provided documentation for troubleshooting tips.

(CHG_u013) Charging equipment communication lost Check power source and charging equipment

Charging stopped because communication between the vehicle and the external charging equipment was interrupted.

Confirm whether the external charging equipment is powered by looking for any status lights, displays, or other indicators on the equipment.

If the equipment is **not** powered, try to restore the external charging equipment's power source.

- If attempting to charge at a public station and power is unable to be restored, contact the station operator.
- If attempting to charge at a private station (for example: charging at home) and power is unable to be restored, contact an electrician.

If the equipment is powered, try charging the vehicle using different external charging equipment.

- If the vehicle begins charging, the issue was likely with the equipment.
- If the vehicle still does not charge, the issue may be with the vehicle.

As this alert is usually specific to external charging equipment and power sources, and it does not typically indicate an issue with your vehicle that can be resolved by scheduling service, it is recommended that you:

- Make sure the external charging equipment is powered.
- Try charging with multiple, different types of charging equipment.

You can also try charging your vehicle using a Tesla Supercharger or Destination Charging location, all of which can be located through the map on your vehicle's touchscreen display. See [Range Assurance on page 72](#) for more details. Additional third-party charging stations may also be available in your area to help you to pinpoint the issue.

For more information on troubleshooting Mobile Connector or Wall Connector status lights, refer to the product's Owner's Manual at [Charging & Adapter Product Guides](#). If using other external charging equipment, refer to the manufacturer's provided documentation for troubleshooting tips.

(CHG_u014) Charging equipment reports error Check equipment for error code or message

Charging was interrupted because the external charging equipment has reported a fault that prevents the vehicle from charging.

Inspect the external charging equipment and look for status lights, displays, or other status indicators on the equipment. Consult the equipment owner's manual for further troubleshooting instructions.

Try charging the vehicle with different charging equipment or at a different charging station.

- If the vehicle starts to charge, the issue was likely with the equipment.
- If the vehicle still does not charge, the issue may be with the vehicle.

As this alert is usually specific to external charging equipment and power sources, and it does not typically indicate an issue with your vehicle that can be resolved by scheduling service, it is recommended that you:

- Try charging with different charge equipment / at different stations.

You can also try charging your vehicle using a Tesla Supercharger or Destination Charging location, all of which can be located through the map on your vehicle's touchscreen display. See [Range Assurance on page 72](#) for more details. Additional third-party charging stations may also be available in your area to help you to pinpoint the issue.

For more information on troubleshooting Mobile Connector or Wall Connector status lights, refer to the product's Owner's Manual at [Charging & Adapter Product Guides](#). If using other external charging equipment, refer to the manufacturer's provided documentation for troubleshooting tips.

(CHG_w032) Charging speed reduced High temperature detected by Wall Connector

High temperature detected by Wall Connector alerts indicate the building connection to the Wall Connector is getting too warm, so charging has been slowed to protect the wiring and Wall Connector.

This is not typically an issue with your vehicle or your Wall Connector, but rather an issue with the building wiring. This may be caused by a loose building wiring connection to the Wall Connector and can be fixed quickly by an electrician.

To regain normal charge speed, contact an electrician to inspect the building wiring connection to the Wall Connector. They should make sure that all wires are properly connected and torqued according to the installation guide for the Wall Connector.

Wall Connector installation guides can be found [here](#).

(CHG_w037) Charging stopped High temperature detected by Wall Connector

High temperature detected by Wall Connector alerts indicate the building connection to the Wall Connector is getting too warm, so charging has stopped to protect the wiring and Wall Connector.

This is not typically an issue with your vehicle or your Wall Connector, but rather an issue with the building wiring. This may be caused by a loose building wiring connection to the Wall Connector and can be fixed quickly by an electrician.

To regain normal charge operation, contact an electrician to inspect the building wiring connection to the Wall Connector. They should make sure that all wires are properly connected and torqued according to the installation guide for the Wall Connector.

Wall Connector installation guides can be found [here](#).



(CP_w054) Charge port latch not engaged Fully insert charge cable or check for obstruction

The charge port latch is unable to latch the charge cable in the charge port inlet. If the latch is not engaged, AC charging (for example, charging with a Tesla Mobile Connector or Wall Connector) will be limited to 16A and DC Fast Charging / Supercharging will be unavailable.

The charge port light will pulse amber if this alert appears during AC charging and will be solid amber if this alert appears when attempting to DC Fast Charge / Supercharge.

Try re-inserting the charge cable fully into the charge port inlet.

- If the vehicle begins charging and the charge port light pulses green, the charge cable may not have been fully inserted. The latch may not have engaged during previous attempts, because the cable was not fully inserted, even though it may have appeared to be. AC charging should no longer be limited and DC Fast Charging / Supercharging should be possible.
- If charging is still limited or the vehicle does NOT charge, inspect the charge port inlet and the charge cable connector for any obstructions (use flashlight as necessary). Debris, and/or foreign objects present in the charge port inlet or the charge cable connector can prevent the charge cable from being fully inserted and the charge port latch from engaging. If any obstruction is found:
 1. Remove the debris / foreign object.
 2. Try re-inserting the cable into the inlet. AC charging should no longer be limited and DC Fast Charging / Supercharging should be possible.

As this alert is usually specific to external charging equipment and power sources, and it does not typically indicate an issue with your vehicle that can be resolved by scheduling service, it is recommended that you:

- Make sure the charge cable is fully inserted during charging.
- Make sure any charge port inlet obstruction has been removed.

You can also try charging your vehicle using a Tesla Supercharger or Destination Charging location, all of which can be located through the map on your vehicle's touchscreen display. See [Range Assurance on page 72](#) for more details. Additional third-party charging stations may also be available in your area to help you to pinpoint the issue.

For more information on troubleshooting Mobile Connector or Wall Connector status lights, refer to the product's Owner's Manual at [Charging & Adapter Product Guides](#). If using other external charging equipment, refer to the manufacturer's provided documentation for troubleshooting tips.

For more information on charging, see [Charging Instructions on page 155](#).

(DI_w039) Regenerative braking temporarily reduced Will improve as vehicle is driven

Regenerative braking performance has been temporarily reduced to below 65% of its full capacity. The exact reduction is indicated by the dashed lines on the power meter:

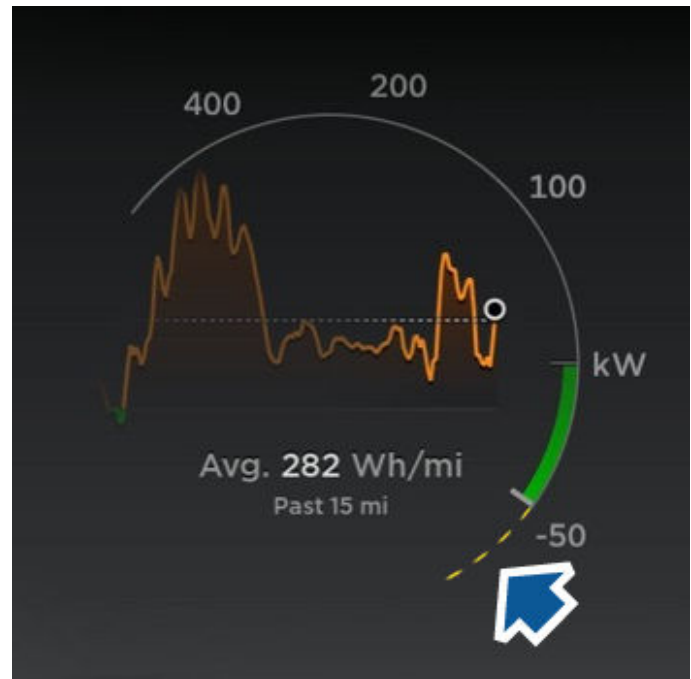

While this alert is present, the deceleration rate of the vehicle due to regenerative braking will be reduced and more brake pedal application will be required to slow the vehicle (similar to what is needed in a gas-powered, non-electric, vehicle).

This alert is expected under the following conditions:

- Battery is near full charge:
 - Regenerative braking is reduced when the battery is at 95% charge or higher.
- Battery is cold:
 - The battery may not be warm enough for full regenerative braking performance (possibly at the beginning of a drive).



Troubleshooting Alerts

- In extremely cold climates, this alert may remain present indefinitely and regenerative braking may remain reduced, as driving the vehicle may not warm the battery enough to fully restore performance.

Typically, driving will clear this alert because it will reduce the battery charge level below 95% and sufficiently warm the battery.

This is a completely normal part of vehicle operation and should not cause alarm. The notice on the screen is for your information only.

For more information on regenerative braking, see the Regenerative Braking section in the Owner's Manual. [Regenerative Braking on page 60.](#)

(DI_w172) Powertrain requires service Avoid hard acceleration

An issue has been detected in the powertrain system. The vehicle is OK to drive, but you should schedule service as soon as possible for a powertrain inspection.

Your vehicle has detected excessive backlash (lash) between the drive unit and the wheels. High, or excessive, lash is indicative of mechanical wear.

There are many possible causes, so a powertrain inspection is needed.

Your vehicle is OK to drive to your immediate destination and to a service center. Avoid hard or heavy acceleration, as this puts more stress on the powertrain.

Schedule a service appointment at your earliest opportunity. If this issue is not addressed, your vehicle might unexpectedly stop while you are driving.

(GTW_w017) Electrical system power reduced Vehicle may shut down unexpectedly

The electrical system cannot maintain the voltage required to support all vehicle features.

If you drive the vehicle while this alert is present, certain features may be disabled or function at a reduced level due to the low voltage. It is also possible the vehicle will shut down unexpectedly.

Try turning off non-critical features, like seat heaters or cabin fans, to help the vehicle maintain electrical power for as long as possible.

Eliminating or reducing usage of non-critical features may allow the vehicle to reach its destination without shutting down, although this is not guaranteed.

Schedule service before your next planned drive. The vehicle may shut down unexpectedly or may not restart without service.

(GTW_w018) Electrical system power reduced Vehicle may shut down unexpectedly

The electrical system cannot maintain the voltage required to support all vehicle features.

If you drive the vehicle while this alert is present, certain features may be disabled or function at a reduced level due to the low voltage. It is also possible the vehicle will shut down unexpectedly.

Try turning off non-critical features, like seat heaters or cabin fans, to help the vehicle maintain electrical power for as long as possible.

Eliminating or reducing usage of non-critical features may allow the vehicle to reach its destination without shutting down, although this is not guaranteed.

Schedule service before your next planned drive. The vehicle may shut down unexpectedly or may not restart without service.

(GTW_w174) 12V battery must be replaced soon Software updates will not complete until serviced

The 12V battery has aged or degraded and needs to be replaced. Until the battery is replaced, vehicle software updates will not complete.

It is recommended to replace the battery at your earliest convenience. In the meantime, continue normal use of the vehicle.

The vehicle is still OK to drive with this alert present, for a period of time. However, if you continually delay the 12V battery replacement, the vehicle may eventually not have enough power to start or restart.

If the 12V battery is too low to turn on the vehicle or open the doors, see [Battery Care on page 154](#) for recommended actions.

For more information on the battery system, see [Battery Information on page 154.](#)



(GTW_w360)
Assist for low brake performance activated
To stop, keep brake pedal firmly pressed

Hydraulic Fade Compensation is active. This brake assist function activates temporarily to make sure you have full braking capability in conditions where reduced braking performance is detected by your vehicle.

Continue to press the brake pedal as you normally would, and do not "pump" (repeatedly press and release) the pedal as this will interrupt the function.

This alert will clear when your vehicle comes to a stop or you are no longer pressing the brake pedal. It may still be displayed for up to 5 seconds afterward.

When this assist function activates, you may feel the brake pedal pull away from your foot and notice a strong increase in brake pressure. You may also hear a pumping sound coming from the brake hydraulic unit at the front of the vehicle. This will usually last for a few seconds, depending on road surface and vehicle speed. This is completely normal and does not indicate any issue with your vehicle.

Reduced braking performance is usually temporary, and can occur for a number of reasons including high brake temperatures after heavy brake use, or driving in extremely cold or wet conditions. It can also indicate that your brake pads or rotors have worn to the point that normal replacement is needed.

If you continue to experience reduced braking performance which does not improve over time, please contact Tesla service at your convenience for a brake inspection.

For more information, see [Hydraulic Fade Compensation on page 59](#).

(MCU_w008)
Air pressure in tires very low
PULL OVER SAFELY - Check for flat tire

This alert indicates that one or more of the tires on your vehicle is extremely low or flat.

The tire pressure monitoring system (TPMS) has detected that the air pressure in one or more of your tires is significantly lower than the recommended cold pressure (RCP). This recommended pressure is displayed on the Tire and Loading information label.

You should pull over carefully as soon as possible. In a safe location, check for a flat tire.

You can request Tesla roadside assistance options (mobile tire, loaner wheel, tow) if required. See [Contacting Tesla Roadside Assistance on page 188](#) for more information.

In a non-emergency situation, it is recommended that you visit your local Service Center for assistance.

The alert will clear once the TPMS has a consistent tire pressure measurement for each of your tires within 3 psi of the recommended cold pressure.

For more information on tire pressure, inflation, and maintenance, see [Tire Care and Maintenance on page 162](#).

(MCU_w010)
Air pressure below recommendation for tires
Check pressure and refill air as needed

This alert does NOT indicate that there is a flat tire.

The tire pressure monitoring system (TPMS) has detected that the air pressure in one or more of your tires is at least 20% lower than the recommended cold tire pressure. This recommended pressure should be displayed on the Tire and Loading information label.

See [Maintaining Tire Pressures on page 162](#) for detailed information on how to keep the tires properly inflated.

This alert may appear in cold weather because the tire pressure decreases when cold.

- Although drops in tire pressure are expected in colder weather, air should still be added to maintain the recommended cold tire pressure.
- The alert may clear as the vehicle is driven. This is because the tires will warm up and the tire pressure will increase.
 - Even if the alert clears, the tires should still be refilled with air once they have cooled. The recommended cold tire pressure should be maintained.

If you repeatedly see this alert for the same tire, have the tire inspected for a slow leak.

For more information on tire pressure and inflation, see [Tire Care and Maintenance on page 162](#).

(THC_u0005)

Air conditioning temporarily reduced Vehicle systems being cooled

Cabin air conditioning performance has been temporarily reduced because your vehicle needs to focus on cooling the high voltage battery (Battery) and/or powertrain. This is completely normal and does not indicate a problem with your vehicle or the air conditioning (A/C) system.

In addition to cooling the vehicle interior, the A/C system also cools the Battery. The A/C system's priority is to cool the Battery to make sure it stays within an optimal temperature range that supports longevity and best performance.

In high temperature environments, it is normal for your vehicle to focus more for brief periods on cooling the Battery. When this happens, it is most often because the vehicle is supercharging in hot weather.

No action is required. Your vehicle is OK to drive.

The alert should clear in a short time, and cabin air conditioning performance should return to normal. In some cases, the alert and vehicle behavior will continue until supercharging is complete.

If the alert persists over multiple drives and is accompanied by other alerts that indicate potential issues with the A/C system, contact Tesla Service at your convenience to schedule an A/C system inspection.

(UMC_w002)

Unable to charge - Mobile Connector GFCI tripped Disconnect and retry or use different equipment

The vehicle cannot charge because the ground-fault circuit interrupter (GFCI) in the Mobile Connector has tripped.

Like the GFCI in a wall outlet, this feature is designed to stop the flow of electricity when there is a problem. It has interrupted charging to protect your vehicle and the charging equipment.

This could happen for many reasons. The problem could be in the charge cable, the charge handle, the charge port, or even an onboard vehicle component.

Inspect the charge port as well as the charge handle for pooled water or unusual levels of moisture.

- If you find excessive moisture, wait and let both the inside area of the charge port and the exposed portion of the charge handle dry sufficiently before trying again.

Inspect the charge equipment for damage.

- If the cable is in any way damaged or deteriorated, **do not use it**. Try different charging equipment instead.
- If the cable is in good condition, try charging again with the same Mobile Connector.

If the issue persists and prevents charging, try charging with different charging equipment.

As this alert is usually specific to external charging equipment and power sources, and it does not typically indicate an issue with your vehicle that can be resolved by scheduling service, it is recommended that you:

- Try charging with multiple, different types of charging equipment.

You can also try charging your vehicle using a Tesla Supercharger or Destination Charging location, all of which can be located through the map on your vehicle's touchscreen display. See [Range Assurance on page 72](#) for more details. Additional third-party charging stations may also be available in your area to help you to pinpoint the issue.

For more information on troubleshooting Mobile Connector status lights and charging issues, refer to the [product's owner's manual](#).

(UMC_w004)

Unable to charge with Mobile Connector Voltage too high / Try a different wall outlet

The vehicle cannot charge, or charging is interrupted, because **either** the Mobile Connector:

- Detects the wall outlet voltage is too high.

OR

- Detects an unexpected increase in supply voltage from the wall outlet.

Try charging the vehicle with a different wall outlet.

If the vehicle starts to charge, the issue was likely with the original wall outlet. It is recommended that you contact an electrician to inspect the building wiring connection to that outlet.



If the vehicle still does not charge when you try a different wall outlet, try charging at a different location.

As this alert is usually specific to external charging equipment and power sources, and it does not typically indicate an issue with your vehicle that can be resolved by scheduling service, it is recommended that you:

- Try charging with different wall outlets.
- Try charging with different charging equipment.

You can also try charging your vehicle using a Tesla Supercharger or Destination Charging location, all of which can be located through the map on your vehicle's touchscreen display. See [Range Assurance on page 72](#) for more details. Additional third-party charging stations may also be available in your area to help you to pinpoint the issue.

For more information on troubleshooting Mobile Connector status lights and charging issues, refer to the [product's owner's manual](#).

(UMC_w005) Unable to charge with Mobile Connector Voltage too low / Try a different wall outlet

The vehicle cannot charge, or charging is interrupted, because **either** the Mobile Connector:

- Does not detect enough supply voltage from the wall outlet.

OR

- Detects an unexpected drop in supply voltage from the wall outlet.

Try charging the vehicle with a different wall outlet.

If the vehicle starts to charge, the issue was likely with the original wall outlet. It is recommended that you contact an electrician to inspect the building wiring connection to that outlet.

If the vehicle still does not charge when you try a different wall outlet, try charging at a different location.

As this alert is usually specific to external charging equipment and power sources, and it does not typically indicate an issue with your vehicle that can be resolved by scheduling service, it is recommended that you:

- Try charging with different wall outlets.
- Try charging with different charging equipment.

You can also try charging your vehicle using a Tesla Supercharger or Destination Charging location, all of which can be located through the map on your vehicle's touchscreen display. See [Range Assurance on page 72](#) for more details. Additional third-party charging stations may also be available in your area to help you to pinpoint the issue.

For more information on troubleshooting Mobile Connector status lights and charging issues, refer to the [product's owner's manual](#).

(UMC_w008) Charging stopped High temperature detected by Mobile Connector

High temperature detected by Mobile Connector alerts indicate the outlet used to charge is becoming too warm, so charging has stopped to protect the outlet.

This is not typically an issue with your vehicle or your Mobile Connector, but rather an issue with the outlet. A warm outlet may be caused by a plug that is not fully inserted, a loose building wiring connection to the outlet, or an outlet that is beginning to wear out.

To regain normal charge operation, make sure your adapter is fully plugged into the outlet. If charging speed does not return to normal, contact an electrician to inspect the outlet and building wiring connections to the outlet and complete any repairs needed.

If the outlet is worn, it should be replaced with a high-quality outlet. Consider upgrading to a Tesla Wall Connector for greater convenience and highest charging speed.

(UMC_w017) Charging speed reduced High temperature detected by Mobile Connector

High temperature detected by Mobile Connector alerts indicate the outlet used to charge is becoming too warm, so charging has been slowed to protect the outlet.

This is not typically an issue with your vehicle or your Mobile Connector, but rather an issue with the outlet. A warm outlet may be caused by a plug that is not fully inserted, a loose building wiring connection to the outlet, or an outlet that is beginning to wear out.

To regain normal charge speed, make sure your adapter is fully plugged into the outlet. If charging speed does not return to normal, contact an electrician to inspect the outlet and building wiring connections to the outlet and complete any repairs needed.



Troubleshooting Alerts

If the outlet is worn, it should be replaced with a high-quality outlet. Consider upgrading to a Tesla Wall Connector for greater convenience and highest charging speed.

A

ABS (Anti-lock Braking System): 59
absolute speed limit: 115
Acceleration settings: 67
access panel, removing: 171
accessories: 20
 plugging into power socket: 20
active hood: 69
adaptive headlights: 50
adjacent lane speed: 109
air circulation: 124
air conditioning: 123
air distribution: 124
air filter: 127
air vents: 126
airbags: 34
alarm: 141
all-season tires: 165
always connected, setting: 72
Always Show Estimated Round Trip Energy: 130
anti-lock braking (ABS): 59
application launcher: 5
audio: 39, 133, 135
 equalizer: 135
 immersive sound: 135
 playing files: 133
 steering wheel buttons: 39
 volume control: 133
Auto High Beam: 50
Auto Lane Change: 89
automatic emergency braking: 113
automatic navigation: 128
Autopark: 101
autopilot: 109
 blind spot collision warning: 109
 side collision warning: 109
Autopilot: 79, 82, 87, 89, 101, 103, 112, 115
 Auto Lane Change: 89
 automatic emergency braking: 112
 Autopark: 101
 Autosteer: 87
 collision avoidance assist: 112
 forward collision warning: 112
 overtake acceleration: 82
 overview: 79
 speed assist: 115
 speed limit warning: 115
 staying within speed limits: 115
 Summon: 103

Traffic-Aware Cruise Control: 82

Autopilot components: 79

Autosteer: 87

average range: 71

B

backup camera: 73

battery (12V): 154, 182

 complete discharge: 154

 specifications: 182

Battery (high voltage): 154, 171, 182

 care of: 154

 coolant: 171

 specifications: 182

 temperature limits: 154

battery (key), replacing: 11

blind spot collision warning: 109

Bluetooth: 134, 136

 devices, playing audio files from: 134

 general information: 136

 phone, pairing and using: 136

body repairs: 175

body touch up: 169

brakes: 59, 113, 171, 182

 automatic in emergencies: 113

 fluid level: 171

 overview of: 59

 specifications: 182

Bumper Clearance (Summon): 103

C

cabin air filter: 127

cabin temperature control: 123

Calendar app: 140

camera (rear view): 73

cameras (autopilot): 79

Camp Mode: 126

car cover: 169

car status, displaying: 39, 40

car washes: 167

cargo area: 16

cargo volume: 181

carpets, cleaning: 168

CCS (Combo): 153

CE certifications: 196

CHAdEMO: 153

chains: 166

change of ownership: 122

charge port: 155



- charge port light: [157](#)
- charge port manual release: [156](#)
- charge port release lever: [156](#)
- charging: [152](#), [153](#), [155](#), [157](#), [159](#)
 - charge settings: [157](#)
 - components and equipment: [152](#)
 - instructions: [155](#)
 - public charging stations: [153](#)
 - scheduling: [157](#)
 - status of: [159](#)
- charging locations, finding: [130](#)
- child protection: [14](#)
 - disabling rear window switches: [14](#)
- child seats: [27](#)
 - installing and using: [27](#)
- child-protection: [12](#)
 - disabling liftgate and rear door handles: [12](#)
- Chill acceleration: [67](#)
- cleaning: [167](#)
- climate controls: [123](#)
- cold weather best practices: [77](#)
- collision avoidance assist: [112](#)
- connecting to Wi-Fi: [147](#)
- console: [19](#), [20](#), [21](#)
 - 12V power socket: [20](#)
 - cup holders: [21](#)
 - USB ports: [19](#)
- consumption chart: [71](#)
- contact information: [189](#)
 - roadside assistance: [189](#)
- copyrights: [193](#)
- Creep: [60](#)
- cruise control: [82](#)
- cup holders: [21](#)

D

- dashboard overview: [2](#)
- Dashcam: [74](#)
- data recording: [194](#)
- data sharing: [194](#)
- declarations of conformity: [196](#)
- delivery mileage: [194](#)
- devices: [19](#), [134](#)
 - Bluetooth, playing audio files: [134](#)
 - connecting: [19](#)
 - playing audio files from: [134](#)
- dimensions: [179](#)
- Dog Mode: [126](#)
- dome (map) lights: [48](#)

- door handles: [11](#)
- door labels: [177](#)
- Door Unlock Mode: [12](#)
- doors: [10](#)
- doors, opening: [10](#)
- drive away locking: [12](#)
- Drive gear: [46](#)
- driver: [23](#), [37](#)
 - profiles: [37](#)
 - seat adjustment: [23](#)
- driving: [23](#), [44](#), [71](#)
 - seating position: [23](#)
 - starting: [44](#)
 - tips to maximize range: [71](#)

E

- Easter Eggs: [193](#)
- easy entry, driver profile: [37](#)
- electric parking brake: [61](#)
- emergency braking: [112](#)
- emergency flashers: [51](#)
- Emergency Lane Departure Avoidance: [109](#)
- emergency rear door opening: [13](#)
- energy: [52](#), [60](#)
 - gained from regenerative braking: [60](#)
 - range information: [52](#)
- Energy app: [71](#)
- energy saving mode: [72](#)
- energy use predictions (navigating): [130](#)
- Erase & Reset: [122](#)
- event data recording: [194](#)
- exterior: [4](#), [48](#), [167](#), [169](#), [179](#)
 - car cover: [169](#)
 - cleaning: [167](#)
 - dimensions: [179](#)
 - lights: [48](#)
 - overview: [4](#)
 - polishing, touch up, & repair: [169](#)

F

- factory defaults, restoring: [122](#)
- factory reset: [122](#)
- fan speed, interior: [124](#)
- favorites (Media Player): [134](#)
- Favorites (navigation): [129](#)
- FCC certifications: [196](#)
- features, downloading new: [148](#)
- firmware (software) updates: [148](#)
- flash drives, playing audio files from: [134](#)

flashers, warning: [51](#)
floor mats: [169](#)
fluids: [160](#), [171](#)

- replacement intervals: [160](#)
- reservoirs, checking: [171](#)

fog lights: [48](#)
forward collision warning: [112](#)
front passenger detection: [35](#)
front trunk: [17](#)

G

garage doors, opening: [145](#)
gates, opening: [145](#)
GAWR: [177](#)
gears: [46](#)
glovebox: [19](#)
Glovebox PIN: [141](#)
Gross Axle Weight Rating: [177](#)
Gross Vehicle Weight Rating: [177](#)
ground clearance: [179](#)
GVWR: [177](#)

H

hazard warning flashers: [51](#)
headlights: [48](#), [50](#)

- adaptive: [50](#)
- after exit: [50](#)
- high beams: [50](#)

heated wipers: [58](#)
heating: [123](#)
height adjustments (suspension): [174](#)

- disabling (Jack mode): [174](#)

high beam headlights: [50](#)
high voltage: [152](#), [160](#), [182](#)

- Battery specifications: [182](#)
- components: [152](#)
- safety: [160](#)

hills, stopping on: [66](#)
hitches: [178](#)
Hold: [60](#)
Home location: [131](#)
HomeLink: [103](#), [145](#), [198](#)

- FCC certification: [198](#)
- programming and using: [145](#)
- when using Summon: [103](#)

hood: [17](#)
horn: [41](#)

I

I'm Feeling Lucky, Hungry: [128](#)
IC certifications: [196](#)
identification labels: [176](#)
inductive phone charger: [19](#)
Insane acceleration: [67](#)
instant range: [71](#)
instrument panel: [52](#), [159](#), [168](#)

- charging status: [159](#)
- cleaning: [168](#)
- overview of: [52](#)

interior: [2](#), [48](#), [123](#), [168](#), [179](#)

- cleaning: [168](#)
- dimensions: [179](#)
- lights: [48](#)
- overview: [2](#)
- temperature control: [123](#)

internet radio: [133](#)
intrusion detection: [141](#)
ISOFIX child seats, installing: [30](#)

J

J1772: [153](#)
Jack mode: [174](#)
jacking: [174](#)

K

Keep Climate On: [126](#)
key: [10](#), [11](#), [44](#), [196](#)

- FCC and IC certifications: [196](#)
- how to use: [10](#)
- key not inside: [44](#)
- ordering extras: [11](#)
- replacing battery: [11](#)

keyless entry: [10](#)

L

label: [177](#)

- Statutory Plate: [177](#)
- Tire and Loading Information: [177](#)

lane assist: [109](#)
lane change, automatic: [89](#)
Lane Departure Avoidance: [109](#)
Launch Mode: [67](#)
liftgate: [15](#)

- adjust opening height: [15](#)
- opening: [15](#)



lifting: [174](#)
lights: [48](#), [50](#), [51](#)

- adaptive headlights: [50](#)
- hazard warning: [51](#)
- headlights after exit: [50](#)
- turn signals: [50](#)

load limits: [177](#)
location tracking: [128](#)
locking and unlocking doors: [10](#)
Ludicrous acceleration: [67](#)
lumbar adjustment: [23](#)

M

maintenance: [160](#), [162](#), [167](#), [170](#), [171](#), [172](#)

- brake fluid, checking: [171](#)
- cleaning: [167](#)
- daily checks: [160](#)
- fluid replacement intervals: [160](#)
- monthly checks: [160](#)
- panel, removing: [171](#)
- replacing wiper blades: [170](#)
- service intervals: [160](#)
- tires: [162](#)
- washer fluid, topping up: [172](#)
- washer jets, cleaning: [170](#)

map orientation: [128](#)
map updates: [132](#)
mats: [169](#)
media: [133](#)
mileage upon delivery: [194](#)
mirrors: [42](#)
mobile app: [150](#)
mobile app access: [150](#)
Mobile Connector: [153](#), [155](#)

- description: [153](#)
- using: [155](#)

modifications: [175](#)
motor specifications: [181](#)
my car does what?: [193](#)

N

naming: [122](#)
Navigate on Autopilot: [91](#)
navigating: [128](#), [129](#)
NCC certifications: [196](#)
Neutral gear: [46](#)

O

Obstacle-Aware Acceleration: [112](#)
occupancy sensor: [35](#)
odometer: [9](#), [70](#)
offset from speed limit: [115](#)
Online Routing: [131](#)
overhang dimensions: [179](#)
overtake acceleration: [82](#)
Owner Information, about: [193](#)

P

Park Assist: [64](#)
Park gear: [46](#)
parking brake: [61](#)
parking, using Autopark: [101](#)
parking, using Summon: [103](#)
parts replacement: [175](#)
passenger detection: [35](#)
passenger front airbag: [35](#)
pedestrian protection: [69](#)
personal data, erasing: [122](#)
phone: [40](#), [136](#)

- steering wheel buttons: [40](#)
- using: [136](#)

phone app: [137](#)
PIN: [38](#)
PIN to Drive: [141](#)
power cycling: [44](#)
power management: [72](#)
power socket: [20](#)
power windows: [14](#)
powering on and off: [44](#)
public charging stations: [153](#)

R

radar: [79](#)
radio: [133](#)
Radio Frequency information: [196](#)
range: [52](#), [60](#), [71](#)

- displayed on instrument panel: [52](#)
- driving tips to maximize: [71](#)
- regenerative braking: [60](#)

range assurance: [72](#)
Range mode: [71](#)
Re-route: [131](#)
rear seats, folding and raising: [24](#)
rear view camera: [73](#)
rear window switches, disabling: [14](#)

recent (Media Player): [134](#)
Recents (navigation): [129](#)
recording videos: [74](#), [143](#)
regenerative braking: [60](#)
relative speed limit: [115](#)
release notes: [149](#)
restarting the touchscreen: [44](#)
Reverse gear: [46](#)
RFID transponders: [175](#)
roadside assistance: [189](#)
Roll: [60](#)
roof racks: [178](#)
rotating tires: [163](#)
Round Trip Energy (navigating): [130](#)

S

safety information: [26](#), [33](#), [35](#)
 airbags: [35](#)
 child seats: [33](#)
 seat belts: [26](#)
schedule service: [150](#)
scheduled charging: [158](#)
scheduled departure: [158](#)
 using: [158](#)
seat belts: [25](#), [26](#), [168](#)
 cleaning: [168](#)
 in a collision: [26](#)
 overview of: [25](#)
 pre-tensioners: [26](#)
 wearing when pregnant: [25](#)
seat covers: [24](#)
seat heaters: [123](#)
seating capacity: [177](#)
seats: [23](#), [123](#)
 adjusting: [23](#)
 heaters: [123](#)
security settings: [141](#)
sensors: [79](#)
Sentry Mode: [141](#)
service data recording: [194](#)
service intervals: [160](#)
Settings, erasing: [122](#)
shifting gears: [46](#)
Show Calendar Upon Entry: [140](#)
Side Clearance (Summon): [103](#)
side collision warning: [109](#)
slip start: [63](#)
Smart Summon: [106](#)
Software Reinstall: [148](#)

software reset: [122](#)
software update preferences: [148](#)
software updates: [148](#)
software version: [9](#)
specifications: [179](#), [181](#), [182](#), [184](#)
 12V battery: [182](#)
 brakes: [182](#)
 cargo volume: [181](#)
 dimensions: [179](#)
 exterior: [179](#)
 High Voltage Battery: [182](#)
 interior: [179](#)
 motor: [181](#)
 steering: [182](#)
 subsystems: [181](#)
 suspension: [182](#)
 tires: [184](#)
 transmission: [181](#)
 wheels: [184](#)
speed assist: [115](#)
Speed Limit Mode: [122](#)
speed limit warning: [115](#)
Sport acceleration: [67](#)
stability control: [63](#)
Standard acceleration: [67](#)
starting: [44](#)
Statutory Plate: [177](#)
steering specifications: [182](#)
steering wheel: [39](#)
 adjusting position: [39](#)
 adjusting sensitivity: [39](#)
 buttons: [39](#)
 heated: [39](#)
 scroll buttons: [39](#)
steering, automatic: [87](#)
Stopping Mode: [60](#)
streaming services: [133](#)
summer tires: [165](#)
Summon: [103](#)
Summon Distance: [103](#)
sunroof: [22](#)
supercharging: [159](#)
 described: [159](#)
 idle fees: [159](#)
 pay-per-use fees: [159](#)
suspension specifications: [182](#)

T

telematics: [194](#)



temperature: [41](#), [52](#), [123](#), [154](#)
 Battery (high voltage), limits: [154](#)
 cabin, controls for: [123](#)
 heated steering wheel: [41](#)
 outside: [52](#)
Teslacam: [74](#)
tie-down straps: [191](#)
tilt/intrusion detection: [141](#)
Tire and Loading Information label: [177](#)
tire noise: [165](#)
Tire Pressure Monitoring System: [164](#), [197](#)
 FCC certification: [197](#)
 overview of: [164](#)
tire pressures, checking: [162](#)
tires: [162](#), [163](#), [165](#), [166](#), [184](#), [186](#)
 all-season: [165](#)
 balancing: [163](#)
 chains: [166](#)
 inspecting and maintaining: [162](#)
 pressures, how to check: [162](#)
 replacing: [163](#)
 replacing a tire sensor: [165](#)
 rotation: [163](#)
 specification: [184](#)
 summer: [165](#)
 tire markings: [186](#)
 wheel configuration: [162](#)
 winter: [165](#)
toll system transponders, attaching: [175](#)
torque specifications: [181](#)
touch up body: [169](#)
touchscreen: [5](#), [148](#), [168](#)
 cleaning: [168](#)
 overview: [5](#)
 software updates: [148](#)
tow eye, locating: [190](#)
towing: [189](#)
towing a trailer: [178](#)
towing instructions: [189](#)
TPMS: [164](#), [197](#)
 FCC certification: [197](#)
 overview of: [164](#)
Tracking Disabled: [128](#)
traction control: [63](#)
trademarks: [193](#)
Traffic Light and Stop Sign Control: [94](#)
Traffic-Aware Cruise Control: [82](#)
trailer hitches: [178](#)
transmission specifications: [181](#)
transponders, attaching: [175](#)

Transport Mode: [190](#)
transporting: [189](#)
trip chart: [71](#)
trip meter: [70](#)
Trip Planner: [131](#)
trunk, front: [17](#)
trunk, rear: [12](#), [15](#)
 child-protection lock: [12](#)
 disabling interior handle: [12](#)
turn signals: [50](#)

U

ultrasonic sensors: [79](#)
Unlock on Park: [10](#)
unlocking when key doesn't work: [13](#)
USB devices: [19](#), [134](#)
 connecting: [19](#)
 playing audio files from: [134](#)
USB flash drive: [141](#)
USB ports: [19](#)

V

Valet mode: [38](#)
Vehicle Hold: [66](#)
Vehicle Identification Number (VIN): [176](#)
vehicle loading: [177](#)
vent, sunroof: [22](#)
ventilation: [126](#)
videos and recording: [74](#), [143](#)
VIN (Vehicle Identification Number): [176](#)
voice commands: [39](#)
volume control: [5](#)
volume control (media): [133](#)

W

Walk-Away Door Lock: [12](#)
Wall Connector: [153](#)
warning flashers: [51](#)
washer fluid, topping up: [172](#)
washer jets, cleaning: [170](#)
washers, using: [58](#)
wheel chocks: [191](#)
wheels: [163](#), [184](#)
 alignment: [163](#)
 replacing: [163](#)
 specifications: [184](#)
 torque: [184](#)
Wi-Fi, connecting to: [147](#)

windshield washer fluid, topping up: [172](#)

winter tires: [165](#)

wiper blades, replacing: [170](#)

wipers, de-icing: [58](#)

wipers, using: [58](#)

wireless phone charger: [19](#)

Work location: [131](#)

TESLA

Publication date: October 29, 2020